

CS4070 SCANNER

PRODUCT REFERENCE GUIDE



CS4070 SCANNER PRODUCT REFERENCE GUIDE

MN000762A03

Revision A

March 2015

No part of this publication may be reproduced or used in any form, or by any electrical or mechanical means, without permission in writing. This includes electronic or mechanical means, such as photocopying, recording, or information storage and retrieval systems. The material in this manual is subject to change without notice.

The software is provided strictly on an “as is” basis. All software, including firmware, furnished to the user is on a licensed basis. We grant to the user a non-transferable and non-exclusive license to use each software or firmware program delivered hereunder (licensed program). Except as noted below, such license may not be assigned, sublicensed, or otherwise transferred by the user without our prior written consent. No right to copy a licensed program in whole or in part is granted, except as permitted under copyright law. The user shall not modify, merge, or incorporate any form or portion of a licensed program with other program material, create a derivative work from a licensed program, or use a licensed program in a network without written permission. The user agrees to maintain our copyright notice on the licensed programs delivered hereunder, and to include the same on any authorized copies it makes, in whole or in part. The user agrees not to decompile, disassemble, decode, or reverse engineer any licensed program delivered to the user or any portion thereof.

Zebra reserves the right to make changes to any product to improve reliability, function, or design.

Zebra does not assume any product liability arising out of, or in connection with, the application or use of any product, circuit, or application described herein. No license is granted, either expressly or by implication, estoppel, or otherwise under any patent right or patent, covering or relating to any combination, system, apparatus, machine, material, method, or process in which Zebra products might be used. An implied license exists only for equipment, circuits, and subsystems contained in Zebra products.

Warranty

For the complete hardware product warranty statement, go to: <http://www.zebra.com/warranty>.

Revision History

Changes to the original manual are listed below:

Change	Date	Description
-01 Rev A	8/2014	Initial release
-02 Rev A	12/2014	Rebranded; various updates to connection and operation information, updated default for Sleep and BTSleep, updated 123Scan2 chapter, updated index
-03 Rev A	3/2015	Updated URLs, added auto-reconnect beep description, added note to Scan Data Transmission Format

TABLE OF CONTENTS

About This Guide

Introduction	xiii
Configurations	xiii
Accessories	xiii
Chapter Descriptions	xiv
Notational Conventions	xv
Related Documents	xv
Service Information	xvi

Chapter 1: Getting Started

Introduction	1-1
Unpacking the Scanner	1-2
Inserting and Removing the Battery	1-2
Inserting the Battery	1-2
Removing the Battery	1-3
Charging Batteries	1-4
Charging the Battery in a CS4070	1-4
Charging Spare Batteries	1-4
Charging Temperature	1-4
Connecting to the Host Computer	1-5
Batch Connection	1-5
Bluetooth Connection: Development Options	1-5
Pairing	1-6
Unpairing	1-7
Deleting the CS4070 from the Device List	1-7
Configuring the Scanner	1-8
123Scan2	1-8
Parameter Bar Codes and Config.ini	1-8
Updating Scanner Firmware	1-8
Editing the Configuration File	1-9

Chapter 2: Scanning

Introduction	2-1
Scanning	2-1
Deleting Bar Codes	2-2
Transmitting Bar Code Data to Host	2-2
Transferring Data from a Batch Scanner	2-2
Transferring Data from a Bluetooth Scanner	2-3
User Interface Definitions	2-3
LED Indications	2-3
Beeper Indications	2-5

Chapter 3: User Preferences

Introduction	3-1
Scanning Sequence Examples	3-1
Errors While Scanning	3-1
User Preferences Default Parameters	3-2
Reset Factory Defaults	3-4
Set Date and Time	3-5
Set Date	3-5
Set Time	3-5
Cancel Date and Time Setting	3-5
Bluetooth Options	3-7
Master/Slave Set Up	3-7
Bluetooth Unpair	3-8
Bluetooth Profile	3-8
Clear Data	3-9
Auto-reconnect	3-10
Connection Interval	3-11
HID Security	3-11
Radio Output Power	3-12
Set HID CoD to Zero	3-12
User Preference Settings	3-13
Parameter Bar Code Scanning	3-13
Beep After Good Decode	3-13
Beeper Volume	3-14
Beeper Tone	3-15
Mute Beeper	3-15
Decode Pager Motor (CS4070HC only)	3-16
Decode Pager Motor Duration (CS4070HC only)	3-16
Picklist Mode	3-18
Fuzzy 1D Processing	3-18
Mirrored Image	3-19
Mobile Phone/Display Mode	3-19
PDF Prioritization	3-20
PDF Prioritization Timeout	3-20
Data Options	3-21
Transmit Code ID Character	3-21
Prefix/Suffix Values	3-22
Scan Data Transmission Format	3-23
Transmit "No Read" Message	3-24

Send Versions	3-25
Firmware Version	3-25
Scan Engine Version	3-25
Dongle Version	3-25

Chapter 4: Symbolologies

Introduction	4-1
Scanning Sequence Examples	4-1
Errors While Scanning	4-2
Symbology Default Parameters	4-2
Enable/Disable All Code Types	4-7
UPC/EAN	4-8
Enable/Disable UPC-A	4-8
Enable/Disable UPC-E	4-8
Enable/Disable UPC-E1	4-9
Enable/Disable EAN-8/JAN-8	4-9
Enable/Disable EAN-13/JAN-13	4-10
Enable/Disable Bookland EAN	4-10
Bookland ISBN Format	4-11
Decode UPC/EAN/JAN Supplementals	4-12
User-Programmable Supplementals	4-15
UPC/EAN/JAN Supplemental Redundancy	4-15
UPC/EAN/JAN Supplemental AIM ID Format	4-16
Transmit UPC-A Check Digit	4-17
Transmit UPC-E Check Digit	4-17
Transmit UPC-E1 Check Digit	4-18
UPC-A Preamble	4-19
UPC-E Preamble	4-20
UPC-E1 Preamble	4-21
Convert UPC-E to UPC-A	4-22
Convert UPC-E1 to UPC-A	4-22
EAN-8/JAN-8 Extend	4-23
UCC Coupon Extended Code	4-23
Coupon Report	4-24
ISSN EAN	4-24
Code 128	4-25
Enable/Disable Code 128	4-25
Set Lengths for Code 128	4-25
Enable/Disable GS1-128 (formerly UCC/EAN-128)	4-27
Enable/Disable ISBT 128	4-27
ISBT Concatenation	4-28
Check ISBT Table	4-29
ISBT Concatenation Redundancy	4-29
Code 128 Security Level	4-30
Code 39	4-31
Enable/Disable Code 39	4-31
Enable/Disable Trioptic Code 39	4-31
Convert Code 39 to Code 32	4-32
Code 32 Prefix	4-32
Set Lengths for Code 39	4-33

Code 39 Check Digit Verification	4-34
Transmit Code 39 Check Digit	4-34
Code 39 Full ASCII Conversion	4-35
Code 39 Security Level	4-36
Code 93	4-37
Enable/Disable Code 93	4-37
Set Lengths for Code 93	4-37
Code 11	4-39
Code 11	4-39
Set Lengths for Code 11	4-39
Code 11 Check Digit Verification	4-41
Transmit Code 11 Check Digits	4-42
Interleaved 2 of 5 (ITF)	4-43
Enable/Disable Interleaved 2 of 5	4-43
Set Lengths for Interleaved 2 of 5	4-43
I 2 of 5 Check Digit Verification	4-45
Transmit I 2 of 5 Check Digit	4-46
Convert I 2 of 5 to EAN-13	4-46
I 2 of 5 Security Level	4-47
Discrete 2 of 5 (DTF)	4-48
Enable/Disable Discrete 2 of 5	4-48
Set Lengths for Discrete 2 of 5	4-48
Codabar (NW - 7)	4-50
Enable/Disable Codabar	4-50
Set Lengths for Codabar	4-50
CLSI Editing	4-52
NOTIS Editing	4-52
Codabar Upper or Lower Case Start/Stop Characters Detection	4-53
MSI	4-54
Enable/Disable MSI	4-54
Set Lengths for MSI	4-54
MSI Check Digits	4-56
Transmit MSI Check Digit(s)	4-56
MSI Check Digit Algorithm	4-57
Chinese 2 of 5	4-58
Enable/Disable Chinese 2 of 5	4-58
Matrix 2 of 5	4-59
Enable/Disable Matrix 2 of 5	4-59
Set Lengths for Matrix 2 of 5	4-59
Matrix 2 of 5 Check Digit	4-61
Transmit Matrix 2 of 5 Check Digit	4-61
Korean 3 of 5	4-62
Enable/Disable Korean 3 of 5	4-62
Inverse 1D	4-63
GS1 DataBar	4-64
GS1 DataBar-14	4-64
GS1 DataBar Limited	4-64
GS1 DataBar Expanded	4-65
Convert GS1 DataBar to UPC/EAN	4-65
GS1 DataBar Limited Security Level	4-66

Composite	4-67
Composite CC-C	4-67
Composite CC-A/B	4-67
Composite TLC-39	4-68
UPC Composite Mode	4-68
GS1-128 Emulation Mode for UCC/EAN Composite Codes	4-69
Postal Codes	4-70
US Postnet	4-70
US Planet	4-70
Transmit US Postal Check Digit	4-71
UK Postal	4-71
Transmit UK Postal Check Digit	4-72
Japan Postal	4-72
Australia Post	4-73
Australia Post Format	4-74
Netherlands KIX Code	4-75
USPS 4CB/One Code/Intelligent Mail	4-75
UPU FICS Postal	4-76
2D Symbologies	4-77
Enable/Disable PDF417	4-77
Enable/Disable MicroPDF417	4-77
Code 128 Emulation	4-78
Data Matrix	4-79
Data Matrix Inverse	4-79
Decode Mirror Images (Data Matrix Only)	4-80
Maxicode	4-81
QR Code	4-81
QR Inverse	4-82
MicroQR	4-82
Aztec	4-83
Aztec Inverse	4-83
Han Xin	4-84
Han Xin Inverse	4-84
Symbology-Specific Security Levels	4-85
Redundancy Level	4-85
Bi-directional Redundancy	4-87
Security Level	4-88
Intercharacter Gap Size	4-89
Chapter 5: 123Scan2	
Introduction	5-1
Chapter 6: Advanced Data Formatting	
Introduction	6-1

Chapter 7: Maintenance and Technical Specifications

Introduction	7-1
Maintenance	7-1
Troubleshooting	7-2
Technical Specifications	7-3

Appendix A: Standard Default Parameters**Appendix B: Accessories**

Overview	B-1
Accessories Summary	B-2
Single-Slot CS4070 Charging Cradle with Spare Battery Charger	B-3
Battery Charging Indications	B-4
Bluetooth Connectivity	B-4
Eight-Slot CS4070 Charging Cradle	B-5
Battery Charging Indications	B-6
Bluetooth Connectivity	B-6
Eight-Slot Spare Battery Charger	B-7
Battery Charging Indications	B-8
LED Indications	B-8
Wall Mount Brackets	B-9
KT-102376-01R Bracket	B-9
KT-102375-01R Bracket	B-11
Bluetooth to USB HID Dongle	B-14
Pairing to a USB HID Device	B-15
Lanyard with Clip	B-16
Attaching and Removing the Lanyard	B-16

Appendix C: Bluetooth Connection Examples

Overview	C-1
iPad Pairing Example	C-2
Android Pairing Example	C-3
Accessing the Android Phone Keyboard	C-4
Windows 7 Pairing Example	C-5
Windows 8 Pairing Example	C-7
PIN Entry Bar Codes	C-9

Appendix D: Programming Reference

Code Type IDs	D-1
Symbol Code Identifiers	D-4
AIM Code Identifiers	D-6
GS1-128 (formerly UCC/EAN-128)	D-11
Setting Prefixes and Suffixes	D-12

Appendix E: Sample Bar Codes

UPC-A	E-1
UPC-E	E-1
UPC-E1	E-2
EAN-13	E-2
EAN-8	E-2
Code 39	E-2
Trioptic Code 39	E-3
Code 93	E-3
Code 11	E-3
Codabar	E-4
MSI	E-4
Interleaved 2 of 5	E-4
GS1 DataBar-14	E-5
PDF417	E-5
Data Matrix	E-5
Maxicode	E-5
QR Code	E-6
Han Xin	E-6
US Postnet	E-6
UK Postal	E-6

Appendix F: Numeric Bar Codes

Numeric Bar Codes	F-1
Cancel	F-3

Appendix G: ASCII Character Sets**Index**

ABOUT THIS GUIDE

Introduction

The *CS4070 Scanner Product Reference Guide* provides general instructions for setting up, operating, maintaining, and troubleshooting the scanner.

Configurations

The CS4070 scanner is available in the following configurations:

- CS4070SR - Standard range, cordless Bluetooth
- CS4070HC - Healthcare, cordless Bluetooth

Each scanner includes a micro USB host cable.

Accessories

See [Table B-1 on page B-2](#) for a list of accessories.

Chapter Descriptions

Topics covered in this guide are as follows:

- [Chapter 1, Getting Started](#) provides a product overview and describes how to charge, connect, and configure the scanner.
- [Chapter 2, Scanning](#) provides instructions for how to scan bar codes and send the data to a host, as well as beeper and LED definitions.
- [Chapter 3, User Preferences](#) describes each user preference feature and provides the programming bar codes for selecting these features for the scanner. It also includes wireless communication parameters and commonly used bar codes to customize how data is transmitted to the host device.
- [Chapter 4, Symbologies](#) describes all symbology features and provides the programming bar codes for selecting these features.
- [Chapter 5, 123Scan2](#) provides information on the PC-based scanner configuration tool 123Scan².
- [Chapter 6, Advanced Data Formatting](#) briefly describes ADF, a means of customizing data before transmission to the host device, and includes a reference to the *ADF Programmer Guide*.
- [Chapter 7, Maintenance and Technical Specifications](#) provides information on how to care for the scanner, troubleshooting, and technical specifications.
- [Appendix A, Standard Default Parameters](#) provides a table of all host devices and miscellaneous scanner defaults.
- [Appendix B, Accessories](#) provides information on CS4070 accessories, which provide a variety of product support capabilities.
- [Appendix C, Bluetooth Connection Examples](#) provides pairing examples for several host devices.
- [Appendix D, Programming Reference](#) provides a table of AIM code identifiers, ASCII character conversions, and keyboard maps.
- [Appendix E, Sample Bar Codes](#) includes sample bar codes.
- [Appendix F, Numeric Bar Codes](#) includes numeric bar codes for parameters requiring specific numeric values.
- [Appendix G, ASCII Character Sets](#) includes character set tables.

Notational Conventions

The following conventions are used in this document:

- *Italics* are used to highlight the following:
 - Chapters and sections in this and related documents
- **Bold** text is used to highlight the following:
 - Key names on a keypad
 - Button names on a screen or window.
- bullets (•) indicate:
 - Action items
 - Lists of alternatives
 - Lists of required steps that are not necessarily sequential
- Sequential lists (e.g., those that describe step-by-step procedures) appear as numbered lists.
- Throughout the programming bar code menus, asterisks (*) are used to denote default parameter settings.

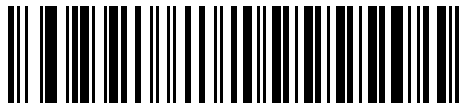

* Indicates Default — ***Baud Rate 9600** — Feature/Option



NOTE This symbol indicates something of special interest or importance to the reader. Failure to read the note will not result in physical harm to the reader, equipment or data.



CAUTION This symbol indicates that if this information is ignored, the possibility of data or material damage may occur.



WARNING! This symbol indicates that if this information is ignored the possibility that serious personal injury may occur.

Related Documents

- *CS4070 Scanner Quick Reference Guide* (p/n MN000763A01) provides general information to help the user get started with the scanner, including basic setup and operation instructions.

For the latest version of this guide and all guides, go to: <http://www.zebra.com/support>.

Service Information

If you have a problem using the equipment, contact your facility's technical or systems support. If there is a problem with the equipment, they will contact Global Customer Support at: <http://www.zebra.com/support>. When contacting support, please have the following information available:

- Serial number of the unit
- Model number or product name
- Software type and version number

Zebra responds to calls by e-mail, telephone or fax within the time limits set forth in service agreements.

If your problem cannot be solved by support, you may need to return your equipment for servicing and will be given specific directions. Zebra is not responsible for any damages incurred during shipment if the approved shipping container is not used. Shipping the units improperly can possibly void the warranty.

If you purchased your business product from a Zebra business partner, please contact that business partner for support.

CHAPTER 1 GETTING STARTED

Introduction

The CS4070 Scanner captures and stores bar codes for a variety of uses, and transmits bar code data to a host via USB connection or Bluetooth.

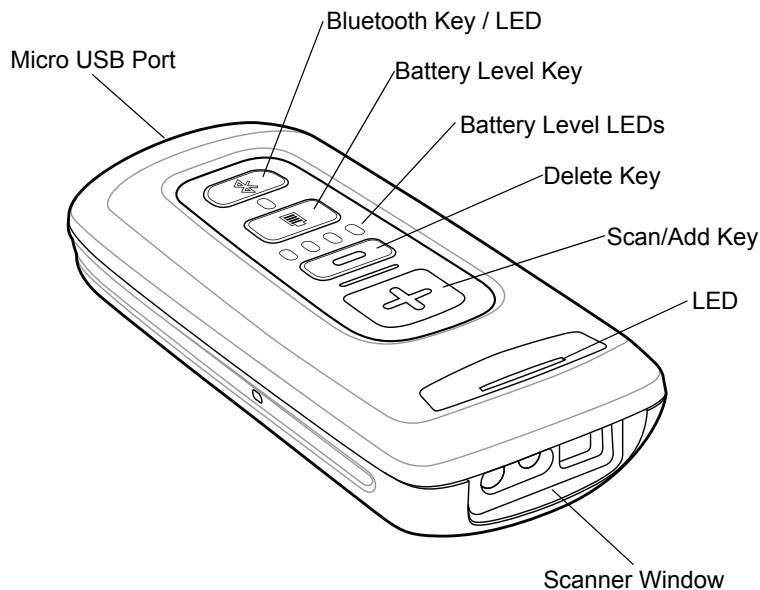

Figure 1-1 CS4070 Scanner

This scanner supports the following host interfaces:

- USB - The scanner connects to a USB host as a removable storage device, via a cradle or USB cable.
- Bluetooth - The scanner supports Bluetooth HID connection to a host (the default) where the scanner emulates a keyboard, as well as Serial Port Profile (SPP) connection where the scanner behaves as if there is a serial connection.

Unpacking the Scanner

Carefully remove all protective material from the scanner and save the shipping container for later storage and shipping. Verify that you received the following equipment:

- CS4070
- Lithium-ion battery
- Micro USB cable
- Quick Start Guide.

Inspect the equipment. If any equipment is missing or damaged, contact support. See [page xvi](#) for contact information.

Inserting and Removing the Battery

Inserting the Battery

Before using the scanner, insert the lithium-ion battery provided with the device.

1. Insert the battery, bottom first, into the battery compartment in the back of the device.
2. Press the battery down into the battery compartment until the battery release latch snaps into place.

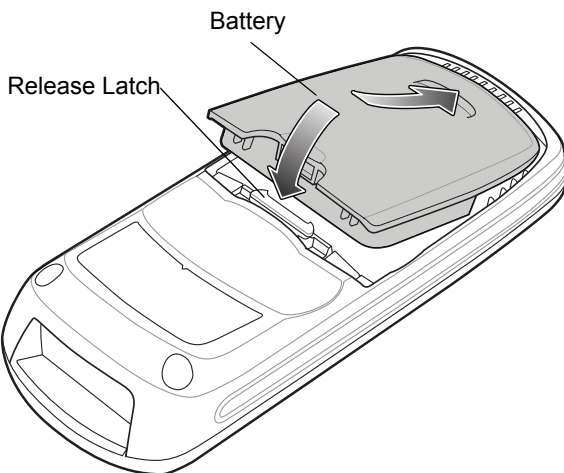

Figure 1-2 *Inserting the Battery*

- ✓ **NOTE** Position the battery correctly, with the battery charging contacts pointing towards the bottom of the scanner.

Removing the Battery

To remove the battery, pull the release latch upward with one finger, and use a finger from your other hand to pull back on the indent in the bottom of the battery housing. The battery rotates about the bottom edge and the latch end of the battery pops up, enabling you to lift it out from the sides.

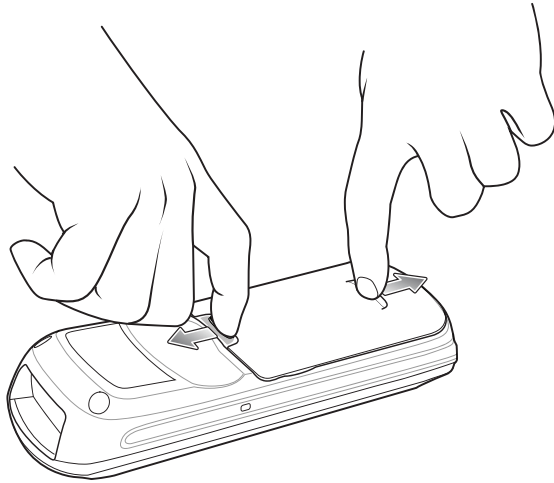

Figure 1-3 *Lift Release Latch*

Charging Batteries

Before using the CS4070 for the first time, charge the battery using the micro USB cable or a cradle until the green charge status LED lights. See [Table 2-1 on page 2-3](#) for charge status indications. For information about the charging accessories available for the device, see [Appendix B, Accessories](#).



NOTE If the battery is removed or replaced, the device cold boots. The internal back up battery retains the real-time clock.

Charging the Battery in a CS4070

Use one of the following methods to charge the battery when installed in a CS4070:

- Connect the micro USB cable to the micro USB port on the device, and the other end to a USB port on a host computer. Note that the scanner can not scan when connected to a host computer.
- Connect the micro USB cable to the micro USB port on the device, and the other end to a USB power adapter plugged into an AC outlet.
- Insert the CS4070 into a powered single-slot or 8-slot charging cradle. See [Single-Slot CS4070 Charging Cradle with Spare Battery Charger on page B-3](#) or [Eight-Slot CS4070 Charging Cradle on page B-5](#) for more information.

The CS4070 begins charging. The charge status LED flashes amber while charging, then turns solid green when fully charged. See [Table 2-1 on page 2-3](#) for charging indications.

Charging Spare Batteries

To charge a spare battery, insert the battery into a slot of a powered spare battery charging accessory with the charging contacts facing down, contacting the charging pins in the cradle. See [Single-Slot CS4070 Charging Cradle with Spare Battery Charger on page B-3](#) or [Eight-Slot Spare Battery Charger on page B-7](#).

The battery begins charging. The charge LED on the cradle lights to show the charge status.

Charging Temperature



IMPORTANT:

Charge batteries in temperatures from 0°C to 35°C (32°F to 95°F).

Note that at temperatures above 30°C the charging temperature is monitored and controlled by the device and the charging accessory. Charging is halted at temperatures above 35°C.

The device or accessory indicates when charging is disabled due to abnormal temperatures via its LED and/or battery icon. See [Table 2-1 on page 2-3](#), [Table B-2 on page B-4](#), and [Table B-3 on page B-8](#).

Connecting to the Host Computer

Batch Connection

The micro USB cable enables communication between the CS4070 and a PC, and charges the battery in the CS4070.

✓ **NOTE** To enter batch scanning mode, the scanner cannot be paired to a Bluetooth host.

To connect the CS4070 to a USB device:

1. Connect the USB A end of the USB cable to a USB port of the host or device.
2. Connect the micro USB connector of the cable to the CS4070.

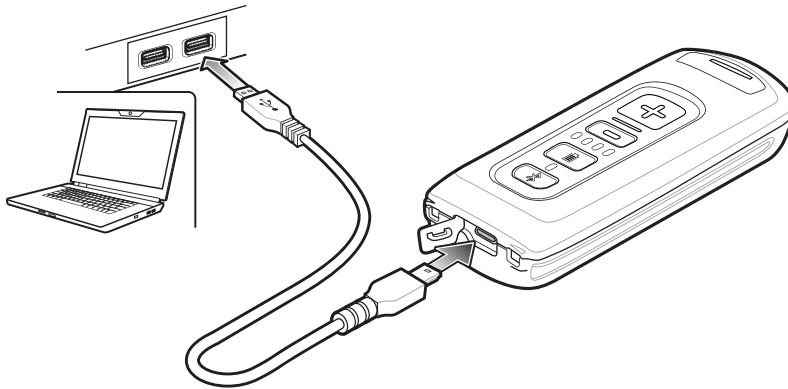

Figure 1-4 Micro USB Cable Communication

Bluetooth Connection: Development Options

✓ **NOTE** Multiple scanners can connect to a single host via SPP or HID. The host application must sort the data it receives from the scanner.

Serial Port Profile

This Bluetooth profile emulates a serial cable to provide a simply implemented wireless replacement for existing RS-232 based serial communications applications, including familiar control signals. It is the preferred communication profile implementation because accidental key strokes from the keyboard or touch screen on the host are not entered into the bar code data stream.

Human Interface Device Emulation

This Bluetooth profile is a lightweight wrapper of the Human Interface Device protocol defined for USB. Data transmitted from the Bluetooth scanner appears as keyboard entries to the Bluetooth host (Smartphone, PC, etc).

✓ **NOTE** Wedge data appears within whichever application has input focus.

Pairing

Pairing the CS4070 with a host device typically requires holding the Bluetooth button to place the scanner in discoverable mode, then scanning a pairing PIN if required. The CS4070 remembers the PIN for the last eight devices to which it paired, and can establish connection to these devices without customer input after the initial pairing.

- ✓ **NOTE** When using the dongle, simply scan the pairing bar code on the dongle to connect. No PIN is required. Note that the dongle allows a single connection only.

Supported Devices

The CS4070 supports connection to the following types of devices:

- iOS
- Android
- Windows 8 Pro
- Windows 7 Pro
- Windows XP (Microsoft, Broadcom, and other commonly available Bluetooth stacks)
- Windows RT
- Windows Embedded Compact (CE7)

To pair to a Bluetooth-enabled host:

1. Press the scan button (+) to wake the scanner.
2. Press and hold the Bluetooth button until the scanner beeps and the blue LED begins to flash to indicate that the scanner is discoverable by the host.
3. On the host, launch the Bluetooth pairing application and place the application into discover Bluetooth device mode.
4. Select the CS4070 from the discovered device list. The Bluetooth application may prompt you to scan a PIN it generated, or for you to create and then scan the PIN.
5. If required, scan [PIN Entry Bar Codes on page C-9](#) that correspond to the PIN, then scan Enter.

The Bluetooth button blinks slowly to indicate that the scanner paired with the host.

- ✓ **NOTE** Bluetooth pairing suspends temporarily while charging via a USB cable. Disconnecting the cable re-establishes Bluetooth pairing.

- ✓ **NOTE** When pairing with an iPad, press the delete key (-) on the CS4070 to toggle the virtual keyboard on and off.

For pairing examples, see [Appendix C, Bluetooth Connection Examples](#).

Unpairing

To temporarily unpair the scanner and host, press the Bluetooth button. This disables Bluetooth and the Bluetooth button stops blinking. Pressing the Bluetooth button again re-pairs the scanner with the host.

To permanently unpair the scanner and host, scan [Unpair on page 3-8](#). This allows the scanner to pair to a different host device.

✓ **NOTE** To enter batch scanning mode, the scanner cannot be paired to a Bluetooth host (applies to CS4070 model only).

Deleting the CS4070 from the Device List

To delete the device from the discovered devices list, tap and hold the device and select **Delete**.

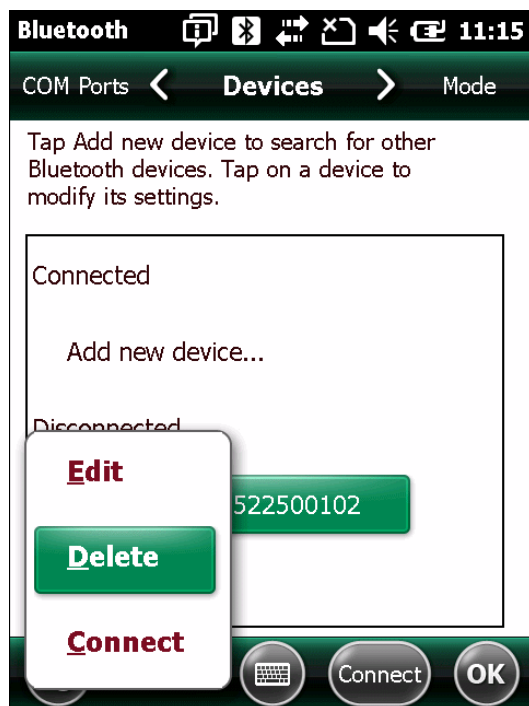

Figure 1-5 Deleting Device

Configuring the Scanner

123Scan2

To configure the scanner via 123Scan2, use this utility to generate a 2D bar code with the desired configuration options. Scan the bar code to configure the scanner with these options. Note that the CS4070 does not support 1D configuration bar codes. See [Chapter 5, 123Scan2](#).

Parameter Bar Codes and Config.ini

To configure the scanner:

1. Scan the parameter bar codes in [Chapter 3, User Preferences](#) and [Chapter 4, Symbologies](#) to customize scanner operation.
2. For additional customization, edit the **Config.ini** file on the scanner using the options in [Editing the Configuration File on page 1-9](#).
3. When deploying the new configuration to multiple scanners, to ensure unique CS4070 serial numbers appear in the host's discovery window, edit the **Config.ini** file to either remove the **BTName** entry or set it to blank ("BTName=") to ensure that each scanner uses the default BT name of **CS4070:<serial number>**.

Staging Multiple Scanners

After creating a **config.ini** file for one "golden" scanner with all desired settings, create a copy of the file from this scanner and copy it to other scanners via USB connection. Set the time and date on the "cloned" scanners by scanning bar codes from [Set Date and Time on page 3-5](#).



NOTE When deploying the new configuration to multiple scanners, to ensure unique CS4070 serial numbers appear in the host's discovery window, edit the **Config.ini** file to either remove the **BTName** entry or set it to blank ("BTName=") to ensure that each scanner uses the default BT name of **CS4070:<serial number>**.

Updating Scanner Firmware

To update scanner firmware:

1. Connect the micro USB cable from the host to the CS4070.
2. Copy the .dat and .bin files to the root directory of the scanner.
3. Disconnect the cable when the host indicates that it is safe to remove.

After several minutes the LED turns green to indicate that the firmware was successfully installed.

Editing the Configuration File

Use a text editor such as Notepad to set configuration values in the **Config.ini** editable text file in the **\Parameters** folder on the CS4070. [Table 1-1](#) lists the programmable contents of the file.

✓ **NOTE** If you make errors while editing the **Config.ini** file, the file LOG.TXT is created in the **\Parameters** folder. Consult this log file to determine the errors and make corrections.

Table 1-1 *Config.ini File Content*

Name	Description	Values	Default
AutoReconnect	Enable or disable automatic Bluetooth reconnection to dongle or another device	1 = Enabled 0 = Disabled	Disabled
BarcodeDB	Bar code database filename. If file exists, checks scanned bar codes against content. If bar code exists, generates a positive beep; if not a negative beep	String	DBASE.TXT
BarcodeFile	Name of file to store batched data	String	BARCODES.TXT
BTName	Bluetooth friendly name	String	CS4070
BTPin	Bluetooth PIN code	String	1234
BTProfile	Selected Bluetooth profile	0 = HID 1 = SPP 2 = SSI 3 = MFi_SPP 4 = MFi_SSI	HID
BtRfPower	Controls Bluetooth radio output power (100 m vs. 10 m)	0 = Class 1 1 = Class 2	Class 1
BTSleep	Time in seconds before device enters sleep mode while paired to another Bluetooth device if no activity is detected Note: Set this value equal to or less than the Sleep setting.	Word	14400 (4 hours)
ButtonBT	Enable or disable the Bluetooth button	1 = Enabled 0 = Disabled	Enabled
ButtonMinus	Enable or disable the delete (minus) button	1 = Enabled 0 = Disabled	Enabled
ButtonPlus	Enable or disable the scan/add (plus) button	1 = Enabled 0 = Disabled	Enabled
CodeID	Enable or disable saving CodeID in scanned bar codes file	1 = Enabled 0 = Disabled	Enabled
ConnectionInterval	Amount of time to try to establish connection/auto-reconnect	30 seconds 1 minute 5 minutes	30 seconds

Table 1-1 Config.ini File Content (Continued)

Name	Description	Values	Default
CountryKeyboardType	Country keyboard code	North_American Windows_Belgian_French Windows_French Windows_German Windows_Canadian Windows_Spanish Windows_Italian Windows_Swedish Windows_UK Windows_Japan Windows_Brazil	North_American
DateFormat	Date format	0= MM/DD/YY 1 = DD/MM/YY 2 = MM/DD/YYYY 3 = DD/MM/YYYY	MM/DD/YY
DisableProtectToggle	Enable or disable the scan bar code function	1 = Enabled 0 = Disabled	Disabled
HIDSecurity	Set HID security Notes: Some devices do not allow a connection in HID mode if this is set to low. Set security to low to connect to Android devices in HID mode without entering a PIN code.	2 = High (keyboard only - secure simple pairing capability) 3 = Low (no input/ no output - secure simple pairing capability)	High
KeystrokeDelay	For HID only, set the delay, in milliseconds, between emulated keystrokes Note: When pairing with the Android, set this to 70 ms to avoid data loss.	Word (0 to 100)	0
LEDBlue	Enable or disable the blue LED for normal operations and wake up	1 = Enabled 0 = Disabled	Enabled
LEDGreen	Enable or disable the green LED for normal operations and wake up	1 = Enabled 0 = Disabled	Enabled
LEDRed	Enable or disable the red LED for normal operations and wake up	1 = Enabled 0 = Disabled	Enabled
LEDAmber	Enable or disable the amber LED for normal operations and wake up	1 = Enabled 0 = Disabled	Enabled
Mute	Mute beeper	1 = Enabled 0 = Disabled	Off
PagerMotor (CS4070HC only)	Enable or disable the pager motor which vibrates the scanner for a period of time upon successful decode	1 = Enabled 0 = Disabled	Enabled
PagerMotorDuration (CS4070HC only)	Set the period of time for which the scanner vibrates	150 - 750 msec	200 msec
Prefix	Add prefix to decode data	Byte	<none>
ScanLED	Enable or disable the LEDs that illuminate while the laser scanner is active	1 = Enabled 0 = Disabled	Enabled

Table 1-1 *Config.ini File Content (Continued)*

Name	Description	Values	Default
ScanParam	Any scanner parameter. Multiple entries are allowed. Sent after reset or whenever scanner is powered. For example: ScanParam=0xf0,0x00,0x01 ScanParam=0xee,0x01 ScanParam=0x38,0x00	Variable	N/A
Separator	Separator character	Byte	';
Sleep	Time in seconds before device enters sleep mode if no activity is detected	Word	14400 (4 hours)
Suffix	Add suffix to decode data	Byte	<none>
TimeFormat	Time format for data stored in batch	1 = 12h 0 = 24h	24h
WakeUpBeep	Enable or disable wake up beep	1 = Enabled 0 = Disabled	Disabled
WakeUpLED	Enable or disable wake up LEDs	1 = Enabled 0 = Disabled	Disabled
ZeroOutHIDClassOfDevice	Some versions of Broadcom stack experience issues when connecting to HID devices. Enable this feature if this is the case.	1 = Enabled 0 = Disabled	Disabled

CHAPTER 2 SCANNING

Introduction

This chapter provides instructions for how to scan bar codes and send the data to a host. Beeper and LED definitions are also included.

Scanning

See [Chapter 1, Getting Started](#) to install and program the scanner. To scan:

1. Aim the scanner at the bar code.
2. Press the scan (+) button.

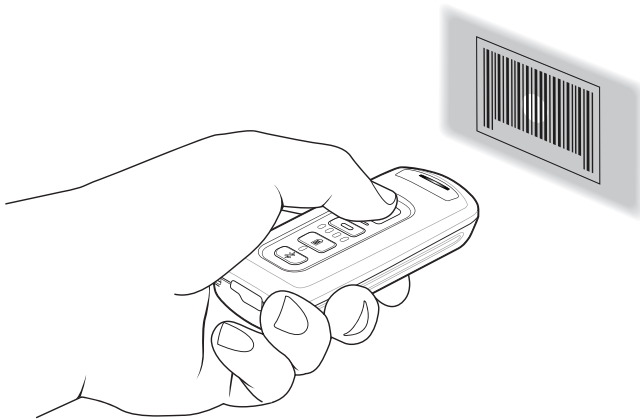

Figure 2-1 Scanning

3. Ensure the aiming dot is centered on the bar code.

The scanner beeps and the LED turns green to indicate a successful decode. See [Table 2-1](#) and [Table 2-2](#) for beeper and LED definitions..



NOTE The scanner cannot scan bar codes when it is connected to the host via the USB host cable.

- ✓ **NOTE** Hold down the + button for 10 seconds to toggle the beeper functionality on and off.

Deleting Bar Codes

In batch mode, to delete a bar code aim the scanner at the bar code and press the delete (-) button.

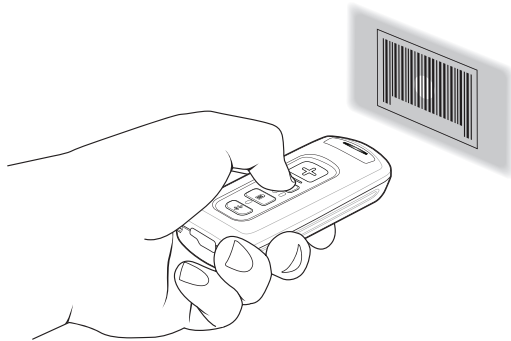

Figure 2-2 *Deleting a Bar Code in Batch Mode*

- ✓ **NOTE** Bar codes cannot be deleted in Bluetooth mode.

Transmitting Bar Code Data to Host

Transferring Data from a Batch Scanner

The BarcodeFile.txt file within the **Scanned Barcodes** directory on the scanner stores scanned bar code data. Connect the scanner to the host via USB cable and use Windows Explorer to navigate to the scanner. Copy the bar code data file to the host.

To clear the bar code data, delete the BarcodeFile.txt file from the scanner, or scan the **Clear Data** bar code on [page 3-9](#).

Autorun Feature

The scanner supports an autorun feature where you can build an autorun.inf file to automatically copy the data to the host upon connection. Autorun.inf is a text-based configuration file that defines, upon connecting the scanner, which executable or application to run on the host, which icon represents the scanner, and which menu commands appear when you right-click the scanner icon from Windows Explorer. For more information, search **autorun.inf** on any search engine.

Transferring Data from a Bluetooth Scanner

When the scanner is paired to a host via Bluetooth, data transmits to the host after each scan and is not stored on the device.

Out of Range Behavior

If the scanner moves out of range of the host, and does not re-pair with the host within the timeout period, scanned data is lost and the scanner emits a 3-beep error tone.

When the radio loses connection, the Bluetooth LED stops its slow, consistent blinking and the beeper emits a short high low beep. The Bluetooth LED blinks at a faster rate for a period of time while the device attempts to reestablish pairing with the host, and when it returns within range the device repairs. If repairing is unsuccessful the Bluetooth LED stops blinking.

To manually reestablish pairing when the device returns to range, press the Bluetooth LED button. Upon Bluetooth pairing, the beeper emits a short low high beep and the Bluetooth LED starts its slow, consistent blinking again.

User Interface Definitions

The scanner uses beeper and LED sequences to indicate various system events. [Table 2-1](#) and [Table 2-2](#) define these sequences and events.

LED Indications

Table 2-1 LED Indications

Function Performed	User Action	LED Feedback	Other
Scan attempt	Press scan (+) button	Flashing green	Imager on
Successful bar code scan		Solid green	Imager off
Battery charge status	Press battery charge button. If scanner is in sleep mode, press scan (+) button to wake it.	4 green	Full charge (12 hours in a busy environment)
		3 green	Approximately 3/4 charge
		2 green	Approximately 1/2 charge
		1 green	Approximately 1/4 charge
Delete bar code (when in batch mode)	Press & hold delete (-) button	Flashing amber	Imager on
Successful bar code deletion		Solid amber	Imager off
Unsuccessful deletion - item doesn't exist (when in batch mode)		Solid red	Imager off
Clear all bar code data (when delete (-) button enabled)	Hold delete (-) button 3 seconds past scan time	Flashing amber	Imager on

Table 2-1 LED Indications (Continued)

Function Performed	User Action	LED Feedback	Other
Successful clear all		Solid amber	Imager off
Charge scanner	Connect scanner to a host PC USB port	Flashing amber	Scanner connects in mass storage mode, auto-run application on PC launches
Charge complete		Solid green	
Toggle data protection on or off (when enabled)	Press & hold both scan (+) and delete (-) buttons for 6 seconds	None	
Successful data protection setting		Solid amber	
Enable Bluetooth radio	Hold Bluetooth button	Rapidly flashing blue LED	Bluetooth is enabled but has not paired with a host
Bluetooth radio pairing	Press Bluetooth button	Slowly flashing blue LED	
Bluetooth radio paired with host and in range		Very slowly flashing blue LED	
Bluetooth radio out of range of host		Blue LED is off	Stops transmitting beacons
Bluetooth radio returns to communication range of host	Press any button	Very slowly flashing blue LED	Re-pairs device with host
Special Conditions			
Memory low scan	Press & hold scan (+) button	Flashing red, then normal operation	
Delete/Clear All	Press & hold delete (-) button	Normal operation	
Memory Full Scan	Press & hold scan (+) button	Solid red	
Memory Full Delete/Clear All	Press & hold delete (-) button	Normal operation	
Data protection (enabled and on)	Scan/function/host com	Rapidly flashing red	
Unexpected failure	Scan/function/dock	Flashing red, green and amber for 5 seconds	Contact support
Battery depleted	Scan/function/dock	None	

Beeper Indications

Table 2-2 *Beeper Indications*

Function Performed	Beeper Feedback	Other
Successful bar code scan	Short high beep	Imager off
Successful bar code deletion	Short medium beep	Imager off
Unsuccessful deletion - item doesn't exist (when in batch mode)	Long short short beep	Imager off
Successful clear all	2 long medium beeps	Imager off
Successful data protection setting	Short long short beep	
Connect scanner to a host PC USB port to charge scanner	Low high beep	
Enable Bluetooth radio	Short beep	Hold Bluetooth button
Bluetooth radio pairing	Short low high beep	
Bluetooth radio out of range of host	Short high low beep	Stops transmitting beacons
Bluetooth radio returns to communication range of host	Short low high beep	Re-pairs device with host
Bluetooth automatic reconnect to host or disconnect from host	2 short beeps	<i>Auto-reconnect on page 3-10</i> must be enabled
Attempt to scan when out of Bluetooth radio range	4 high beeps	No Bluetooth transmission
Memory Full Scan	Long beep for 5 seconds or until scan button released	

CHAPTER 3 USER PREFERENCES

Introduction

This chapter describes each user preference feature and provides the programming bar codes for selecting these features for the scanner.

The scanner ships with the settings shown in the [User Preferences Default Table on page 3-2](#) (also see [Appendix A, Standard Default Parameters](#) for all host device and miscellaneous scanner defaults). If the default values suit the requirements, programming is not necessary. To change these values, scan a single bar code or a short bar code sequence. After scanning [on page 3-25](#), the new settings are stored in non-volatile memory and are preserved when the scanner powers down.

To return all features to their default values, scan the [Reset Factory Defaults](#) bar code on [page 3-4](#). Throughout the programming bar code menus, default values are indicated with asterisks (*).



Scanning Sequence Examples

In most cases, scan only one bar code to set a parameter value. For example, to set the beeper tone to high, scan the **High Frequency** (beeper tone) bar code under [Beeper Tone on page 3-15](#). The scanner issues a fast warble beep and the LED turns green, indicating a successful parameter entry.

Other parameters, such as **Data Transmission Formats**, require scanning several bar codes. See the parameter description for this procedure.

Errors While Scanning

Unless otherwise specified, if an error is made during a scanning sequence, re-scan the correct parameter.

User Preferences Default Parameters

Table 3-1 lists the defaults for user preference parameters. To change any option, scan the appropriate bar code(s) provided in this chapter.

✓ **NOTE** See *Appendix A, Standard Default Parameters* for all default parameters.

Table 3-1 *User Preferences Default Table*

Parameter	Parameter Number	Factory Default	Page Number
Reset Factory Defaults	N/A	N/A	3-4
Set Date	N/A	N/A	3-5
Set Time	N/A	N/A	3-5
Cancel Date and Time Settings	N/A	N/A	3-5
Bluetooth Options			
Pairing Bar Code Format	N/A	N/A	3-7
Bluetooth Unpair	N/A	N/A	3-8
Bluetooth Profile	N/A	HID	3-8
Clear Data	N/A	N/A	3-9
Auto-reconnect	N/A	Disable	3-10
Connection Interval	N/A	30 seconds	3-11
HID Security	911	High	3-11
Radio Output Power	N/A	Class 1	3-12
Set HID CoD to Zero	N/A	Disable	3-12
User Preferences			
Beeper Volume	140	High	3-14
Beeper Tone	145	Medium Frequency	3-15
Mute Beeper	N/A	Do Not Mute	3-15
Decode Pager Motor (CS4070HC only)	613	Enable	3-16
Decode Pager Motor Duration (CS4070HC only)	626	200 msec	3-16
Picklist Mode	402	Disabled Always	3-18
Fuzzy 1D Processing	514	Enable	3-18
Mirrored Image	624	Disable	3-19
Mobile Phone/Display Mode	716	Disable	3-19
PDF Prioritization	719	Disable	3-20

Table 3-1 *User Preferences Default Table (Continued)*

Parameter	Parameter Number	Factory Default	Page Number
PDF Prioritization Timeout	720	200 ms	3-20
Data Options			
Transmit Code ID Character	45	None	3-21
Prefix Value	99, 105	7013 <CR><LF>	3-22
Suffix 1 Value Suffix 2 Value	98, 104 100, 106	7013 <CR><LF>	3-22
Transmit "No Read" Message	94	Disable	3-24
Scan Data Transmission Format	235	Data as is	3-23
Version Options			
Send Firmware Version	N/A	N/A	3-25
Send Scan Engine Version	N/A	N/A	3-25
Send Dongle Version	N/A	N/A	3-25

Reset Factory Defaults

To reset the scanner to factory defaults, scan the following bar code. This rebuilds the configuration file from program memory.



Reset Factory Defaults

Set Date and Time

- ✓ **NOTE** You must scan the configuration bar codes to set the time and date stamp on the scanner. The time and date can not be set or edited in the **config.ini** file. This setting persists for three months if the scanner is not used.

Set Date

Scan the **Set Date** bar code, then scan six numeric digits in the format **mmddy** from [Numeric Bar Codes for Date and Time Settings on page 3-6](#) (first two for the month, second two for the day, third two for the year).

- ✓ **NOTE** To change the date format from **mmddy**, see [DateFormat on page 1-10](#).

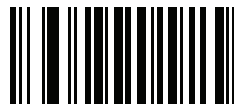

Set Date

Set Time

Scan the **Set Time** bar code, then scan four numeric digits in the format **hhmm** from [Numeric Bar Codes for Date and Time Settings on page 3-6](#) representing the time according to the 24 hour clock (first two for the hour, second two for the minute).

For example, to set the time to 8:45 in the morning, scan the following bar code, then scan 0, 8, 4, 5. To set the time to 3:07 in the afternoon, scan 1, 5, 0, 7.

- ✓ **NOTE** To change the time format between **12h** and **24h**, see [TimeFormat on page 1-11](#).

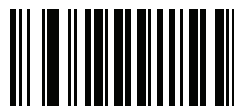

Set Time

Cancel Date and Time Setting

Scan the **Cancel Set Date/Time** bar code to cancel the date and time settings.

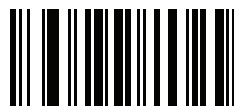

Cancel Set Date/Time

Numeric Bar Codes for Date and Time Settings



0



2



4



6



8



Enter



1



3



5



7



9

Bluetooth Options

Master/Slave Set Up

The scanner can be set up as a master or slave. When the scanner is set up as a slave, it is discoverable and connectable to other devices. When the scanner is set up as a master, the Bluetooth address of the remote device to which a connection is requested is required.

Slave

When the scanner is set up as a slave device, the scanner accepts an incoming connection request from a remote device.

✓ **NOTE** The number of scanners is dependent on the host's capability.

Setting the scanner up as a slave typically requires holding the Bluetooth button to place the scanner in discoverable mode, then scanning a pairing PIN. See [Appendix C, Bluetooth Connection Examples](#) for more information.

Master

When the scanner is set up as a master, it initiates the radio connection to a slave device. Initiate the connection in one of two ways:

- Scan the bar code on the dongle. See [Bluetooth to USB HID Dongle on page B-14](#).
- Create and scan a pairing bar code with the remote device address. See [Pairing Bar Code Format](#).

Pairing Bar Code Format

When connecting the scanner as a master to a remote Bluetooth device, you must create a pairing bar code for the device. The Bluetooth address of the remote device must be known. Pairing bar codes are Code 128 bar codes and are formatted as follows:

<Fnc 3>Bxxxxxxxxxxx

where:

- **B** (or **LNKB**) is the prefix
- xxxxxxxxxxxx represents the 12-character Bluetooth address.

For example, if the remote device to which the scanner can connect has a Bluetooth address of 11:22:33:44:55:66, then the pairing bar code is:



Pairing Bar Code Content:
'B' + Bluetooth Address

B112233445566

Bluetooth Unpair

Scan the following bar code to unpair the scanner from the host.



Unpair

Bluetooth Profile

Scan a bar code below to select a Bluetooth profile:

- **Bluetooth HID Profile** - the scanner emulates a keyboard.
- **Bluetooth Serial Port Profile (SPP)** - the scanner emulates a serial connection.
- **Bluetooth SSI Profile** - the scanner uses SSI.
- **Bluetooth MFi SPP** - allows the scanner to connect to a serial port on iOS devices such as iPad and iPhone.
- **Bluetooth MFi SSI** - allows bi-directional (command and control) communication between the CS4070 and iOS devices.

Bluetooth Profile (continued)



***Bluetooth HID Profile**



Bluetooth SPP

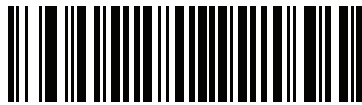

Bluetooth SSI Profile

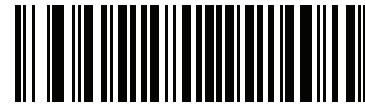

Bluetooth MFi_SPP



Bluetooth MFi_SSI

Clear Data

Scan the following bar code to clear all batch bar code data on the scanner. This deletes the BarcodeFile.txt from the scanner.



Clear Data

Auto-reconnect

When auto-reconnect is enabled, the scanner automatically tries to reconnect to a remote device when a disconnection occurs that is due to the radio losing communication. This can happen if the scanner goes out of range with the remote device, or if the remote device powers down. The scanner tries to reconnect for the period of time specified by the [Connection Interval on page 3-11](#). During that time the blue LED continues to blink.

If the auto-reconnect process fails due to page time-outs, the scanner sounds a timeout beep (long low/long high) and turns off the radio. To re-start the auto-reconnect process press the scan '+' or delete '-' key.

If the auto-reconnect process fails because the remote device rejects the connection attempt, the scanner sounds a connection reject beep sequence and deletes the remote pairing address. If this happens, you must scan a pairing bar code to attempt a new connection to the remote device.

- ✓ **NOTE** If you scan a bar code during the auto-reconnect sequence, the scanner emits a transmission error beep sequence and does not transmit the data to the host. Normal scanning operation resumes after re-establishing the connection. For error beep sequence definitions, see [Table 2-2 on page 2-5](#).

Scan a bar code below to enable or disable automatic Bluetooth reconnection to the dongle or another device.



Enable Auto-reconnect



***Disable Auto-reconnect**

Connection Interval

Select the time period that the scanner attempts to connect or auto-reconnect to another device.



***30 Seconds**



1 Minute

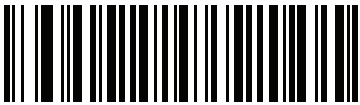

5 Minutes

HID Security

Parameter # 911

Scan one of the following bar codes to set HID security as follows:

- High - keyboard only, secure simple pairing capability (select this for iOS devices)
- Low - no input/no output, secure simple pairing capability (select this for Android devices)

✓ **NOTE** Some devices do not allow a connection in HID mode if this is set to low.
Set security to low to connect to Android devices in HID mode without entering a PIN code

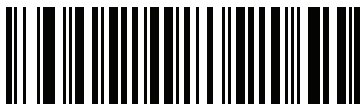

***HID Security High
(2)**



**HID Security Low
(3)**

Radio Output Power

The CS4070 uses a Class 1 Bluetooth radio with a transmission range of up to 100m. To place the radio in a Class 2 operating mode to restrict the transmission range to 10m and reduce the effect of the radio on neighboring wireless systems, scan the **Bluetooth Class 2** bar code.



***Bluetooth Class 1**



Bluetooth Class 2

Set HID CoD to Zero

Some versions of Broadcom stack experience issues when connecting to HID devices. If experiencing issues, delete the CS4070 device from the Broadcom stack, enable [ZeroOutHIDClassOfDevice on page 1-11](#) or scan the **Set HID CoD to Zero** bar code below, and reconnect.



***Use HID CoD**



Set HID CoD to Zero

User Preference Settings

Parameter Bar Code Scanning

Parameter # 236

To disable the decoding of parameter bar codes, including the **Set Defaults** parameter bar codes, scan the **Disable Parameter Scanning** bar code below. To enable decoding of parameter bar codes, scan **Enable Parameter Scanning**.



***Enable Parameter Bar Code Scanning**
(1)



Disable Parameter Bar Code Scanning
(0)

Beep After Good Decode

Parameter # 56

Scan a bar code below to select whether or not the scanner beeps after a good decode. If selecting **Do Not Beep After Good Decode**, the beeper still operates during parameter menu scanning and to indicate error conditions.



***Beep After Good Decode (Enable)**
(1)

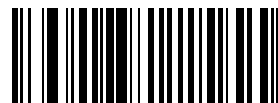

Do Not Beep After Good Decode (Disable)
(0)

Beeper Volume

Parameter # 140

To select a decode beep volume, scan the appropriate bar code.



Low Volume
(2)



Medium Volume
(1)



***High Volume**
(0)

Beeper Tone

Parameter # 145

To select a decode beep frequency (tone), scan the appropriate bar code.

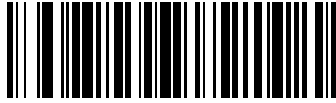

Low Frequency
(2)

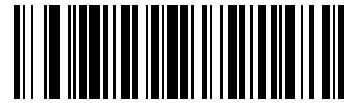

*Medium Frequency
(1)

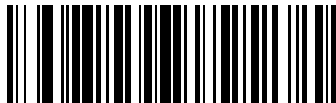

High Frequency
(0)

Mute Beeper

Scan the **Mute Beeper** bar code to mute the beeper.



Mute Beeper
(1)



*Do Not Mute Beeper
(0)

Decode Pager Motor (CS4070HC only)

Parameter # 613

The scanner includes a pager motor which, when enabled, vibrates the scanner for a period of time when a successful decode occurs.

Scan a bar code below to enable or disable the pager motor. If enabled, scan the appropriate bar code to set the period of time in which to vibrate the scanner (see [Decode Pager Motor Duration \(CS4070HC only\)](#) below).

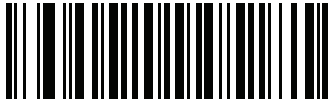

Pager Motor Disable
(0)

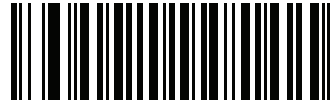

*Pager Motor Enable
(1)

Decode Pager Motor Duration (CS4070HC only)

Parameter # 626

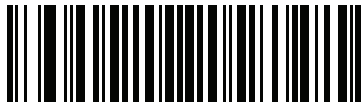

150 msec
(15)



*200 msec
(20)

Decode Pager Motor Duration (continued)



250 msec
(25)

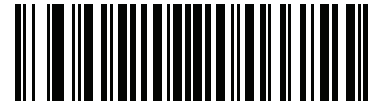

300 msec
(30)

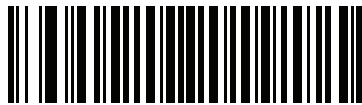

400 msec
(40)



500 msec
(50)



600 msec
(60)



750 msec
(75)

Picklist Mode

Parameter # 402

Picklist mode enables the scanner to decode only bar codes aligned under the center of the aiming pattern. Select one of the following picklist modes:

- **Disabled Always** - Picklist mode is always disabled.
- **Enabled Always** - Picklist mode is always enabled.



***Disabled Always**
(0)



Enabled Always
(2)

Fuzzy 1D Processing

Parameter # 514

This option is enabled by default to optimize decode performance on 1D bar codes, including damaged and poor quality symbols. Disable this only if you experience time delays when decoding 2D bar codes, or in detecting a no decode.



***Enable Fuzzy 1D Processing**
(1)



Disable Fuzzy 1D Processing
(0)

Mirrored Image

Parameter # 624

Enable this to scan images in reverse, or mirrored, as if seen through a mirror. This mode is useful in applications requiring scanning through a mirror and using symbologies that do not decode in reverse.



***Disable Mirrored Image
(0)**



**Enable Mirrored Image
(1)**

Mobile Phone/Display Mode

Parameter # 716

This mode improves bar code reading performance with target bar codes displayed on mobile phones and electronic displays.



***Disable Mobile Phone/Display Mode
(0)**

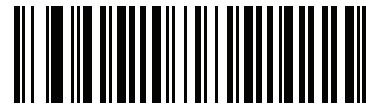

**Enable Mobile Phone/Display Mode
(3)**

PDF Prioritization

Parameter # 719

Enable this feature to delay decoding a 1D bar code (Code 128 of 8 to 25 characters length) by the value specified in [PDF Prioritization Timeout](#). During that time the scanner attempts to decode a PDF417 symbol (e.g., on a US driver's license), and if successful reports this only. If it does not decode (can not find) a PDF417 symbol, it reports the 1D symbol after the timeout. The 1D symbol must be in the device's field of view for the scanner to report it. This parameter does not affect decoding other symbologies.



*Disable PDF Prioritization
(0)



Enable PDF Prioritization
(1)

PDF Prioritization Timeout

Parameter # 720

When [PDF Prioritization](#) is enabled, this timeout specifies how long the scanner attempts to decode a PDF417 symbol before reporting the 1D bar code in the field of view.

Scan the following bar code, then scan four digits from [Appendix F, Numeric Bar Codes](#) that specify the timeout in milliseconds. For example, to enter 400 ms, scan the following bar code, then scan 0400. The range is 0 to 5000 ms, and the default is 200 ms.



PDF Prioritization Timeout

Data Options

Transmit Code ID Character

Parameter # 45

A Code ID character identifies the code type of a scanned bar code. This is useful when decoding more than one code type. In addition to any single character prefix already selected, the Code ID character is inserted between the prefix and the decoded symbol.

Select no Code ID character, a Symbol Code ID character, or an AIM Code ID character. For Code ID Characters, see [Appendix D, Programming Reference](#).

✓ **NOTE** If you enable Symbol Code ID Character or AIM Code ID Character, and enable [Transmit "No Read" Message on page 3-24](#), the scanner appends the code ID for Code 39 to the NR message.

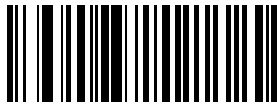

Symbol Code ID Character
(2)



AIM Code ID Character
(1)



*None
(0)

Prefix/Suffix Values

Key Category Parameter # P = 99, S1 = 98, S2 = 100

Decimal Value Parameter # P = 105, S1 = 104, S2 = 106

You can append a prefix and/or one or two suffixes to scan data for use in data editing. To set a value for a prefix or suffix, scan a four-digit number (i.e., four bar codes from [Appendix F, Numeric Bar Codes](#)) that corresponds to that value. See [Appendix G, ASCII Character Sets](#) for the four-digit codes.

When using host commands to set the prefix or suffix, set the key category parameter to 1, then set the 3-digit decimal value. See [Appendix G, ASCII Character Sets](#) for the four-digit codes.

To correct an error or change a selection, scan [Cancel on page F-3](#).

✓ **NOTE** To use Prefix/Suffix values, first set the [Scan Data Transmission Format on page 3-23](#).

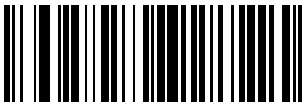

**Scan Prefix
(7)**

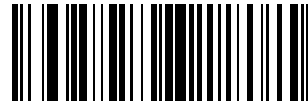

**Scan Suffix 1
(6)**



**Scan Suffix 2
(8)**



Data Format Cancel

Scan Data Transmission Format

Parameter # 235

To change the scan data format, scan one of the following eight bar codes corresponding to the desired format.

✓ **NOTE** If using this parameter do not use ADF rules to set the prefix/suffix.

✓ **NOTE** To append a carriage return to data, scan the **<data><suffix1>** bar code.

If [Bluetooth Profile on page 3-8](#) is set to **BT SPP** and you select **<data><suffix1>**, then set **Suffix=0x0A** in the **Config.ini** file to enable linefeed to move the cursor to the next line in a text file.

To set values for the prefix and/or suffix, see [Prefix/Suffix Values on page 3-22](#).



***Data As Is**
(0)



<DATA> <SUFFIX 1>
(1)



<DATA> <SUFFIX 2>
(2)



<DATA> <SUFFIX 1> <SUFFIX 2>
(3)



<PREFIX> <DATA >
(4)

Scan Data Transmission Format (continued)

<PREFIX> <DATA> <SUFFIX 1>
(5)



<PREFIX> <DATA> <SUFFIX 2>
(6)



<PREFIX> <DATA> <SUFFIX 1> <SUFFIX 2>
(7)

Transmit “No Read” Message**Parameter # 94**

Scan a bar code below to select whether or not to transmit a No Read message. Enable this to transmit the characters NR when a successful decode does not occur before trigger release or during the timeout period. Disable this to send nothing to the host if a symbol does not decode.



NOTE If you enable **Transmit No Read**, and also enable Symbol Code ID Character or AIM Code ID Character for [Transmit Code ID Character on page 3-21](#), the scanner appends the code ID for Code 39 to the NR message.



Enable No Read
(1)



*Disable No Read
(0)

Send Versions

Firmware Version

Scan the following bar code to send the firmware version to the host.



Firmware Version

Scan Engine Version

Scan the following bar code to send the scan engine version to the host.



Scan Engine Version

Dongle Version

Scan the following bar code to send the dongle version to the host.



Dongle Version

CHAPTER 4 SYMBOLOGIES

Introduction

This chapter describes symbology features and provides the programming bar codes for selecting these features for the scanner. Before programming, follow the instructions in [Chapter 1, Getting Started](#).

The scanner ships with the settings in [Table 4-1 on page 4-2](#) (also see [Appendix A, Standard Default Parameters](#) for all scanner defaults). If the default values suit requirements, programming is not necessary. Set a feature value by scanning a single bar code or a short bar code sequences.

✓ **NOTE** Most computer monitors allow scanning the bar codes directly on the screen. When scanning from the screen, be sure to set the document magnification to a level where the bar code can be seen clearly, and bars and/or spaces are not merging.

To return all features to default values, see [Reset Factory Defaults on page 3-4](#). Throughout the programming bar code menus, asterisks (*) indicate default values.



* Indicates Default — *Enable UPC-A — Feature/Option
(1) — Option Value

Scanning Sequence Examples

In most cases, scan only one bar code to set a parameter value. For example, to transmit bar code data without the UPC-A check digit, scan the **Do Not Transmit UPC-A Check Digit** bar code under [Transmit UPC-A Check Digit on page 4-17](#). The scanner issues a fast warble beep and the LED turns green, indicating a successful parameter entry.

Other parameters, such as **Set Length(s) for D 2 of 5** require scanning several bar codes in sequence. See the parameter description for this procedure.

Errors While Scanning

Unless otherwise specified, to correct an error during a scanning sequence, re-scan the correct parameter.

Symbology Default Parameters

[Table 4-1](#) lists the defaults for all symbologies parameters. To change any option, scan the appropriate bar code(s) in this chapter.

✓ **NOTE** See [Appendix A, Standard Default Parameters](#) for all default parameters.

Table 4-1 Symbology Parameter Defaults

Parameter	Parameter Number	Default	Page Number
Enable/Disable All Code Types			4-7
1D Symbologies			
UPC/EAN			
UPC-A	1	Enable	4-8
UPC-E	2	Enable	4-8
UPC-E1	12	Disable	4-9
EAN-8/JAN 8	4	Enable	4-9
EAN-13/JAN 13	3	Enable	4-10
Bookland EAN	83	Disable	4-10
Bookland ISBN Format	576	ISBN-10	4-11
Decode UPC/EAN/JAN Supplementals (2 and 5 digits)	16	Ignore	4-13
User-Programmable Supplementals		000	4-15
Supplemental 1:	579		
Supplemental 2:	580		
UPC/EAN/JAN Supplemental Redundancy	80	10	4-15
Decode UPC/EAN/JAN Supplemental AIM ID	672	Combined	4-16
Transmit UPC-A Check Digit	40	Enable	4-17
Transmit UPC-E Check Digit	41	Enable	4-17
Transmit UPC-E1 Check Digit	42	Enable	4-18
UPC-A Preamble	34	System Character	4-19
UPC-E Preamble	35	System Character	4-19

Table 4-1 Symbology Parameter Defaults (Continued)

Parameter	Parameter Number	Default	Page Number
UPC-E1 Preamble	36	System Character	4-21
Convert UPC-E to A	37	Disable	4-22
Convert UPC-E1 to A	38	Disable	4-22
EAN-8/JAN-8 Extend	39	Disable	4-23
UCC Coupon Extended Code	85	Disable	4-23
Coupon Report	730	New Coupon Format	4-24
ISSN EAN	617	Disable	4-24
Code 128			
Code 128	8	Enable	4-25
Set Length(s) for Code 128	209, 210	1 to 55	4-25
GS1-128 (formerly UCC/EAN-128)	14	Enable	4-27
ISBT 128	84	Enable	4-27
ISBT Concatenation	577	Autodiscriminate	4-28
Check ISBT Table	578	Enable	4-29
ISBT Concatenation Redundancy	223	10	4-29
Code 128 Security Level	751	Security Level 1	4-30
Code 39			
Code 39	0	Enable	4-31
Trioptic Code 39	13	Disable	4-31
Convert Code 39 to Code 32 (Italian Pharmacy Code)	86	Disable	4-32
Code 32 Prefix	231	Disable	4-32
Set Length(s) for Code 39	18, 19	1 to 55	4-33
Code 39 Check Digit Verification	48	Disable	4-34
Transmit Code 39 Check Digit	43	Disable	4-34
Code 39 Full ASCII Conversion	17	Disable	4-35
Code 39 Security Level	750	Security Level 1	4-36
Code 93			
Code 93	9	Enable	4-37
Set Length(s) for Code 93	26, 27	1 to 55	4-37

Table 4-1 Symbology Parameter Defaults (Continued)

Parameter	Parameter Number	Default	Page Number
Code 11			
Code 11	10	Disable	4-39
Set Lengths for Code 11	28, 29	4 to 55	4-39
Code 11 Check Digit Verification	52	Disable	4-41
Transmit Code 11 Check Digit(s)	47	Disable	4-42
Interleaved 2 of 5 (ITF)			
Interleaved 2 of 5 (ITF)	6	Enable	4-43
Set Lengths for I 2 of 5	22, 23	6 to 55	4-43
I 2 of 5 Check Digit Verification	49	Disable	4-45
Transmit I 2 of 5 Check Digit	44	Disable	4-46
Convert I 2 of 5 to EAN 13	82	Disable	4-46
I 2 of 5 Security Level	1121	Security Level 1	4-47
Discrete 2 of 5 (DTF)			
Discrete 2 of 5	5	Disable	4-48
Set Length(s) for D 2 of 5	20, 21	1 to 55	4-48
Codabar (NW - 7)			
Codabar	7	Enable	4-50
Set Lengths for Codabar	24, 25	4 to 55	4-50
CLSI Editing	54	Disable	4-52
NOTIS Editing	55	Disable	4-52
Codabar Upper or Lower Case Start/Stop Characters Detection	855	Upper Case	
MSI			
MSI	11	Disable	4-54
Set Length(s) for MSI	30, 31	4 to 55	4-54
MSI Check Digits	50	One	4-56
Transmit MSI Check Digit	46	Disable	4-56
MSI Check Digit Algorithm	51	Mod 10/Mod 10	4-57
Chinese 2 of 5			
Chinese 2 of 5	408	Disable	4-58

Table 4-1 Symbology Parameter Defaults (Continued)

Parameter	Parameter Number	Default	Page Number
Matrix 2 of 5			
Matrix 2 of 5	618	Disable	4-59
Matrix 2 of 5 Lengths	619, 620	4 to 55	4-59
Matrix 2 of 5 Check Digit	622	Disable	4-61
Transmit Matrix 2 of 5 Check Digit	623	Disable	4-61
Korean 3 of 5			
Korean 3 of 5	581	Disable	4-62
Inverse 1D	586	Regular	4-62
GS1 DataBar			
GS1 DataBar-14	338	Enable	4-64
GS1 DataBar Limited	339	Enable	4-64
GS1 DataBar Expanded	340	Enable	4-65
Convert GS1 DataBar to UPC/EAN	397	Disable	4-65
GS1 DataBar Limited Security Level	728	Level 3	4-66
Composite			
Composite CC-C	341	Disable	4-67
Composite CC-A/B	342	Disable	4-67
Composite TLC-39	371	Disable	4-68
UPC Composite Mode	344	Never Linked	4-68
GS1-128 Emulation Mode for UCC/EAN Composite Codes	427	Disable	4-69
Postal Codes			
US Postnet	89	Disable	4-70
US Planet	90	Disable	4-70
Transmit US Postal Check Digit	95	Enable	4-71
UK Postal	91	Disable	4-71
Transmit UK Postal Check Digit	96	Enable	4-72
Japan Postal	290	Disable	4-72
Australia Post	291	Disable	4-73
Australia Post Format	718	Autodiscriminate	4-74
Netherlands KIX Code	326	Disable	4-75

Table 4-1 Symbology Parameter Defaults (Continued)

Parameter	Parameter Number	Default	Page Number
USPS 4CB/One Code/Intelligent Mail	592	Disable	4-75
UPU FICS Postal	611	Disable	4-76
2D Symbologies			
PDF417	15	Enable	4-77
MicroPDF417	227	Disable	4-77
Code 128 Emulation	123	Disable	4-78
Data Matrix	292	Enable	4-79
Data Matrix Inverse	588	Inverse Autodetect	4-79
Decode Mirror Images (Data Matrix Only)	537	Auto	4-80
Maxicode	294	Disable	4-81
QR Code	293	Enable	4-81
QR Inverse	587	Regular	4-82
MicroQR	573	Enable	4-82
Aztec	574	Enable	4-83
Aztec Inverse	589	Inverse Autodetect	4-83
Han Xin	1167	Disable	4-84
Han Xin Inverse	1168	Regular	4-84
Symbology-Specific Security Levels			
Redundancy Level	78	1	4-85
Bi-directional Redundancy	67	Disable	4-87
Security Level	77	1	4-88
Intercharacter Gap Size	381	Normal	4-89

Enable/Disable All Code Types

To disable all symbologies, scan **Disable All Code Types** below. This is useful when enabling only a few code types.

Scan **Enable All Code Types** turn on (enable) all code types. This is useful when you want to read all codes, or when you want to disable only a few code types.



Disable All Code Types



Enable All Code Types

UPC/EAN

Enable/Disable UPC-A

Parameter # 1

To enable or disable UPC-A, scan the appropriate bar code below.

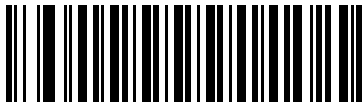

***Enable UPC-A
(1)**

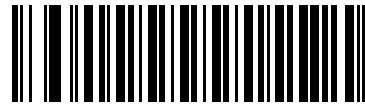

**Disable UPC-A
(0)**

Enable/Disable UPC-E

Parameter # 2

To enable or disable UPC-E, scan the appropriate bar code below.

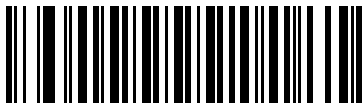

***Enable UPC-E
(1)**



**Disable UPC-E
(0)**

Enable/Disable UPC-E1

Parameter # 12

UPC-E1 is disabled by default.

To enable or disable UPC-E1, scan the appropriate bar code below.

✓ **NOTE** UPC-E1 is not a UCC (Uniform Code Council) approved symbology.

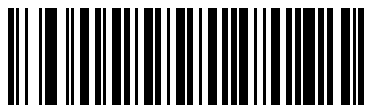

**Enable UPC-E1
(1)**

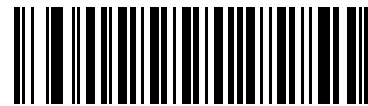

***Disable UPC-E1
(0)**

Enable/Disable EAN-8/JAN-8

Parameter # 4

To enable or disable EAN-8/JAN-8, scan the appropriate bar code below.

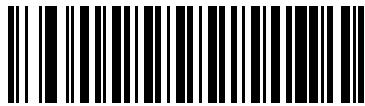

***Enable EAN-8/JAN-8
(1)**

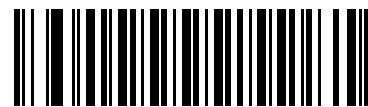

**Disable EAN-8/JAN-8
(0)**

Enable/Disable EAN-13/JAN-13

Parameter # 3

To enable or disable EAN-13/JAN-13, scan the appropriate bar code below.

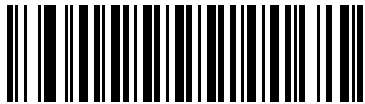

***Enable EAN-13/JAN-13**
(1)



Disable EAN-13/JAN-13
(0)

Enable/Disable Bookland EAN

Parameter # 83

To enable or disable Bookland EAN, scan the appropriate bar code below.

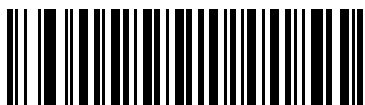

Enable Bookland EAN
(1)



***Disable Bookland EAN**
(0)



NOTE If you enable Bookland EAN, select a [Bookland ISBN Format on page 4-11](#). Also select either Decode UPC/EAN Supplementals, Autodiscriminate UPC/EAN Supplementals, or Enable 978/979 Supplemental Mode in [Decode UPC/EAN/JAN Supplementals on page 4-12](#).

Bookland ISBN Format

Parameter # 576

If you enabled Bookland EAN using [Enable/Disable Bookland EAN on page 4-10](#), select one of the following formats for Bookland data:

- **Bookland ISBN-10** - The scanner reports Bookland data starting with 978 in traditional 10-digit format with the special Bookland check digit for backward-compatibility. Data starting with 979 is not considered Bookland in this mode.
- **Bookland ISBN-13** - The scanner reports Bookland data (starting with either 978 or 979) as EAN-13 in 13-digit format to meet the 2007 ISBN-13 protocol.



*Bookland ISBN-10
(0)



Bookland ISBN-13
(1)



NOTE For Bookland EAN to function properly, first enable Bookland EAN using [Enable/Disable Bookland EAN on page 4-10](#), then select either Decode UPC/EAN Supplementals, Autodiscriminate UPC/EAN Supplementals, or Enable 978/979 Supplemental Mode in [Decode UPC/EAN/JAN Supplementals on page 4-12](#).

Decode UPC/EAN/JAN Supplementals

Parameter # 16

Supplementals are bar codes appended according to specific format conventions (e.g., UPC A+2, UPC E+2, EAN 13+2). The following options are available:

- If you select **Ignore UPC/EAN with Supplementals**, and the scanner is presented with a UPC/EAN plus supplemental symbol, the scanner decodes UPC/EAN and ignores the supplemental characters.
- If you select **Decode UPC/EAN with Supplementals**, the scanner only decodes UPC/EAN symbols with supplemental characters, and ignores symbols without supplementals.
- If you select **Autodiscriminate UPC/EAN Supplementals**, the scanner decodes UPC/EAN symbols with supplemental characters immediately. If the symbol does not have a supplemental, the scanner must decode the bar code the number of times set via [UPC/EAN/JAN Supplemental Redundancy on page 4-15](#) before transmitting its data to confirm that there is no supplemental.
- If you select one of the following **Supplemental Mode** options, the scanner immediately transmits EAN-13 bar codes starting with that prefix that have supplemental characters. If the symbol does not have a supplemental, the scanner must decode the bar code the number of times set via [UPC/EAN/JAN Supplemental Redundancy on page 4-15](#) before transmitting its data to confirm that there is no supplemental. The scanner transmits UPC/EAN bar codes that do not have that prefix immediately.
 - **Enable 378/379 Supplemental Mode**
 - **Enable 978/979 Supplemental Mode**



NOTE If you select 978/979 Supplemental Mode and are scanning Bookland EAN bar codes, see [Enable/Disable Bookland EAN on page 4-10](#) to enable Bookland EAN, and select a format using [Bookland ISBN Format on page 4-11](#).

- **Enable 977 Supplemental Mode**
- **Enable 414/419/434/439 Supplemental Mode**
- **Enable 491 Supplemental Mode**
- **Enable Smart Supplemental Mode** - applies to EAN-13 bar codes starting with any prefix listed previously.
- **Supplemental User-Programmable Type 1** - applies to EAN-13 bar codes starting with a 3-digit user-defined prefix. Set this 3-digit prefix using [User-Programmable Supplementals on page 4-15](#).
- **Supplemental User-Programmable Type 1 and 2** - applies to EAN-13 bar codes starting with either of two 3-digit user-defined prefixes. Set the 3-digit prefixes using [User-Programmable Supplementals on page 4-15](#).
- **Smart Supplemental Plus User-Programmable 1** - applies to EAN-13 bar codes starting with any prefix listed previously or the user-defined prefix set using [User-Programmable Supplementals on page 4-15](#).
- **Smart Supplemental Plus User-Programmable 1 and 2** - applies to EAN-13 bar codes starting with any prefix listed previously or one of the two user-defined prefixes set using [User-Programmable Supplementals on page 4-15](#).

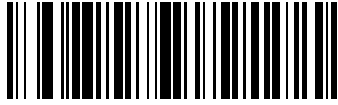

NOTE To minimize the risk of invalid data transmission, select either to decode or ignore supplemental characters.

Decode UPC/EAN/JAN Supplementals (continued)

**Decode UPC/EAN/JAN Only With Supplementals
(1)**



***Ignore Supplementals
(0)**

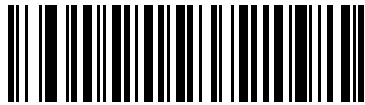

**Autodiscriminate UPC/EAN/JAN Supplementals
(2)**



**Enable 378/379 Supplemental Mode
(4)**



**Enable 978/979 Supplemental Mode
(5)**



**Enable 977 Supplemental Mode
(7)**

Decode UPC/EAN/JAN Supplementals (continued)



Enable 414/419/434/439 Supplemental Mode
(6)



Enable 491 Supplemental Mode
(8)



Enable Smart Supplemental Mode
(3)



Supplemental User-Programmable Type 1
(9)



Supplemental User-Programmable Type 1 and 2
(10)



Smart Supplemental Plus User-Programmable 1
(11)



Smart Supplemental Plus User-Programmable 1 and 2
(12)

User-Programmable Supplementals

Supplemental 1: Parameter # 579

Supplemental 2: Parameter # 580

If you selected a Supplemental User-Programmable option from [Decode UPC/EAN/JAN Supplementals on page 4-12](#), select **User-Programmable Supplemental 1** to set the 3-digit prefix. Then select the 3 digits using the numeric bar codes beginning on [page F-1](#). Select **User-Programmable Supplemental 2** to set a second 3-digit prefix. Then select the 3 digits using the numeric bar codes beginning on [page F-1](#). The default is 000 (zeroes).



User-Programmable Supplemental 1



User-Programmable Supplemental 2

UPC/EAN/JAN Supplemental Redundancy

Parameter # 80

If you selected **Autodiscriminate UPC/EAN/JAN Supplementals**, this option adjusts the number of times to decode a symbol without supplementals before transmission. The range is from two to thirty times. Five or above is recommended when decoding a mix of UPC/EAN/JAN symbols with and without supplementals. The default is 10.

Scan the bar code below to set a decode redundancy value. Next, scan two numeric bar codes in [Appendix F, Numeric Bar Codes](#). Enter a leading zero for single digit numbers. To correct an error or change a selection, scan [Cancel on page F-3](#).

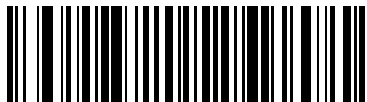

UPC/EAN/JAN Supplemental Redundancy

UPC/EAN/JAN Supplemental AIM ID Format

Parameter # 672

Select an output format when reporting UPC/EAN/JAN bar codes with Supplementals with *Transmit Code ID Character* on page 3-21 set to **AIM Code ID Character**:

- **Separate** - transmit UPC/EAN with supplementals with separate AIM IDs but one transmission, i.e.:
]E<0 or 4><data>]E<1 or 2>[supplemental data]
- **Combined** – transmit UPC/EAN with supplementals with one AIM ID and one transmission, i.e.:
]E3<data+supplemental data>
- **Separate Transmissions** - transmit UPC/EAN with supplementals with separate AIM IDs and separate transmissions, i.e.:
]E<0 or 4><data>
]E<1 or 2>[supplemental data]



Separate
(0)



***Combined**
(1)



Separate Transmissions
(2)

Transmit UPC-A Check Digit

Parameter # 40

The check digit is the last character of the symbol used to verify the integrity of the data. Scan the appropriate bar code below to transmit the bar code data with or without the UPC-A check digit. It is always verified to guarantee the integrity of the data.

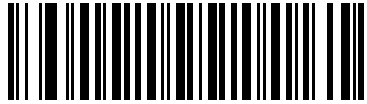

***Transmit UPC-A Check Digit
(1)**

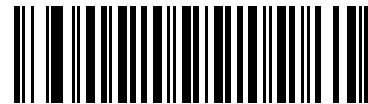

**Do Not Transmit UPC-A Check Digit
(0)**

Transmit UPC-E Check Digit

Parameter # 41

The check digit is the last character of the symbol used to verify the integrity of the data. Scan the appropriate bar code below to transmit the bar code data with or without the UPC-E check digit. It is always verified to guarantee the integrity of the data.

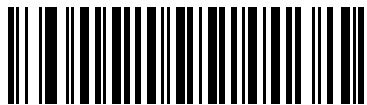

***Transmit UPC-E Check Digit
(1)**

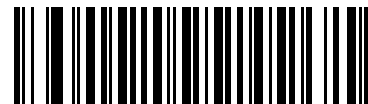

**Do Not Transmit UPC-E Check Digit
(0)**

Transmit UPC-E1 Check Digit

Parameter # 42

The check digit is the last character of the symbol used to verify the integrity of the data. Scan the appropriate bar code below to transmit the bar code data with or without the UPC-E1 check digit. It is always verified to guarantee the integrity of the data.

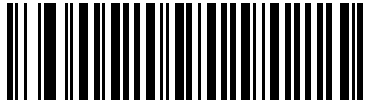

***Transmit UPC-E1 Check Digit
(1)**

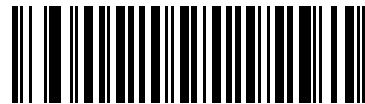

**Do Not Transmit UPC-E1 Check Digit
(0)**

UPC-A Preamble

Parameter # 34

Preamble characters are part of the UPC symbol, and include Country Code and System Character. There are three options for transmitting a UPC-A preamble to the host device: transmit System Character only, transmit System Character and Country Code ("0" for USA), and transmit no preamble. Select the appropriate option to match the host system.

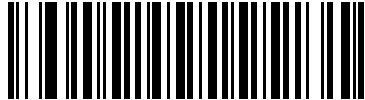

No Preamble (<DATA>)
(0)

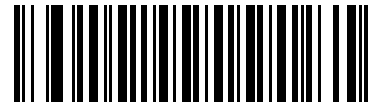

***System Character (<SYSTEM CHARACTER>
<DATA>)**
(1)

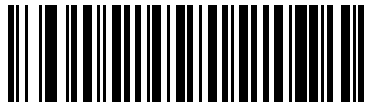

**System Character & Country Code
(< COUNTRY CODE> <SYSTEM CHARACTER>
<DATA>)**
(2)

UPC-E Preamble

Parameter # 35

Preamble characters are part of the UPC symbol, and include Country Code and System Character. There are three options for transmitting a UPC-E preamble to the host device: transmit System Character only, transmit System Character and Country Code ("0" for USA), and transmit no preamble. Select the appropriate option to match the host system.

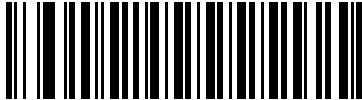

No Preamble (<DATA>)
(0)

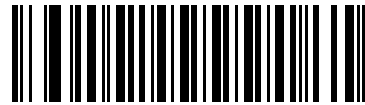

***System Character (<SYSTEM CHARACTER> <DATA>)**
(1)

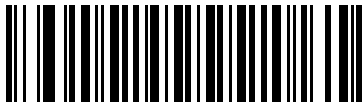

System Character & Country Code
(< COUNTRY CODE> <SYSTEM CHARACTER>
<DATA>)
(2)

UPC-E1 Preamble

Parameter # 36

Preamble characters are part of the UPC symbol, and include Country Code and System Character. There are three options for transmitting a UPC-E1 preamble to the host device: transmit System Character only, transmit System Character and Country Code ("0" for USA), and transmit no preamble. Select the appropriate option to match the host system.

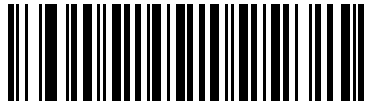

No Preamble (<DATA>)
(0)



***System Character (<SYSTEM CHARACTER> <DATA>)**
(1)

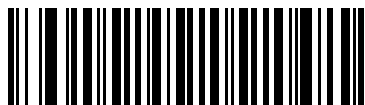

System Character & Country Code
(< COUNTRY CODE> <SYSTEM CHARACTER> <DATA>)
(2)

Convert UPC-E to UPC-A

Parameter # 37

Enable this to convert UPC-E (zero suppressed) decoded data to UPC-A format before transmission. After conversion, the data follows UPC-A format and is affected by UPC-A programming selections (e.g., Preamble, Check Digit).

Disable this to transmit UPC-E decoded data as UPC-E data, without conversion.

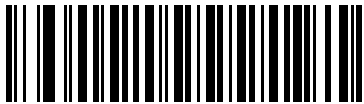

Convert UPC-E to UPC-A (Enable)
(1)

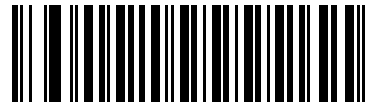

*Do Not Convert UPC-E to UPC-A (Disable)
(0)

Convert UPC-E1 to UPC-A

Parameter # 38

Enable this to convert UPC-E1 decoded data to UPC-A format before transmission. After conversion, the data follows UPC-A format and is affected by UPC-A programming selections (e.g., Preamble, Check Digit).

Disable this to transmit UPC-E1 decoded data as UPC-E1 data, without conversion.

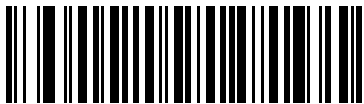

Convert UPC-E1 to UPC-A (Enable)
(1)



*Do Not Convert UPC-E1 to UPC-A (Disable)
(0)

EAN-8/JAN-8 Extend

Parameter # 39

Enable this parameter to add five leading zeros to decoded EAN-8 symbols to make them compatible in format to EAN-13 symbols. Disable this to transmit EAN-8 symbols as is.

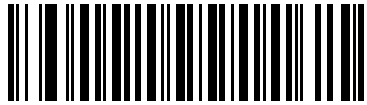

Enable EAN/JAN Zero Extend
(1)

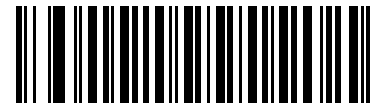

*Disable EAN/JAN Zero Extend
(0)

UCC Coupon Extended Code

Parameter # 85

Enable this parameter to decode UPC-A bar codes starting with digit '5', EAN-13 bar codes starting with digit '99', and UPC-A/GS1-128 Coupon Codes. UPCA, EAN-13, and GS1-128 must be enabled to scan all types of Coupon Codes.

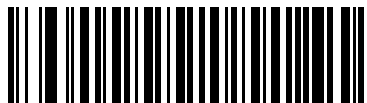

Enable UCC Coupon Extended Code
(1)



*Disable UCC Coupon Extended Code
(0)



NOTE See [UPC/EAN/JAN Supplemental Redundancy on page 4-15](#) to control autodiscrimination of the GS1-128 (right half) of a coupon code.

Coupon Report

Parameter # 730

Select an option to determine which type of coupon format to support.

- Select **Old Coupon Format** to support UPC-A/GS1-128 and EAN-13/GS1-128.
- Select **New Coupon Format** as an interim format to support UPC-A/GS1-DataBar and EAN-13/GS1-DataBar.
- If you select **Autodiscriminate Format**, the scanner supports both **Old Coupon Format** and **New Coupon Format**.



Old Coupon Format
(0)



***New Coupon Format**
(1)



Autodiscriminate Coupon Format
(2)

ISSN EAN

Parameter # 617

To enable or disable ISSN EAN, scan the appropriate bar code below.



Enable ISSN EAN
(1)



***Disable ISSN EAN**
(0)

Code 128

Enable/Disable Code 128

Parameter # 8

To enable or disable Code 128, scan the appropriate bar code below.

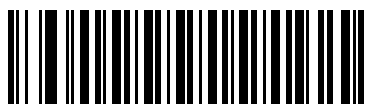

*Enable Code 128
(1)



Disable Code 128
(0)

Set Lengths for Code 128

Parameter # 209, 210

The length of a code refers to the number of characters (i.e., human readable characters), including check digit(s) the code contains. Set lengths for Code 128 to any length, one or two discrete lengths, or lengths within a specific range. The default is 1 to 55.

✓ **NOTE** When setting lengths for different bar code types, enter a leading zero for single digit numbers.

- **One Discrete Length** - Select this option to decode only Code 128 symbols containing a selected length. Select the length using the numeric bar codes in [Appendix F, Numeric Bar Codes](#). For example, to decode only Code 128 symbols with 14 characters, scan **Code 128 - One Discrete Length**, then scan **1** followed by **4**. To correct an error or change the selection, scan [Cancel on page F-3](#).
- **Two Discrete Lengths** - Select this option to decode only Code 128 symbols containing either of two selected lengths. Select lengths using the numeric bar codes in [Appendix F, Numeric Bar Codes](#). For example, to decode only Code 128 symbols containing either 2 or 14 characters, select **Code 128 - Two Discrete Lengths**, then scan **0, 2, 1**, and then **4**. To correct an error or change the selection, scan [Cancel on page F-3](#).
- **Length Within Range** - Select this option to decode a Code 128 symbol with a specific length range. Select lengths using numeric bar codes in [Appendix F, Numeric Bar Codes](#). For example, to decode Code 128 symbols containing between 4 and 12 characters, first scan **Code 128 - Length Within Range**. Then scan **0, 4, 1**, and **2** (enter a leading zero for single digit numbers). To correct an error or change the selection, scan [Cancel on page F-3](#).
- **Any Length** - Select this option to decode Code 128 symbols containing any number of characters within the scanner's capability.

Set Lengths for Code 128 (continued)

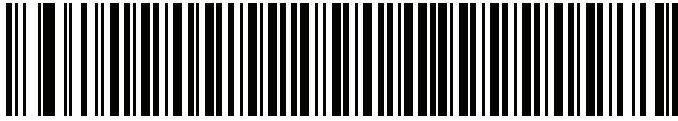

Code 128 - One Discrete Length

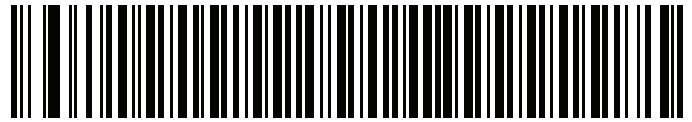

Code 128 - Two Discrete Lengths

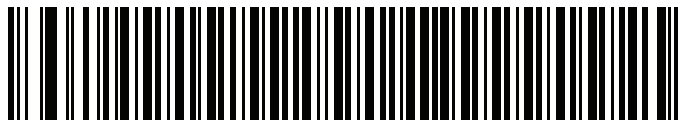

Code 128 - Length Within Range

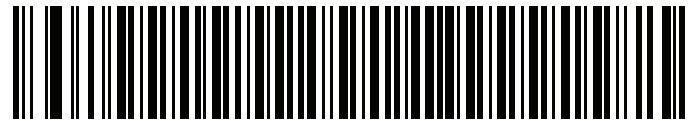

Code 128 - Any Length

Enable/Disable GS1-128 (formerly UCC/EAN-128)

Parameter # 14

To enable or disable GS1-128, scan the appropriate bar code below.

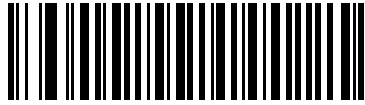

***Enable GS1-128
(1)**

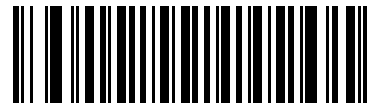

**Disable GS1-128
(0)**

Enable/Disable ISBT 128

Parameter # 84

ISBT 128 is a variant of Code 128 used in the blood bank industry. Scan a bar code below to enable or disable ISBT 128. If necessary, the host must perform concatenation of the ISBT data.



***Enable ISBT 128
(1)**



**Disable ISBT 128
(0)**

ISBT Concatenation

Parameter # 577

Select an option for concatenating pairs of ISBT code types:

- If you select **Disable ISBT Concatenation**, the scanner does not concatenate pairs of ISBT codes it encounters.
- If you select **Enable ISBT Concatenation**, there must be two ISBT codes in order for the scanner to decode and perform concatenation. The scanner does not decode single ISBT symbols.
- If you select **Autodiscriminate ISBT Concatenation**, the scanner decodes and concatenates pairs of ISBT codes immediately. If only a single ISBT symbol is present, the scanner must decode the symbol the number of times set via [ISBT Concatenation Redundancy on page 4-29](#) before transmitting its data to confirm that there is no additional ISBT symbol.



Disable ISBT Concatenation
(0)

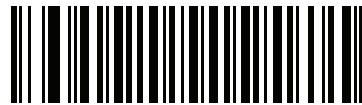

Enable ISBT Concatenation
(1)

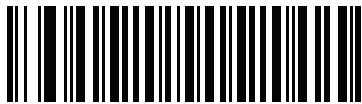

***Autodiscriminate ISBT Concatenation**
(2)

Check ISBT Table

Parameter # 578

The ISBT specification includes a table that lists several types of ISBT bar codes that are commonly used in pairs. If you set **ISBT Concatenation** to **Enable**, enable **Check ISBT Table** to concatenate only those pairs found in this table. Other types of ISBT codes are not concatenated.



*Enable Check ISBT Table
(1)



Disable Check ISBT Table
(0)

ISBT Concatenation Redundancy

Parameter # 223

If you set **ISBT Concatenation** to **Autodiscriminate**, use this parameter to set the number of times the scanner must decode an ISBT symbol before determining that there is no additional symbol.

Scan the bar code below, then scan two numeric bar codes in [Appendix F, Numeric Bar Codes](#) to set a value between 2 and 20. Enter a leading zero for single digit numbers. To correct an error or change a selection, scan [Cancel on page F-3](#). The default is 10.



ISBT Concatenation Redundancy

Code 128 Security Level

Parameter # 751

Code 128 bar codes are vulnerable to misdecodes, particularly when Code 128 Lengths is set to **Any Length**. The scanner offers four levels of decode security for Code 128 bar codes. There is an inverse relationship between security and scanner aggressiveness. Increasing the level of security can reduce scanning aggressiveness, so select only the level of security necessary.

- **Code 128 Security Level 0:** This setting allows the scanner to operate in its most aggressive state, while providing sufficient security in decoding most in-spec bar codes.
- **Code 128 Security Level 1:** A bar code must be successfully read twice, and satisfy certain safety requirements before being decoded. This default setting eliminates most misdecodes.
- **Code 128 Security Level 2:** Select this option with greater bar code security requirements if **Security Level 1** fails to eliminate misdecodes.
- **Code 128 Security Level 3:** If you selected **Security Level 2**, and misdecodes still occur, select this security level to apply the highest safety requirements. A bar code must be successfully read three times before being decoded.

✓ **NOTE** Selecting this option is an extreme measure against mis-decoding severely out-of-spec bar codes. Selecting this level of security significantly impairs the decoding ability of the scanner. If this level of security is required, try to improve the quality of the bar codes.

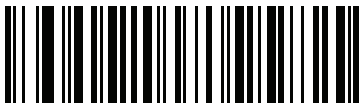

Code 128 Security Level 0
(0)



*Code 128 Security Level 1
(1)

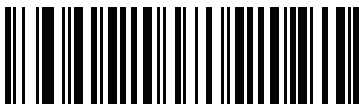

Code 128 Security Level 2
(2)



Code 128 Security Level 3
(3)

Code 39

Enable/Disable Code 39

Parameter # 0

To enable or disable Code 39, scan the appropriate bar code below.

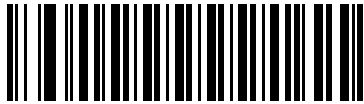

***Enable Code 39**
(1)

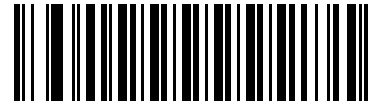

Disable Code 39
(0)

Enable/Disable Trioptic Code 39

Parameter # 13

Trioptic Code 39 is a variant of Code 39 used in the marking of computer tape cartridges. Trioptic Code 39 symbols always contain six characters. To enable or disable Trioptic Code 39, scan the appropriate bar code below.

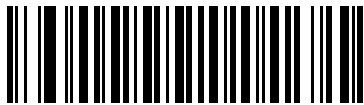

Enable Trioptic Code 39
(1)



***Disable Trioptic Code 39**
(0)



NOTE You cannot enable Trioptic Code 39 and Code 39 Full ASCII simultaneously.

Convert Code 39 to Code 32

Parameter # 86

Code 32 is a variant of Code 39 used by the Italian pharmaceutical industry. Scan the appropriate bar code below to enable or disable converting Code 39 to Code 32.

✓ **NOTE** Code 39 must be enabled for this parameter to function.

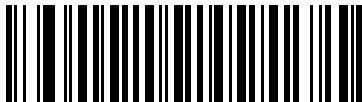

Enable Convert Code 39 to Code 32
(1)

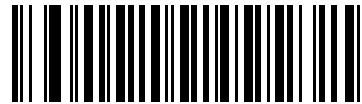

***Disable Convert Code 39 to Code 32**
(0)

Code 32 Prefix

Parameter # 231

Scan the appropriate bar code below to enable or disable adding the prefix character "A" to all Code 32 bar codes.

✓ **NOTE** Convert Code 39 to Code 32 must be enabled for this parameter to function.

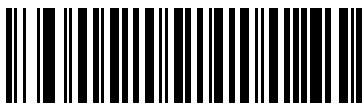

Enable Code 32 Prefix
(1)

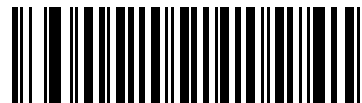

***Disable Code 32 Prefix**
(0)

Set Lengths for Code 39

Parameter # 18, 19

The length of a code refers to the number of characters (i.e., human readable characters), including check digit(s) the code contains. Set lengths for Code 39 to any length, one or two discrete lengths, or lengths within a specific range. If Code 39 Full ASCII is enabled, **Length Within a Range** or **Any Length** are the preferred options. The default is 1 to 55.

✓ **NOTE** When setting lengths for different bar code types, enter a leading zero for single digit numbers.

- **One Discrete Length** - Select this option to decode only Code 39 symbols containing a selected length. Select the length using the numeric bar codes in [Appendix F, Numeric Bar Codes](#). For example, to decode only Code 39 symbols with 14 characters, scan **Code 39 - One Discrete Length**, then scan **1** followed by **4**. To correct an error or change the selection, scan [Cancel on page F-3](#).
- **Two Discrete Lengths** - Select this option to decode only Code 39 symbols containing either of two selected lengths. Select lengths using the numeric bar codes in [Appendix F, Numeric Bar Codes](#). For example, to decode only Code 39 symbols containing either 2 or 14 characters, select **Code 39 - Two Discrete Lengths**, then scan **0, 2, 1**, and then **4**. To correct an error or change the selection, scan [Cancel on page F-3](#).
- **Length Within Range** - Select this option to decode a Code 39 symbol with a specific length range. Select lengths using numeric bar codes in [Appendix F, Numeric Bar Codes](#). For example, to decode Code 39 symbols containing between 4 and 12 characters, first scan **Code 39 - Length Within Range**. Then scan **0, 4, 1**, and **2** (enter a leading zero for single digit numbers). To correct an error or change the selection, scan [Cancel on page F-3](#).
- **Any Length** - Select this option to decode Code 39 symbols containing any number of characters within the scanner's capability.



Code 39 - One Discrete Length



Code 39 - Two Discrete Lengths



Code 39 - Length Within Range



Code 39 - Any Length

Code 39 Check Digit Verification

Parameter # 48

Enable this feature to check the integrity of all Code 39 symbols to verify that the data complies with specified check digit algorithm. Only Code 39 symbols which include a modulo 43 check digit are decoded. Enable this feature if the Code 39 symbols contain a Modulo 43 check digit.

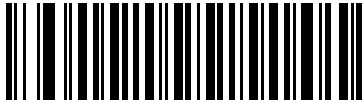

Enable Code 39 Check Digit
(1)

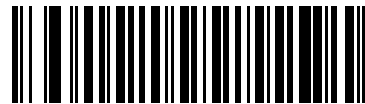

*Disable Code 39 Check Digit
(0)

Transmit Code 39 Check Digit

Parameter # 43

Scan a bar code below to transmit Code 39 data with or without the check digit.



Transmit Code 39 Check Digit (Enable)
(1)

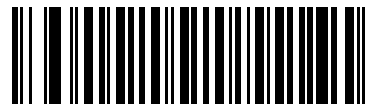

*Do Not Transmit Code 39 Check Digit (Disable)
(0)



NOTE Code 39 Check Digit Verification must be enabled for this parameter to function.

Code 39 Full ASCII Conversion

Parameter # 17

Code 39 Full ASCII is a variant of Code 39 which pairs characters to encode the full ASCII character set. To enable or disable Code 39 Full ASCII, scan the appropriate bar code below.



Enable Code 39 Full ASCII
(1)

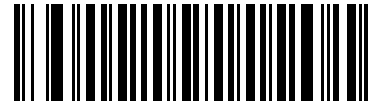

***Disable Code 39 Full ASCII**
(0)



NOTE You cannot enable Trioptic Code 39 and Code 39 Full ASCII simultaneously.

Code 39 Security Level

Parameter # 750

The scanner offers four levels of decode security for Code 39 bar codes. There is an inverse relationship between security and scanner aggressiveness. Increasing the level of security can reduce scanning aggressiveness, so select only the level of security necessary.

- **Code 39 Security Level 0:** This setting allows the scanner to operate in its most aggressive state, while providing sufficient security in decoding most in-spec bar codes.
- **Code 39 Security Level 1:** This default setting eliminates most misdecodes.
- **Code 39 Security Level 2:** Select this option with greater bar code security requirements if **Security Level 1** fails to eliminate misdecodes.
- **Code 39 Level 3:** If you selected **Security Level 2**, and misdecodes still occur, select this security level to apply the highest safety requirements.

✓ **NOTE** Selecting this option is an extreme measure against mis-decoding severely out-of-spec bar codes. Selecting this level of security significantly impairs the decoding ability of the scanner. If this level of security is required, try to improve the quality of the bar codes.



Code 39 Security Level 0
(0)



*Code 39 Security Level 1
(1)



Code 39 Security Level 2
(2)



Code 39 Security Level 3
(3)

Code 93

Enable/Disable Code 93

Parameter # 9

To enable or disable Code 93, scan the appropriate bar code below.

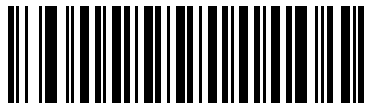

***Enable Code 93**
(1)

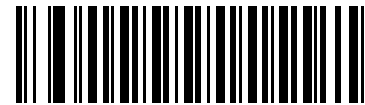

Disable Code 93
(0)

Set Lengths for Code 93

Parameter # 26, 27

The length of a code refers to the number of characters (i.e., human readable characters), including check digit(s) the code contains. Set lengths for Code 93 to any length, one or two discrete lengths, or lengths within a specific range. The default is 1 to 55.

- **One Discrete Length** - Select this option to decode only Code 93 symbols containing a selected length. Select the length using the numeric bar codes in [Appendix F, Numeric Bar Codes](#). For example, to decode only Code 93 symbols with 14 characters, scan **Code 93 - One Discrete Length**, then scan **1** followed by **4**. To correct an error or to change the selection, scan [Cancel on page F-3](#).
- **Two Discrete Lengths** - Select this option to decode only Code 93 symbols containing either of two selected lengths. Select lengths using the numeric bar codes in [Appendix F, Numeric Bar Codes](#). For example, to decode only Code 93 symbols containing either 2 or 14 characters, select **Code 93 - Two Discrete Lengths**, then scan **0, 2, 1**, and then **4**. To correct an error or to change the selection, scan [Cancel on page F-3](#).
- **Length Within Range** - Select this option to decode a Code 93 symbol with a specific length range. Select lengths using the numeric bar codes in [Appendix F, Numeric Bar Codes](#). For example, to decode Code 93 symbols containing between 4 and 12 characters, first scan **Code 93 - Length Within Range**. Then scan **0, 4, 1**, and **2** (enter a leading zero for single digit numbers). To correct an error or change the selection, scan [Cancel on page F-3](#).
- **Any Length** - Scan this option to decode Code 93 symbols containing any number of characters within the scanner's capability.

Set Lengths for Code 93 (continued)



Code 93 - One Discrete Length



Code 93 - Two Discrete Lengths



Code 93 - Length Within Range



Code 93 - Any Length

Code 11

Code 11

Parameter # 10

To enable or disable Code 11, scan the appropriate bar code below.



Enable Code 11
(1)



*Disable Code 11
(0)

Set Lengths for Code 11

Parameter # 28, 29

The length of a code refers to the number of characters (i.e., human readable characters), including check digit(s) the code contains. Set lengths for Code 11 to any length, one or two discrete lengths, or lengths within a specific range. The default is 4 to 55.

- **One Discrete Length** - Select this option to decode only Code 11 symbols containing a selected length. Select the length using the numeric bar codes in [Appendix F, Numeric Bar Codes](#). For example, to decode only Code 11 symbols with 14 characters, scan **Code 11 - One Discrete Length**, then scan **1** followed by **4**. To correct an error or to change the selection, scan [Cancel on page F-3](#).
- **Two Discrete Lengths** - Select this option to decode only Code 11 symbols containing either of two selected lengths. Select lengths using the numeric bar codes in [Appendix F, Numeric Bar Codes](#). For example, to decode only Code 11 symbols containing either 2 or 14 characters, select **Code 11 - Two Discrete Lengths**, then scan **0, 2, 1**, and then **4**. To correct an error or to change the selection, scan [Cancel on page F-3](#).
- **Length Within Range** - Select this option to decode a Code 11 symbol with a specific length range. Select lengths using numeric bar codes in [Appendix F, Numeric Bar Codes](#). For example, to decode Code 11 symbols containing between 4 and 12 characters, first scan **Code 11 - Length Within Range**. Then scan **0, 4, 1**, and **2** (enter a leading zero for single digit numbers). To correct an error or change the selection, scan [Cancel on page F-3](#).
- **Any Length** - Scan this option to decode Code 11 symbols containing any number of characters within the scanner's capability.

Set Lengths for Code 11 (continued)



Code 11 - One Discrete Length



Code 11 - Two Discrete Lengths



Code 11 - Length Within Range



Code 11 - Any Length

Code 11 Check Digit Verification

Parameter # 52

This feature allows the scanner to check the integrity of all Code 11 symbols to verify that the data complies with the specified check digit algorithm. This selects the check digit mechanism for the decoded Code 11 bar code. The options are to check for one check digit, check for two check digits, or disable the feature.

To enable this feature, scan the bar code below corresponding to the number of check digits encoded in the Code 11 symbols.

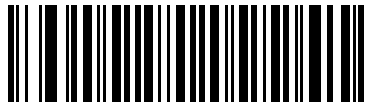

***Disable**
(0)



One Check Digit
(1)

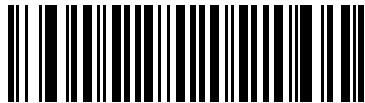

Two Check Digits
(2)

Transmit Code 11 Check Digits

Parameter # 47

This feature selects whether or not to transmit the Code 11 check digit(s).



Transmit Code 11 Check Digit(s) (Enable)

(1)

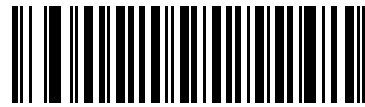

*Do Not Transmit Code 11 Check Digit(s) (Disable)

(0)



NOTE Code 11 Check Digit Verification must be enabled for this parameter to function.

Interleaved 2 of 5 (ITF)

Enable/Disable Interleaved 2 of 5

Parameter # 6

To enable or disable Interleaved 2 of 5, scan the appropriate bar code below, and select an Interleaved 2 of 5 length from the following pages.

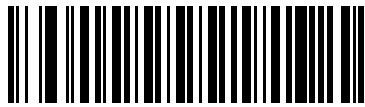

*Enable Interleaved 2 of 5
(1)

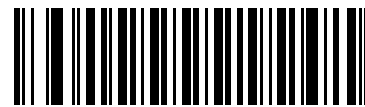

Disable Interleaved 2 of 5
(0)

Set Lengths for Interleaved 2 of 5

Parameter # 22, 23

The length of a code refers to the number of characters (i.e., human readable characters), including check digit(s) the code contains. Set lengths for I 2 of 5 to any length, one or two discrete lengths, or lengths within a specific range. The range for Interleaved 2 of 5 lengths is 0 - 55. The default is 6 to 55.

- **One Discrete Length** - Select this option to decode only I 2 of 5 symbols containing a selected length. Select the length using the numeric bar codes in [Appendix F, Numeric Bar Codes](#). For example, to decode only I 2 of 5 symbols with 14 characters, scan **I 2 of 5 - One Discrete Length**, then scan **1** followed by **4**. To correct an error or to change the selection, scan [Cancel on page F-3](#).
- **Two Discrete Lengths** - Select this option to decode only I 2 of 5 symbols containing either of two selected lengths. Select lengths using the numeric bar codes in [Appendix F, Numeric Bar Codes](#). For example, to decode only I 2 of 5 symbols containing either 2 or 14 characters, select **I 2 of 5 - Two Discrete Lengths**, then scan **0, 2, 1**, and then **4**. To correct an error or to change the selection, scan [Cancel on page F-3](#).
- **Length Within Range** - Select this option to decode an I 2 of 5 symbol with a specific length range. Select lengths using numeric bar codes in [Appendix F, Numeric Bar Codes](#). For example, to decode I 2 of 5 symbols containing between 4 and 12 characters, first scan **I 2 of 5 - Length Within Range**. Then scan **0, 4, 1**, and **2** (enter a leading zero for single digit numbers). To correct an error or change the selection, scan [Cancel on page F-3](#).
- **Any Length** - Scan this option to decode I 2 of 5 symbols containing any number of characters within the scanner's capability.

✓ **NOTE** Due to the construction of the I 2 of 5 symbology, it is possible for a scan line covering only a portion of the code to transmit as a complete scan, yielding less data than is encoded in the bar code. To prevent this, select specific lengths (I 2 of 5 - One Discrete Length, Two Discrete Lengths) for I 2 of 5 applications.

Set Lengths for Interleaved 2 of 5 (continued)



I 2 of 5 - One Discrete Length



I 2 of 5 - Two Discrete Lengths



I 2 of 5 - Length Within Range



I 2 of 5 - Any Length

I 2 of 5 Check Digit Verification

Parameter # 49

Enable this feature to check the integrity of all I 2 of 5 symbols to verify the data complies with either the specified Uniform Symbology Specification (USS), or the Optical Product Code Council (OPCC) check digit algorithm.



***Disable**
(0)



USS Check Digit
(1)



OPCC Check Digit
(2)

Transmit I 2 of 5 Check Digit

Parameter # 44

Scan the appropriate bar code below to transmit I 2 of 5 data with or without the check digit.

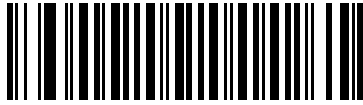

Transmit I 2 of 5 Check Digit (Enable)
(1)

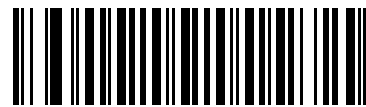

***Do Not Transmit I 2 of 5 Check Digit (Disable)**
(0)

Convert I 2 of 5 to EAN-13

Parameter # 82

Enable this parameter to convert 14-character I 2 of 5 codes to EAN-13, and transmit to the host as EAN-13. To accomplish this, the I 2 of 5 code must be enabled, and the code must have a leading zero and a valid EAN-13 check digit.

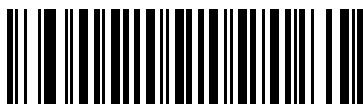

Convert I 2 of 5 to EAN-13 (Enable)
(1)

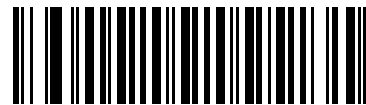

***Do Not Convert I 2 of 5 to EAN-13 (Disable)**
(0)

I 2 of 5 Security Level

Parameter # 1121

Interleaved 2 of 5 bar codes are vulnerable to misdecodes, particularly when I 2 of 5 Lengths is set to **Any Length**. The scanner offers four levels of decode security for Interleaved 2 of 5 bar codes. There is an inverse relationship between security and scanner aggressiveness. Increasing the level of security can reduce scanning aggressiveness, so select only the level of security necessary.

- **I 2 of 5 Security Level 0:** This setting allows the scanner to operate in its most aggressive state, while providing sufficient security in decoding most in-spec bar codes.
- **I 2 of 5 Security Level 1:** A bar code must be successfully read twice, and satisfy certain safety requirements before being decoded. This default setting eliminates most misdecodes.
- **I 2 of 5 Security Level 2:** Select this option with greater bar code security requirements if **Security Level 1** fails to eliminate misdecodes.
- **I 2 of 5 Security Level 3:** If you selected **Security Level 2**, and misdecodes still occur, select this security level. The highest safety requirements are applied. A bar code must be successfully read three times before being decoded.

✓ **NOTE** Selecting this option is an extreme measure against mis-decoding severely out-of-spec bar codes. Selecting this level of security significantly impairs the decoding ability of the scanner. If this level of security is required, try to improve the quality of the bar codes.



I 2 of 5 Security Level 0
(0)



*I 2 of 5 Security Level 1
(1)



I 2 of 5 Security Level 2
(2)



I 2 of 5 Security Level 3
(3)

Discrete 2 of 5 (DTF)

Enable/Disable Discrete 2 of 5

Parameter # 5

To enable or disable Discrete 2 of 5, scan the appropriate bar code below.

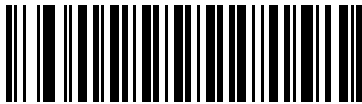

Enable Discrete 2 of 5
(1)

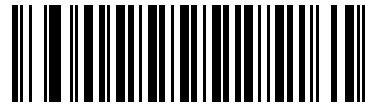

*Disable Discrete 2 of 5
(0)

Set Lengths for Discrete 2 of 5

Parameter # 20, 21

The length of a code refers to the number of characters (i.e., human readable characters), including check digit(s) the code contains. Set lengths for D 2 of 5 to any length, one or two discrete lengths, or lengths within a specific range. The range for Discrete 2 of 5 lengths is 1 - 55.

- **One Discrete Length** - Select this option to decode only D 2 of 5 symbols containing a selected length. Select the length using the numeric bar codes in [Appendix F, Numeric Bar Codes](#). For example, to decode only D 2 of 5 symbols with 14 characters, scan **D 2 of 5 - One Discrete Length**, then scan **1** followed by **4**. To correct an error or to change the selection, scan [Cancel on page F-3](#).
- **Two Discrete Lengths** - Select this option to decode only D 2 of 5 symbols containing either of two selected lengths. Select lengths using the numeric bar codes in [Appendix F, Numeric Bar Codes](#). For example, to decode only D 2 of 5 symbols containing either 2 or 14 characters, select **D 2 of 5 - Two Discrete Lengths**, then scan **0**, **2**, **1**, and then **4**. To correct an error or to change the selection, scan [Cancel on page F-3](#).
- **Length Within Range** - Select this option to decode a D 2 of 5 symbol with a specific length range. Select lengths using numeric bar codes in [Appendix F, Numeric Bar Codes](#). For example, to decode D 2 of 5 symbols containing between 4 and 12 characters, first scan **D 2 of 5 - Length Within Range**. Then scan **0**, **4**, **1**, and **2** (enter a leading zero for single digit numbers). To correct an error or change the selection, scan [Cancel on page F-3](#).
- **Any Length** - Scan this option to decode D 2 of 5 symbols containing any number of characters within the scanner's capability.

✓ **NOTE** Due to the construction of the D 2 of 5 symbology, it is possible for a scan line covering only a portion of the code to transmit as a complete scan, yielding less data than is encoded in the bar code. To prevent this, select specific lengths (**D 2 of 5 - One Discrete Length, Two Discrete Lengths**) for D 2 of 5 applications.

Set Lengths for Discrete 2 of 5 (continued)



D 2 of 5 - One Discrete Length



D 2 of 5 - Two Discrete Lengths



D 2 of 5 - Length Within Range



D 2 of 5 - Any Length

Codabar (NW - 7)

Enable/Disable Codabar

Parameter # 7

To enable or disable Codabar, scan the appropriate bar code below.

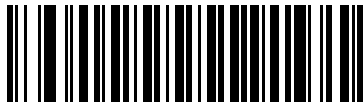

***Enable Codabar
(1)**



**Disable Codabar
(0)**

Set Lengths for Codabar

Parameter # 24, 25

The length of a code refers to the number of characters (i.e., human readable characters), including check digit(s) the code contains. Set lengths for Codabar to any length, one or two discrete lengths, or lengths within a specific range. The default is 4 to 55.

- **One Discrete Length** - Select this option to decode only Codabar symbols containing a selected length. Select the length using the numeric bar codes in [Appendix F, Numeric Bar Codes](#). For example, to decode only Codabar symbols with 14 characters, scan **Codabar - One Discrete Length**, then scan **1** followed by **4**. To correct an error or to change the selection, scan [Cancel on page F-3](#).
- **Two Discrete Lengths** - Select this option to decode only Codabar symbols containing either of two selected lengths. Select lengths using the numeric bar codes in [Appendix F, Numeric Bar Codes](#). For example, to decode only Codabar symbols containing either 2 or 14 characters, select **Codabar - Two Discrete Lengths**, then scan **0, 2, 1**, and then **4**. To correct an error or to change the selection, scan [Cancel on page F-3](#).
- **Length Within Range** - Select this option to decode a Codabar symbol with a specific length range. Select lengths using numeric bar codes in [Appendix F, Numeric Bar Codes](#). For example, to decode Codabar symbols containing between 4 and 12 characters, first scan **Codabar - Length Within Range**. Then scan **0, 4, 1**, and **2** (enter a leading zero for single digit numbers). To correct an error or change the selection, scan [Cancel on page F-3](#).
- **Any Length** - Scan this option to decode Codabar symbols containing any number of characters within the scanner's capability.

Set Lengths for Codabar (continued)



Codabar - One Discrete Length



Codabar - Two Discrete Lengths



Codabar - Length Within Range



Codabar - Any Length

CLSI Editing

Parameter # 54

Enable this parameter to strip the start and stop characters and insert a space after the first, fifth, and tenth characters of a 14-character Codabar symbol. Enable this feature if the host system requires this data format.

✓ **NOTE** Symbol length does not include start and stop characters.

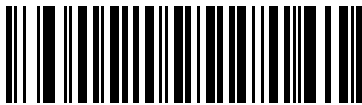

Enable CLSI Editing
(1)

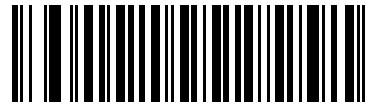

*Disable CLSI Editing
(0)

NOTIS Editing

Parameter # 55

Enable this parameter to strip the start and stop characters from a decoded Codabar symbol. Enable this feature if the host system requires this data format.

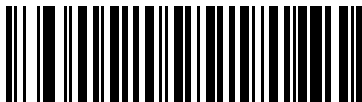

Enable NOTIS Editing
(1)



*Disable NOTIS Editing
(0)

Codabar Upper or Lower Case Start/Stop Characters Detection

Parameter # 855

Select whether to detect upper case or lower case Codabar start/stop characters.

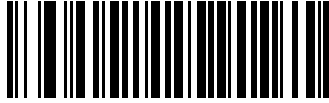

Lower Case
(1)

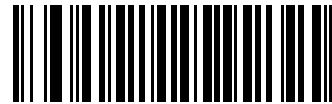

***Upper Case**
(0)

MSI

Enable/Disable MSI

Parameter # 11

To enable or disable MSI, scan the appropriate bar code below.

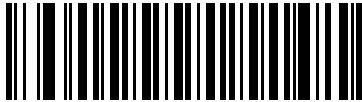

Enable MSI
(1)

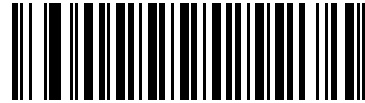

*Disable MSI
(0)

Set Lengths for MSI

Parameter # 30, 31

The length of a code refers to the number of characters (i.e., human readable characters), including check digit(s) the code contains. Set lengths for MSI to any length, one or two discrete lengths, or lengths within a specific range. The default is 4 to 55.

- **One Discrete Length** - Select this option to decode only MSI symbols containing a selected length. Select the length using the numeric bar codes in [Appendix F, Numeric Bar Codes](#). For example, to decode only MSI symbols with 14 characters, scan **MSI - One Discrete Length**, then scan **1** followed by **4**. To correct an error or to change the selection, scan [Cancel on page F-3](#).
- **Two Discrete Lengths** - Select this option to decode only MSI symbols containing either of two selected lengths. Select lengths using the numeric bar codes in [Appendix F, Numeric Bar Codes](#). For example, to decode only MSI symbols containing either 2 or 14 characters, select **MSI - Two Discrete Lengths**, then scan **0, 2, 1**, and then **4**. To correct an error or to change the selection, scan [Cancel on page F-3](#).
- **Length Within Range** - Select this option to decode a MSI symbol with a specific length range. Select lengths using numeric bar codes in [Appendix F, Numeric Bar Codes](#). For example, to decode MSI symbols containing between 4 and 12 characters, first scan **MSI - Length Within Range**. Then scan **0, 4, 1**, and **2** (enter a leading zero for single digit numbers). To correct an error or change the selection, scan [Cancel on page F-3](#).
- **Any Length** - Scan this option to decode MSI symbols containing any number of characters within the scanner's capability.

Set Lengths for MSI (continued)

- ✓ **NOTE** Due to the construction of the MSI symbology, it is possible for a scan line covering only a portion of the code to transmit as a complete scan, yielding less data than is encoded in the bar code. To prevent this, select specific lengths (**MSI - One Discrete Length**, **Two Discrete Lengths**) for MSI applications.

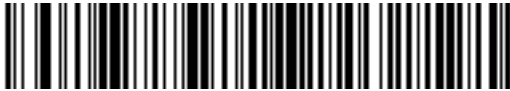

MSI - One Discrete Length



MSI - Two Discrete Lengths

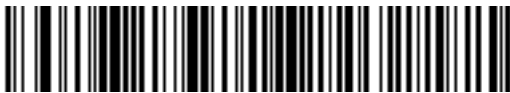

MSI - Length Within Range



MSI - Any Length

MSI Check Digits

Parameter # 50

With MSI symbols, one check digit is mandatory and always verified by the reader. The second check digit is optional. If the MSI codes include two check digits, scan the **Two MSI Check Digits** bar code to enable verification of the second check digit.

See [MSI Check Digit Algorithm on page 4-57](#) for the selection of second digit algorithms.

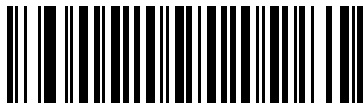

***One MSI Check Digit
(0)**

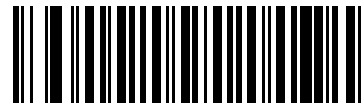

**Two MSI Check Digits
(1)**

Transmit MSI Check Digit(s)

Parameter # 46

Scan a bar code below to transmit MSI data with or without the check digit.

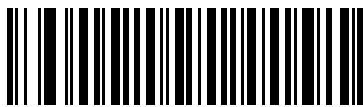

**Transmit MSI Check Digit(s) (Enable)
(1)**

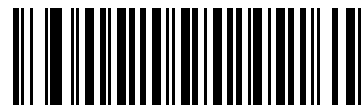

***Do Not Transmit MSI Check Digit(s) (Disable)
(0)**

MSI Check Digit Algorithm

Parameter # 51

Two algorithms are possible for the verification of the second MSI check digit. Select the bar code below corresponding to the algorithm used to encode the check digit.

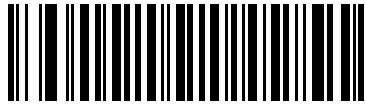

MOD 10/MOD 11
(0)

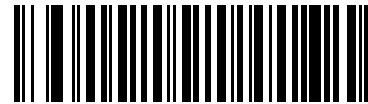

*MOD 10/MOD 10
(1)

Chinese 2 of 5

Enable/Disable Chinese 2 of 5

Parameter # 408

To enable or disable Chinese 2 of 5, scan the appropriate bar code below.



Enable Chinese 2 of 5
(1)

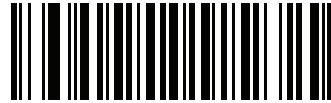

***Disable Chinese 2 of 5**
(0)

Matrix 2 of 5

Enable/Disable Matrix 2 of 5

Parameter # 618

To enable or disable Matrix 2 of 5, scan the appropriate bar code below.



**Enable Matrix 2 of 5
(1)**



***Disable Matrix 2 of 5
(0)**

Set Lengths for Matrix 2 of 5

Parameter # 619, 620

The length of a code refers to the number of characters (i.e., human readable characters), including check digit(s) the code contains. Set lengths for Matrix 2 of 5 to any length, one or two discrete lengths, or lengths within a specific range. The default is 4 to 55.

- **One Discrete Length** - Select this option to decode only Matrix 2 of 5 symbols containing a selected length. Select the length using the numeric bar codes in [Appendix F, Numeric Bar Codes](#). For example, to decode only Matrix 2 of 5 symbols with 14 characters, scan **Matrix 2 of 5 - One Discrete Length**, then scan **1** followed by **4**. To correct an error or to change the selection, scan [Cancel on page F-3](#).
- **Two Discrete Lengths** - Select this option to decode only Matrix 2 of 5 symbols containing either of two selected lengths. Select lengths using the numeric bar codes in [Appendix F, Numeric Bar Codes](#). For example, to decode only Matrix 2 of 5 symbols containing either 2 or 14 characters, select **Matrix 2 of 5 - Two Discrete Lengths**, then scan **0, 2, 1**, and then **4**. To correct an error or to change the selection, scan [Cancel on page F-3](#).
- **Length Within Range** - Select this option to decode a Matrix 2 of 5 symbol with a specific length range. Select lengths using the numeric bar codes in [Appendix F, Numeric Bar Codes](#). For example, to decode Matrix 2 of 5 symbols containing between 4 and 12 characters, first scan **Matrix 2 of 5 - Length Within Range**. Then scan **0, 4, 1**, and **2** (enter a leading zero for single digit numbers). To correct an error or change the selection, scan [Cancel on page F-3](#).
- **Any Length** - Scan this option to decode Matrix 2 of 5 symbols containing any number of characters within the scanner's capability.

Set Lengths for Matrix 2 of 5 (continued)



***Matrix 2 of 5 - One Discrete Length**



Matrix 2 of 5 - Two Discrete Lengths



Matrix 2 of 5 - Length Within Range



Matrix 2 of 5 - Any Length

Matrix 2 of 5 Check Digit

Parameter # 622

The check digit is the last character of the symbol used to verify the integrity of the data. Scan the appropriate bar code below to transmit the bar code data with or without the Matrix 2 of 5 check digit.



Enable Matrix 2 of 5 Check Digit
(1)

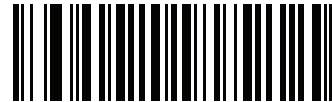

*Disable Matrix 2 of 5 Check Digit
(0)

Transmit Matrix 2 of 5 Check Digit

Parameter # 623

Scan a bar code below to transmit Matrix 2 of 5 data with or without the check digit.

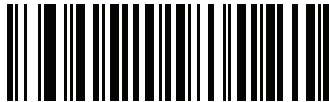

Transmit Matrix 2 of 5 Check Digit
(1)



*Do Not Transmit Matrix 2 of 5 Check Digit
(0)

Korean 3 of 5

Enable/Disable Korean 3 of 5

Parameter # 581

To enable or disable Korean 3 of 5, scan the appropriate bar code below.

✓ **NOTE** The length for Korean 3 of 5 is fixed at 6.



**Enable Korean 3 of 5
(1)**



***Disable Korean 3 of 5
(0)**

Inverse 1D

Parameter # 586

This parameter sets the 1D inverse scanner setting. Options are:

- **Regular Only** - the scanner decodes regular 1D bar codes only.
- **Inverse Only** - the scanner decodes inverse 1D bar codes only.
- **Inverse Autodetect** - the scanner decodes both regular and inverse 1D bar codes.



***Regular**
(0)



Inverse Only
(1)



Inverse Autodetect
(2)

GS1 DataBar

The variants of GS1 DataBar are DataBar-14, DataBar Expanded, and DataBar Limited. The limited and expanded versions have stacked variants. Scan the appropriate bar codes to enable or disable each variant of GS1 DataBar.

GS1 DataBar-14

Parameter # 338

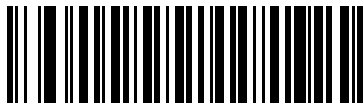

***Enable GS1 DataBar-14
(1)**

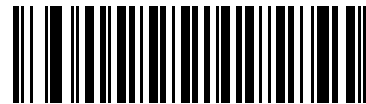

**Disable GS1 DataBar-14
(0)**

GS1 DataBar Limited

Parameter # 339

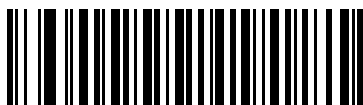

***Enable GS1 DataBar Limited
(1)**

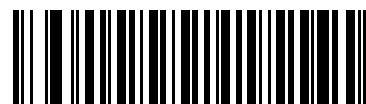

**Disable GS1 DataBar Limited
(0)**

GS1 DataBar Expanded

Parameter # 340

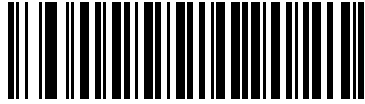

***Enable GS1 DataBar Expanded
(1)**

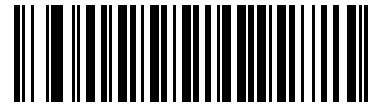

**Disable GS1 DataBar Expanded
(0)**

Convert GS1 DataBar to UPC/EAN

Parameter # 397

This parameter only applies to GS1 DataBar-14 and GS1 DataBar Limited symbols not decoded as part of a Composite symbol. Enable this to strip the leading '010' from DataBar-14 and DataBar Limited symbols encoding a single zero as the first digit, and report the bar code as EAN-13.

For bar codes beginning with two or more zeros but not six zeros, this parameter strips the leading '0100' and reports the bar code as UPC-A. The UPC-A Preamble parameter that transmits the system character and country code applies to converted bar codes. Note that neither the system character nor the check digit can be stripped.



**Enable Convert GS1 DataBar to UPC/EAN
(1)**



***Disable Convert GS1 DataBar to UPC/EAN
(0)**

GS1 DataBar Limited Security Level

Parameter # 728

The scanner offers four levels of decode security for GS1 DataBar Limited bar codes. There is an inverse relationship between security and scanner aggressiveness. Increasing the level of security may result in reduced aggressiveness in scanning, so choose only that level of security necessary.

- Level 1 – No clear margin required. This complies with the original GS1 standard, yet might result in erroneous decoding of the DataBar Limited bar code when scanning some UPC symbols that start with digits “9” and “7”
- Level 2 – Automatic risk detection. This level of security may result in erroneous decoding of DataBar Limited bar codes when scanning some UPC symbols. The scanner defaults to Level 3, otherwise to Level 1.
- Level 3 – Security level reflects newly proposed GS1 standard that requires a 5 times trailing clear margin.
- Level 4 – Security level extends beyond the standard required by GS1. This level of security requires a 5 times leading and trailing clear margin.

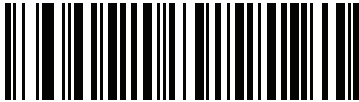

GS1 DataBar Limited Security Level 1
(1)

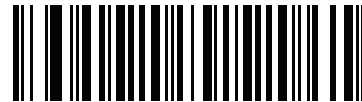

GS1 DataBar Limited Security Level 2
(2)



***GS1 DataBar Limited Security Level 3**
(3)



GS1 DataBar Limited Security Level 4
(4)

Composite

Composite CC-C

Parameter # 341

Scan a bar code below to enable or disable Composite bar codes of type CC-C.



Enable CC-C
(1)

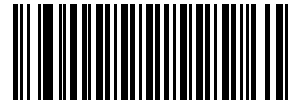

*Disable CC-C
(0)

Composite CC-A/B

Parameter # 342

Scan a bar code below to enable or disable Composite bar codes of type CC-A/B.

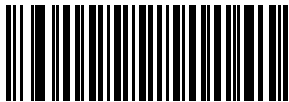

Enable CC-A/B
(1)



*Disable CC-A/B
(0)

Composite TLC-39

Parameter # 371

Scan a bar code below to enable or disable Composite bar codes of type TLC-39.



Enable TLC39
(1)

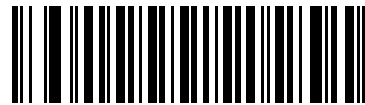

*Disable TLC39
(0)

UPC Composite Mode

Parameter # 344

Select an option for linking UPC symbols with a 2D symbol during transmission as if they were one symbol:

- Select **UPC Never Linked** to transmit UPC bar codes regardless of whether a 2D symbol is detected.
- Select **UPC Always Linked** to transmit UPC bar codes and the 2D portion.
If 2D is not present, the UPC bar code does not transmit.
- If you select **Autodiscriminate UPC Composites**, the scanner determines if there is a 2D portion, then transmits the UPC, as well as the 2D portion if present.



*UPC Never Linked
(0)



UPC Always Linked
(1)



Autodiscriminate UPC Composites
(2)

GS1-128 Emulation Mode for UCC/EAN Composite Codes

Parameter # 427

Select whether to enable or disable this mode.



**Enable GS1-128 Emulation Mode for
UCC/EAN Composite Codes
(1)**



***Disable GS1-128 Emulation Mode for
UCC/EAN Composite Codes
(0)**

Postal Codes

US Postnet

Parameter # 89

To enable or disable US Postnet, scan the appropriate bar code below.



**Enable US Postnet
(1)**



***Disable US Postnet
(0)**

US Planet

Parameter # 90

To enable or disable US Planet, scan the appropriate bar code below.



**Enable US Planet
(1)**



***Disable US Planet
(0)**

Transmit US Postal Check Digit

Parameter # 95

Select whether to transmit US Postal data, which includes both US Postnet and US Planet, with or without the check digit.

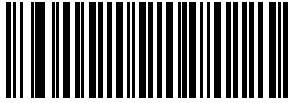

***Transmit US Postal Check Digit
(1)**

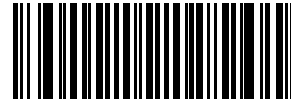

**Do Not Transmit US Postal Check Digit
(0)**

UK Postal

Parameter # 91

To enable or disable UK Postal, scan the appropriate bar code below.



**Enable UK Postal
(1)**



***Disable UK Postal
(0)**

Transmit UK Postal Check Digit

Parameter # 96

Select whether to transmit UK Postal data with or without the check digit.



***Transmit UK Postal
Check Digit
(1)**



**Do Not Transmit UK Postal Check Digit
(0)**

Japan Postal

Parameter # 290

To enable or disable Japan Postal, scan the appropriate bar code below.



**Enable Japan Postal
(1)**



***Disable Japan Postal
(0)**

Australia Post

Parameter # 291

To enable or disable Australia Post, scan the appropriate bar code below.



**Enable Australia Post
(1)**



***Disable Australia Post
(0)**

Australia Post Format

Parameter # 718

To select one of the following formats for Australia Post, scan the appropriate bar code below:

- **Autodiscriminate** (or Smart mode) - Attempt to decode the Customer Information Field using the N and C Encoding Tables.

✓ **NOTE** This option increases the risk of misdecodes because the encoded data format does not specify the Encoding Table used for encoding.

- **Raw Format** - Output raw bar patterns as a series of numbers 0 through 3.
- **Alphanumeric Encoding** - Decode the Customer Information Field using the C Encoding Table.
- **Numeric Encoding** - Decode the Customer Information Field using the N Encoding Table.

For more information on Australia Post Encoding Tables, refer to the *Australia Post Customer Barcoding Technical Specifications* available at <http://www.auspost.com.au>.



***Autodiscriminate
(0)**



**Raw Format
(1)**



**Alphanumeric Encoding
(2)**



**Numeric Encoding
(3)**

Netherlands KIX Code

Parameter # 326

To enable or disable Netherlands KIX Code, scan the appropriate bar code below.



**Enable Netherlands KIX Code
(1)**



***Disable Netherlands KIX Code
(0)**

USPS 4CB/One Code/Intelligent Mail

Parameter # 592

To enable or disable USPS 4CB/One Code/Intelligent Mail, scan the appropriate bar code below.



**Enable USPS 4CB/One Code/Intelligent Mail
(1)**



***Disable USPS 4CB/One Code/Intelligent Mail
(0)**

UPU FICS Postal

Parameter # 611

To enable or disable UPU FICS Postal, scan the appropriate bar code below.



**Enable UPU FICS Postal
(1)**

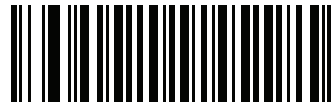

***Disable UPU FICS Postal
(0)**

2D Symbologies

Enable/Disable PDF417

Parameter # 15

To enable or disable PDF417, scan the appropriate bar code below.



***Enable PDF417
(1)**



**Disable PDF417
(0)**

Enable/Disable MicroPDF417

Parameter # 227

To enable or disable MicroPDF417, scan the appropriate bar code below.



**Enable MicroPDF417
(1)**



***Disable MicroPDF417
(0)**

Code 128 Emulation

Parameter # 123

Enable this parameter to transmit data from certain MicroPDF417 symbols as Code 128. *AIM Code ID Character (1) on page 3-21* must be selected for this parameter to work.

Enable Code 128 Emulation to transmit these MicroPDF417 symbols with one of the following prefixes:

-]C1 if the first codeword is 903-905
-]C2 if the first codeword is 908 or 909
-]C0 if the first codeword is 910 or 911

Disable Code 128 Emulation to transmit these MicroPDF417 symbols with one of the following prefixes:

-]L3 if the first codeword is 903-905
-]L4 if the first codeword is 908 or 909
-]L5 if the first codeword is 910 or 911

Scan a bar code below to enable or disable Code 128 Emulation.



NOTE Linked MicroPDF codewords 906, 907, 912, 914, and 915 are not supported. Use GS1 Composites instead.



**Enable Code 128 Emulation
(1)**



***Disable Code 128 Emulation
(0)**

Data Matrix

Parameter # 292

To enable or disable Data Matrix, scan the appropriate bar code below.



***Enable Data Matrix
(1)**



**Disable Data Matrix
(0)**

Data Matrix Inverse

Parameter # 588

This parameter sets the Data Matrix inverse scanner setting. Options are:

- **Regular Only** - the scanner decodes regular Data Matrix bar codes only.
- **Inverse Only** - the scanner decodes inverse Data Matrix bar codes only.
- **Inverse Autodetect** - the scanner decodes both regular and inverse Data Matrix bar codes.



**Regular
(0)**



**Inverse Only
(1)**



***Inverse Autodetect
(2)**

Decode Mirror Images (Data Matrix Only)

Parameter # 537

Select an option for decoding mirror image Data Matrix bar codes:

- Always - decode only Data Matrix bar codes that are mirror images
- Never - do not decode Data Matrix bar codes that are mirror images
- Auto - decode both mirrored and unmirrored Data Matrix bar codes.



Never
(0)



Always
(1)



*** Auto**
(2)

Maxicode

Parameter # 294

To enable or disable Maxicode, scan the appropriate bar code below.



**Enable Maxicode
(1)**



***Disable Maxicode
(0)**

QR Code

Parameter # 293

To enable or disable QR Code, scan the appropriate bar code below.



***Enable QR Code
(1)**



**Disable QR Code
(0)**

QR Inverse

Parameter # 587

This parameter sets the QR inverse scanner setting. Options are:

- **Regular Only** - the scanner decodes regular QR bar codes only.
- **Inverse Only** - the scanner decodes inverse QR bar codes only.
- **Inverse Autodetect** - the scanner decodes both regular and inverse QR bar codes.



***Regular**
(0)



Inverse Only
(1)



Inverse Autodetect
(2)

MicroQR

Parameter # 573

To enable or disable MicroQR, scan the appropriate bar code below.



***Enable MicroQR**
(1)



Disable MicroQR
(0)

Aztec

Parameter # 574

To enable or disable Aztec, scan the appropriate bar code below.



***Enable Aztec**
(1)



Disable Aztec
(0)

Aztec Inverse

Parameter # 589

This parameter sets the Aztec inverse scanner setting. Options are:

- **Regular Only** - the scanner decodes regular Aztec bar codes only.
- **Inverse Only** - the scanner decodes inverse Aztec bar codes only.
- **Inverse Autodetect** - the scanner decodes both regular and inverse Aztec bar codes.



Regular
(0)



Inverse Only
(1)



***Inverse Autodetect**
(2)

Han Xin

Parameter # 1167

To enable or disable Han Xin, scan the appropriate bar code below.



Enable Han Xin
(1)

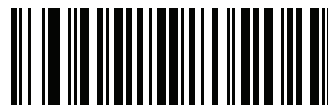

***Disable Han Xin**
(0)

Han Xin Inverse

Parameter # 1168

Select a Han Xin inverse scanner setting:

- **Regular Only** - the scanner decodes Han Xin bar codes with normal reflectance only.
- **Inverse Only** - the scanner decodes Han Xin bar codes with inverse reflectance only.
- **Inverse Autodetect** - the scanner decodes both regular and inverse Han Xin bar codes.



***Regular**
(0)



Inverse Only
(1)



Inverse Autodetect
(2)

Symbology-Specific Security Levels

Redundancy Level

Parameter # 78

The scanner offers four levels of decode redundancy. Select higher redundancy levels for decreasing levels of bar code quality. As redundancy levels increase, the scanner's aggressiveness decreases.

Select the redundancy level appropriate for the bar code quality.

Redundancy Level 1

The following code types must be successfully read twice before being decoded:

Table 4-2 *Redundancy Level 1 Codes*

Code Type	Code Length
Codabar	8 characters or less
MSI	4 characters or less
D 2 of 5	8 characters or less
I 2 of 5	8 characters or less

Redundancy Level 2

The following code types must be successfully read twice before being decoded:

Table 4-3 *Redundancy Level 2 Codes*

Code Type	Code Length
All	All

Redundancy Level 3

Code types other than the following must be successfully read twice before being decoded. The following codes must be read three times:

Table 4-4 *Redundancy Level 3 Codes*

Code Type	Code Length
MSI	4 characters or less
D 2 of 5	8 characters or less
I 2 of 5	8 characters or less
Codabar	8 characters or less

Redundancy Level 4

The following code types must be successfully read three times before being decoded:

Table 4-5 *Redundancy Level 4 Codes*

Code Type	Code Length
All	All

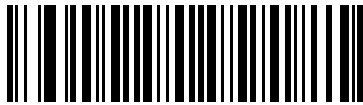

***Redundancy Level 1
(1)**

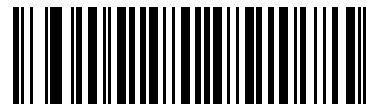

**Redundancy Level 2
(2)**



**Redundancy Level 3
(3)**

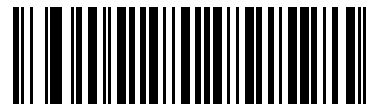

**Redundancy Level 4
(4)**

Bi-directional Redundancy

Parameter # 67

This parameter is only valid when a *Redundancy Level* is enabled. When this parameter is enabled, the scanner must scan a bar code successfully in both directions (forward and reverse) before decoding.



**Enable Bi-directional Redundancy
(1)**



***Disable Bi-directional Redundancy
(0)**

Security Level

Parameter # 77

The scanner offers four levels of decode security for delta bar codes, which include the Code 128 family, UPC/EAN, and Code 93. Select increasing levels of security for decreasing levels of bar code quality. There is an inverse relationship between security and scanner aggressiveness, so choose only that level of security necessary for any given application.

- **Security Level 0:** This setting allows the scanner to operate in its most aggressive state, while providing sufficient security in decoding most “in-spec” bar codes.
- **Security Level 1:** This default setting eliminates most misdecodes.
- **Security Level 2:** Select this option if Security level 1 fails to eliminate misdecodes.
- **Security Level 3:** If you selected Security Level 2 and misdecodes still occur, select this security level. Be advised, selecting this option is an extreme measure against mis-decoding severely out of spec bar codes. Selecting this level of security significantly impairs the decoding ability of the scanner. If you need this level of security, try to improve the quality of the bar codes.

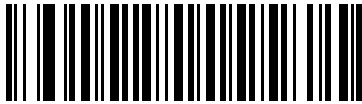

Security Level 0
(0)

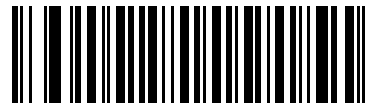

***Security Level 1**
(1)



Security Level 2
(2)



Security Level 3
(3)

Intercharacter Gap Size

Parameter # 381

The Code 39 and Codabar symbologies have an intercharacter gap that is typically quite small. Due to various bar code-printing technologies, this gap can grow larger than the maximum size allowed, preventing the scanner from decoding the symbol. If this problem occurs, scan the **Large Intercharacter Gaps** parameter to tolerate these out-of-specification bar codes.



***Normal Intercharacter Gaps**
(6)



Large Intercharacter Gaps
(10)

CHAPTER 5 123SCAN2

Introduction

You can configure the CS4070 by scanning a 123Scan2 generated programming bar code. The CS4070 can not communicate directly with 123Scan2 via a USB cable, and you can not use 123Scan2 to update its firmware.

For instructions on updating firmware, see *Updating Scanner Firmware on page 1-8*.

For more information on 123Scan², go to: <http://www.zebra.com/123Scan2>

CHAPTER 6 ADVANCED DATA FORMATTING

Introduction

Advanced Data Formatting (ADF) is a means of customizing data before transmission to the host device. Use ADF to edit scan data to suit requirements. Implement ADF by scanning a related series of bar codes which program the scanner with ADF rules.

The scanner stores ADF rules in persistent memory and retains them through a battery replacement. The CS4070 supports all ADF rules **except**:

- LED rules, beeper rules, pause duration
- Rules containing non-ASCII characters, e.g., if a rule is set to send **Alt {** this is removed from the rule.

For information and programming bar codes for ADF, refer to the *Advanced Data Formatting Programmer Guide*, p/n 72E-69680-xx.

CHAPTER 7 MAINTENANCE AND TECHNICAL SPECIFICATIONS

Introduction

This chapter provides suggested scanner maintenance, troubleshooting, and technical specifications.

Maintenance

Cleaning the scan window is the only maintenance required. A dirty window can affect scanning accuracy.

- Do not allow any abrasive material to touch the window.
- Remove any dirt particles with a damp cloth.
- Wipe the window using a tissue moistened with ammonia/water.
- Do not spray water or other cleaning liquids directly onto the window.

Troubleshooting

Table 7-1 *Troubleshooting*

Problem	Possible Causes	Possible Solutions
Imager comes on, but scanner does not decode the bar code.	Scanner is not programmed for the correct bar code type.	Ensure the scanner is programmed to read the type of bar code being scanned.
	Bar code symbol is unreadable.	Check the symbol to ensure it is not defaced. Try scanning test bar codes of the same bar code type. See Appendix E, Sample Bar Codes for test bar codes.
	Bar code is out of range of the scanner.	Move scanner closer to or further from bar code.
Scanner emits long beeps for 5 seconds when scanning a bar code.	Memory is full.	Download bar code data to the host and clear the memory.
Scanner does not decode the bar code and the LED blinks amber, red, green.	Scanner needs to be reset.	Press the reset button. See Figure 1-1 on page 1-1 for the location.
		Scan the Restore Defaults bar code below. 
Scanner LED turns solid red for a few seconds.	Battery is low.	Charge the battery. See Charging Batteries on page 1-4 .
Scanner does not fully charge.	Attempt to charge on a non-powered USB hub.	Connect the scanner to a powered USB hub (5V, 500mA max).
Bluetooth LED turns off.	Scanner is out of range of the Bluetooth host.	Move closer to the host and press any key to re-pair with the host.
Can't see the scanner drive after connecting scanner to host.	Scanner is mapping to a drive used by another device.	Use Windows' map drive function to change the scanner drive letter.
Program connecting Broadcom stack to HID device.	Some versions of Broadcom stack experience issues when connecting to HID devices.	See Set HID CoD to Zero on page 3-12 .



NOTE If problems still occur, contact the distributor or support. See [page xvi](#) for contact information.

Before contacting support, view the **sysinfo.txt** file in the **\Parameters** folder on the CS4070. This indicates the device's serial number, software version, Bluetooth version, and scan engine version and is useful when troubleshooting the scanner.

Technical Specifications

For the latest technical specification information for the CS4070, visit: <http://www.zebra.com/CS4070>

APPENDIX A STANDARD DEFAULT PARAMETERS

Table A-1 *Default Table*

Parameter	Parameter Number (Hex)	Factory Default	Page Number
Reset Factory Defaults	N/A	N/A	3-4
Set Date	N/A	N/A	3-5
Set Time	N/A	N/A	3-5
Cancel Date and Time Settings	N/A	N/A	3-5
Bluetooth Options			
Pairing Bar Code Format	N/A	N/A	3-7
Bluetooth Unpair	N/A	N/A	3-8
Bluetooth Profile	N/A	HID	3-8
Clear Data	N/A	N/A	3-9
Auto-reconnect	N/A	Disable	3-10
Connection Interval	N/A	30 seconds	3-11
HID Security	911	High	3-11
Radio Output Power	N/A	Class 1	3-12
Set HID CoD to Zero	N/A	Disable	3-12
User Preferences			
Beeper Volume	140	High	3-14
Beeper Tone	145	Medium Frequency	3-15
Mute Beeper	N/A	Do Not Mute	3-15
Decode Pager Motor	613	Enable	3-16

Table A-1 *Default Table (Continued)*

Parameter	Parameter Number (Hex)	Factory Default	Page Number
Decode Pager Motor Duration	626	200 msec	3-16
Picklist Mode	402	Disabled Always	3-18
Fuzzy 1D Processing	514	Enable	3-18
Mirrored Image	624	Disable	3-19
Mobile Phone/Display Mode	716	Disable	3-19
PDF Prioritization	719	Disable	3-20
PDF Prioritization Timeout	720	200 ms	3-20
Data Options			
Transmit Code ID Character	45	None	3-21
Prefix Value	99, 105	7013 <CR><LF>	3-22
Suffix 1 Value Suffix 2 Value	98, 104 100, 106	7013 <CR><LF>	3-22
Transmit "No Read" Message	94	Disable	3-24
Scan Data Transmission Format	235	Data as is	3-23
Version Options			
Send Firmware Version	N/A		3-25
Send Scan Engine Version	N/A		3-25
Send Dongle Version	N/A		3-25
Symbologies			
Enable/Disable All Code Types			4-7
UPC/EAN			
UPC-A	1	Enable	4-8
UPC-E	2	Enable	4-8
UPC-E1	12	Disable	4-9
EAN-8/JAN 8	4	Enable	4-9
EAN-13/JAN 13	3	Enable	4-10
Bookland EAN	83	Disable	4-10
Bookland ISBN Format	576	ISBN-10	4-11
Decode UPC/EAN/JAN Supplementals (2 and 5 digits)	16	Ignore	4-12

Table A-1 *Default Table (Continued)*

Parameter	Parameter Number (Hex)	Factory Default	Page Number
User-Programmable Supplementals		000	4-15
Supplemental 1:	579		
Supplemental 2:	580		
UPC/EAN/JAN Supplemental Redundancy	80	10	4-15
Decode UPC/EAN/JAN Supplemental AIM ID	672	Combined	4-16
Transmit UPC-A Check Digit	40	Enable	4-17
Transmit UPC-E Check Digit	41	Enable	4-17
Transmit UPC-E1 Check Digit	42	Enable	4-18
UPC-A Preamble	34	System Character	4-19
UPC-E Preamble	35	System Character	4-20
UPC-E1 Preamble	36	System Character	4-21
Convert UPC-E to A	37	Disable	4-22
Convert UPC-E1 to A	38	Disable	4-22
EAN-8/JAN-8 Extend	39	Disable	4-23
UCC Coupon Extended Code	85	Disable	4-23
Coupon Report	730	New Coupon Format	4-24
ISSN EAN	617	Disable	4-24
Code 128			
Code 128	8	Enable	4-25
Set Length(s) for Code 128	209, 210	1 to 55	4-25
GS1-128 (formerly UCC/EAN-128)	14	Enable	4-27
ISBT 128	84	Enable	4-27
ISBT Concatenation	577	Autodiscriminate	4-28
Check ISBT Table	578	Enable	4-29
ISBT Concatenation Redundancy	223	10	4-29
Code 128 Security Level	751	Security Level 1	4-30
Code 39			
Code 39	0	Enable	4-31
Trioptic Code 39	13	Disable	4-31
Convert Code 39 to Code 32 (Italian Pharmacy Code)	86	Disable	4-32
Code 32 Prefix	231	Disable	4-32

Table A-1 *Default Table (Continued)*

Parameter	Parameter Number (Hex)	Factory Default	Page Number
Set Length(s) for Code 39	18, 19	1 to 55	4-33
Code 39 Check Digit Verification	48	Disable	4-34
Transmit Code 39 Check Digit	43	Disable	4-34
Code 39 Full ASCII Conversion	17	Disable	4-35
Code 39 Security Level	750	Security Level 1	4-36
Code 93			
Code 93	9	Enable	4-37
Set Length(s) for Code 93	26, 27	1 to 55	4-37
Code 11			
Code 11	10	Disable	4-39
Set Lengths for Code 11	28, 29	4 to 55	4-39
Code 11 Check Digit Verification	52	Disable	4-41
Transmit Code 11 Check Digit(s)	47	Disable	4-42
Interleaved 2 of 5 (ITF)			
Interleaved 2 of 5 (ITF)	6	Enable	4-43
Set Lengths for I 2 of 5	22, 23	6 to 55	4-43
I 2 of 5 Check Digit Verification	49	Disable	4-45
Transmit I 2 of 5 Check Digit	44	Disable	4-46
Convert I 2 of 5 to EAN 13	82	Disable	4-46
I 2 of 5 Security Level	1121	Security Level 1	4-47
Discrete 2 of 5 (DTF)			
Discrete 2 of 5	5	Disable	4-48
Set Length(s) for D 2 of 5	20, 21	1 to 55	4-48
Codabar (NW - 7)			
Codabar	7	Enable	4-50
Set Lengths for Codabar	24, 25	4 to 55	4-50
CLSI Editing	54	Disable	4-52
NOTIS Editing	55	Disable	4-52
Codabar Upper or Lower Case Start/Stop Characters Detection	855	Upper Case	4-53

Table A-1 Default Table (Continued)

Parameter	Parameter Number (Hex)	Factory Default	Page Number
MSI			
MSI	11	Disable	4-54
Set Length(s) for MSI	30, 31	4 to 55	4-54
MSI Check Digits	50	One	4-56
Transmit MSI Check Digit	46	Disable	4-56
MSI Check Digit Algorithm	51	Mod 10/Mod 10	4-57
Chinese 2 of 5			
Chinese 2 of 5	408	Disable	4-58
Matrix 2 of 5			
Matrix 2 of 5	618	Disable	4-59
Matrix 2 of 5 Lengths	619, 620	4 to 55	4-59
Matrix 2 of 5 Check Digit	622	Disable	4-61
Transmit Matrix 2 of 5 Check Digit	623	Disable	4-61
Korean 3 of 5			
Korean 3 of 5	581	Disable	4-62
Inverse 1D	586	Regular	4-63
GS1 DataBar			
GS1 DataBar-14	338	Enable	4-64
GS1 DataBar Limited	339	Enable	4-64
GS1 DataBar Expanded	340	Enable	4-65
Convert GS1 DataBar to UPC/EAN	397	Disable	4-65
GS1 DataBar Limited Security Level	728	Level 3	4-66
Composite			
Composite CC-C	341	Disable	4-67
Composite CC-A/B	342	Disable	4-67
Composite TLC-39	371	Disable	4-68
UPC Composite Mode	344	Never Linked	4-68
GS1-128 Emulation Mode for UCC/EAN Composite Codes	427	Disable	4-69

Table A-1 *Default Table (Continued)*

Parameter	Parameter Number (Hex)	Factory Default	Page Number
Postal Codes			
US Postnet	89	Disable	4-70
US Planet	90	Disable	4-70
Transmit US Postal Check Digit	95	Enable	4-71
UK Postal	91	Disable	4-71
Transmit UK Postal Check Digit	96	Enable	4-72
Japan Postal	290	Disable	4-72
Australia Post	291	Disable	4-73
Australia Post Format	718	Autodiscriminate	4-74
Netherlands KIX Code	326	Disable	4-75
USPS 4CB/One Code/Intelligent Mail	592	Disable	4-75
UPU FICS Postal	611	Disable	4-76
2D Symbolologies			
PDF417	15	Enable	4-77
MicroPDF417	227	Disable	4-77
Code 128 Emulation	123	Disable	4-78
Data Matrix	292	Enable	4-79
Data Matrix Inverse	588	Inverse Autodetect	4-79
Decode Mirror Images (Data Matrix Only)	537	Auto	4-80
Maxicode	294	Disable	4-81
QR Code	293	Enable	4-81
QR Inverse	587	Regular	4-82
MicroQR	573	Enable	4-82
Aztec	574	Enable	4-83
Aztec Inverse	589	Inverse Autodetect	4-83
Han Xin	1167	Disable	4-84
Han Xin Inverse	1168	Regular	4-84

Table A-1 *Default Table (Continued)*

Parameter	Parameter Number (Hex)	Factory Default	Page Number
Symbology-Specific Security Levels			
Redundancy Level	78	1	4-85
Bi-directional Redundancy	67	Disable	4-87
Security Level	77	1	4-88
Intercharacter Gap Size	381	Normal	4-89

APPENDIX B ACCESSORIES

Overview

CS4070 accessories provide a variety of product support capabilities. Accessories include a micro USB cable, cradles, spare battery charger, wall mounts, and lanyard. See [Table B-1](#) for a full list of accessories and descriptions.

Accessories Summary

Table B-1 lists the accessories available for the CS4070.

Table B-1 CS4070 Accessories

Accessory	Part Number	Description	Page
Cradles and Battery Accessories			
1-slot terminal and spare battery charger	CHS5000-1000CR	Single-slot cradle for charging one CS4070 (with battery installed) and one spare battery simultaneously. Includes power supply and DC line cord.	B-3
8-slot terminal charger	CHS5000-8000CR	8-slot cradle for charging up to eight CS4070 devices simultaneously. Includes power supply and DC line cord.	B-5
8-slot battery charger	SAC5000-8000CR	8-slot battery charger for charging up to eight CS4070 batteries simultaneously. Includes power supply and DC line cord.	B-7
Replacement batteries	BTRY-CS40EAB00-04	One CS4070-SR battery.	N/A
	BTRY-CS40EAB00-0B	One CS4070-HC battery.	N/A
	BT10-CS40EAB00-04	10 CS4070-SR batteries.	N/A
	BT10-CS40EAB00-0B	10 CS4070-HC batteries.	N/A
Miscellaneous Accessories			
Lanyard (with clip)	21-102377-01	Clip with neck cord, used to wear the CS4070 around user's neck.	B-16
Wall mount bracket for 8-slot battery charger	KT-102376-01R	Wall mounts the 8-slot battery charger.	B-9
Wall mount bracket for 8-slot terminal charger	KT-102375-01R	Wall mounts the 8-slot terminal charger.	B-11
Bluetooth dongle	BT-CS1-0BR	Bluetooth to HID dongle.	B-14
Dongle cable	CBA-U21-S07ZAR	Replacement USB cable for dongle.	B-14

Single-Slot CS4070 Charging Cradle with Spare Battery Charger

The single-slot CS4070 charging cradle:

- Provides 5.1 VDC power for operating the device.
- Charges the CS4070 battery in the device.
- Charges one spare battery.

✓ **NOTE** Use only genuine Zebra batteries (p/n 82-83172-01) with CS4070 devices and charging accessories.

Use only an approved power supply 50-14000-147R output rated 12 Vdc and minimum 3.3 A with AC line cord 50-16000-182R. The power supply is certified to EN60950-1 with SELV outputs. Use of an alternative power supply invalidates any approval given to this device and may be dangerous.

To charge batteries in the single-slot cradle:

1. Connect the cradle to power.
2. To charge the battery in the device, insert the CS4070 into the device slot. To charge a spare battery, insert it in the spare battery charging well.

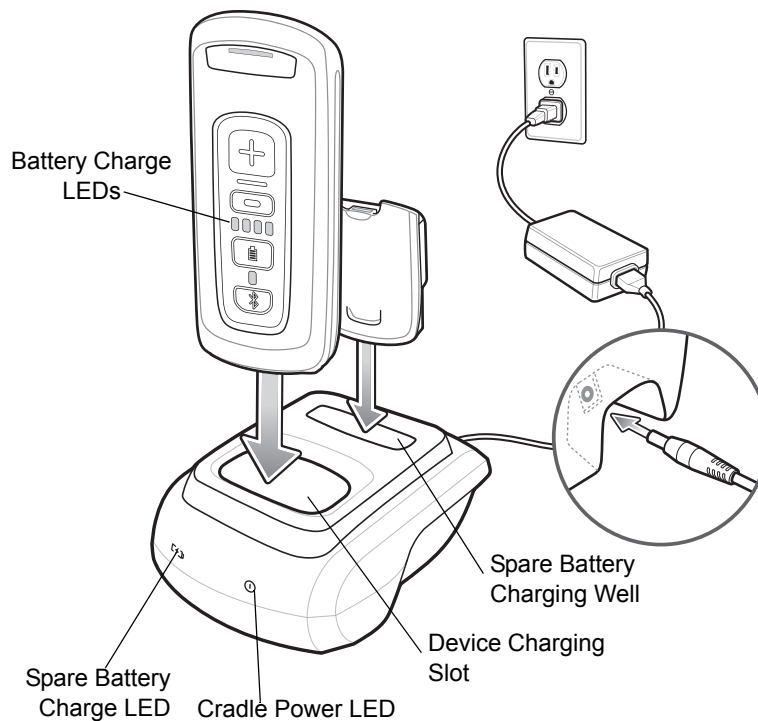

Figure B-1 Single-Slot Cradle Power Connection

Battery Charging Indications

The single-slot cradle charges the device battery and a spare battery simultaneously.

The device battery level LEDs indicate the status of the battery charging in the device. See [Table 2-1 on page 2-3](#) for charging status indications.

The spare battery charging LED on the cradle indicates the status of the spare battery charging in the cradle. See [Table B-2](#) for charging status indications.

The battery fully charges in approximately three hours. See [Charging Temperature on page 1-4](#) for charging temperature information.

Spare Battery Charging Indications

Table B-2 Spare Battery Charging Indications

Spare Battery LED (on cradle)	Indication
Solid Red	Spare battery is charging
Solid Green	Spare battery is fully charged
Blinking Red	Charging error
Off	No battery inserted
Cradle Power	
Solid Green	Power on
Off	Power off

Bluetooth Connectivity

When a CS4070 is inserted into a charging cradle, it maintains Bluetooth communication over the wireless network.

Eight-Slot CS4070 Charging Cradle

The eight-slot CS4070 charging cradle provides 5.1 VDC power for operating the device and charges the CS4070 battery in the device.

✓ **NOTE** Use only genuine Zebra batteries (p/n 82-83172-01) with CS4070 devices and charging accessories.

Use only an approved power supply KT-14000-148R output rated 12 Vdc and minimum 3.3 A with AC line cord 23844-00-00. The power supply is certified to EN60950-1 with SELV outputs. Use of an alternative power supply invalidates any approval given to this device and may be dangerous.

To charge batteries in the eight-slot charging cradle:

1. Connect the cradle to power.
2. To charge the device battery, insert the CS4070 into a device slot.

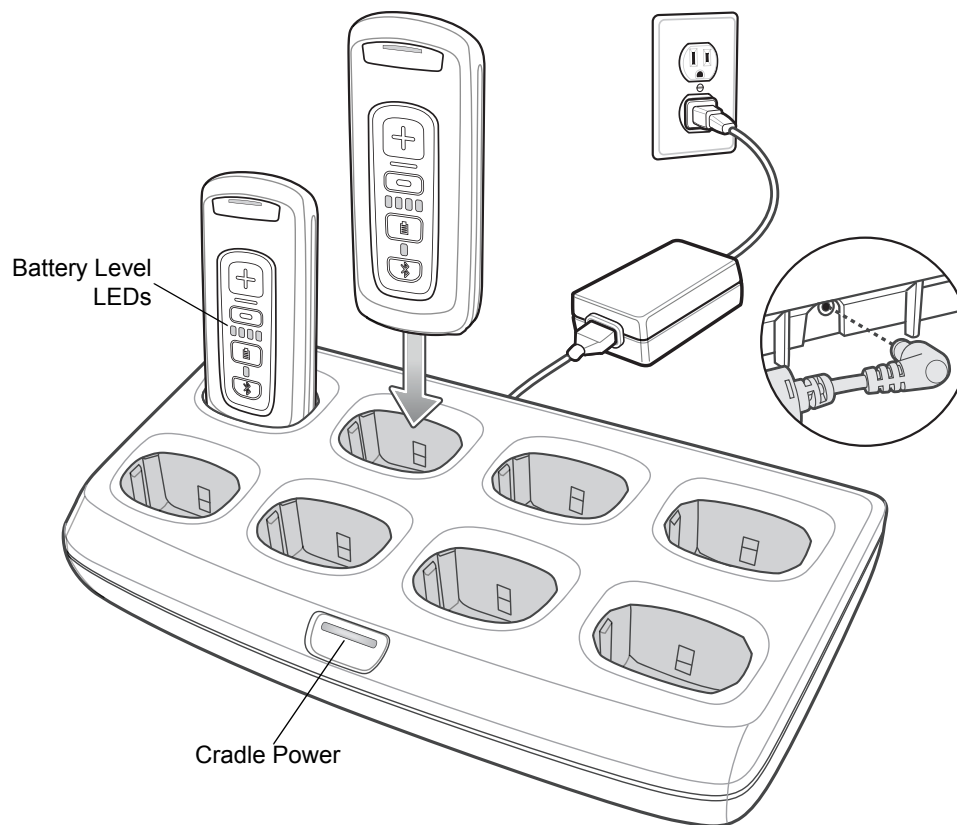

Figure B-2 Eight-Slot Cradle Power Connection

Battery Charging Indications

The eight-slot cradle charges up to eight CS4070 devices simultaneously.

The LEDs on each CS4070 indicate the charging status of the battery in the device. See [Table 2-1 on page 2-3](#) for status indications.

Batteries nominally take three hours to charge at ambient temperatures of 30° C or below. See [Charging Temperature on page 1-4](#) for charging temperature information.

Bluetooth Connectivity

When a CS4070 is inserted into a charging cradle, it maintains Bluetooth communication over the wireless network.

✓ **NOTE** CS4070 cradles do not support wired ethernet communication.

Eight-Slot Spare Battery Charger

This section describes how to use the eight-slot spare battery charger to charge up to eight spare batteries.

✓ **NOTE** Use only genuine Zebra batteries (p/n 82-83172-01) with CS4070 devices and charging accessories.

Use only an approved power supply KT-14000-148R output rated 12 Vdc and minimum 3.3 A with AC line cord 23844-00-00. The power supply is certified to EN60950-1 with SELV outputs. Use of an alternative power supply invalidates any approval given to this device and may be dangerous.

To charge spare batteries in the eight-slot spare battery charger:

1. Connect the power supply to the power port on the back of the charger as shown in [Figure B-3](#).

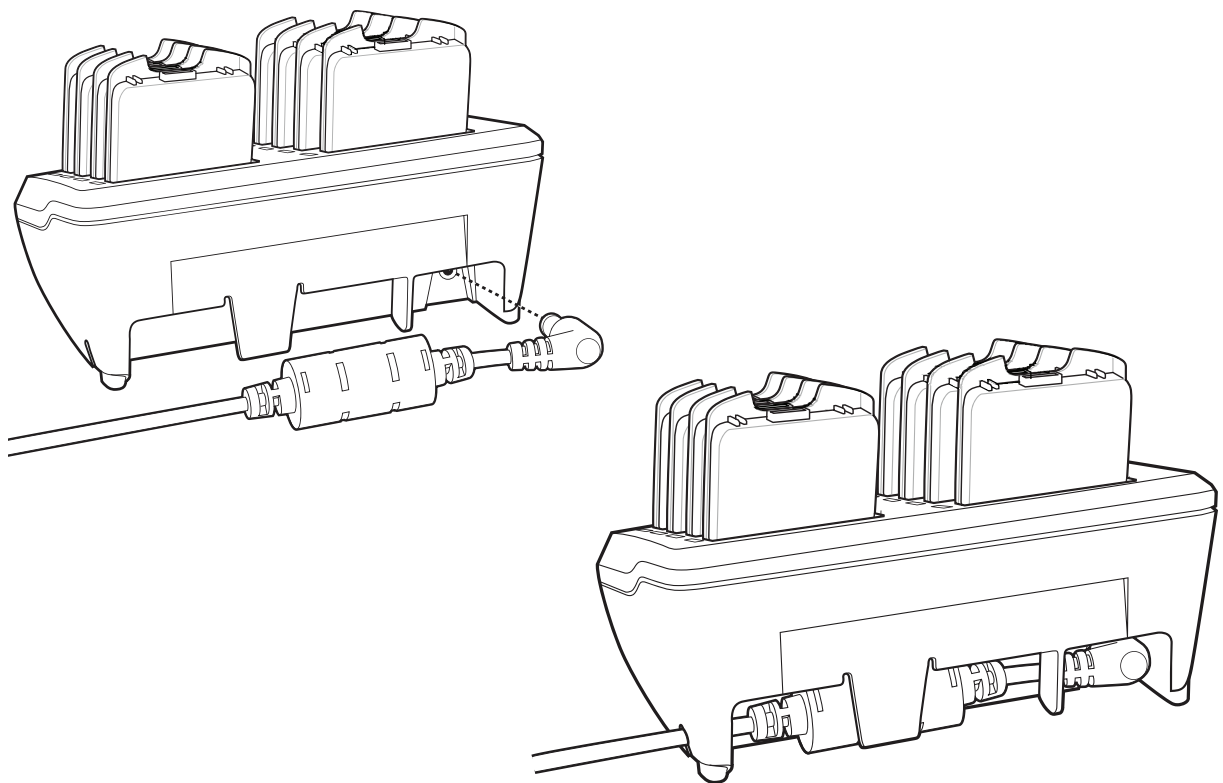

Figure B-3 *Connecting Power*

2. Connect the other end of the power supply to a power source.

3. Insert the spare battery into a spare battery charging well and gently press down on the battery to ensure proper contact.

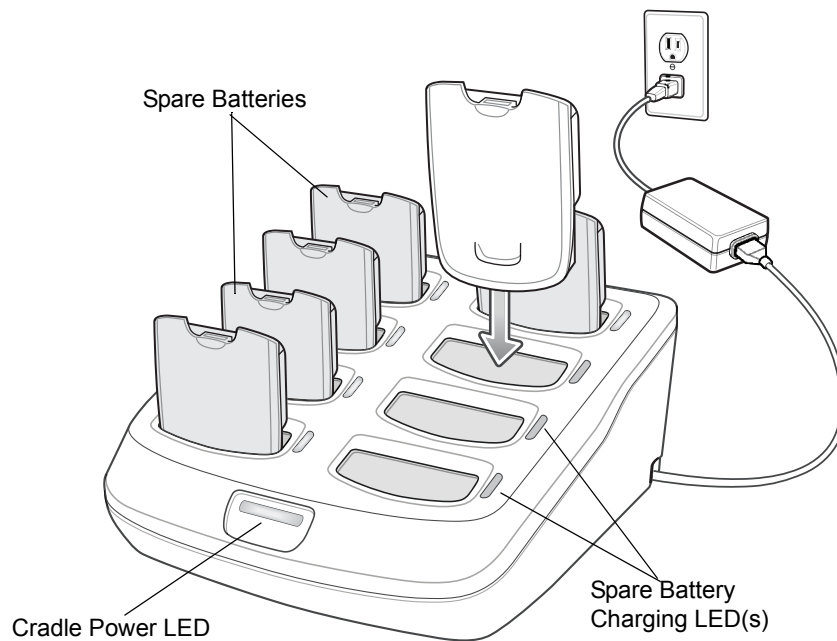

Figure B-4 Spare Battery Installation

Battery Charging Indications

An LED is provided for each battery charging well. See [Table B-3](#) for charging status indications. The battery fully charges in approximately three hours. See [Charging Temperature on page 1-4](#) for charging temperature information.

LED Indications

Table B-3 LED Indications

LED	Indication
Solid Green	Spare battery charging is complete
Solid Red	Spare battery is charging
Blinking Red	Charge error; check placement of spare battery
Off	No battery inserted

Wall Mount Brackets

Two optional wall mount brackets are available for mounting a CS4070 battery charger and/or a spare battery charger to a wall.

- The KT-102376-01R wall mount bracket is used to mount one SAC5000-8000CR (eight-slot) battery charger.
- The KT-102375-01R wall mount bracket is used to mount one CHS5000-8000CR (eight-slot) CS4070 charger, or two SAC5000-8000CR (eight-slot) battery chargers.

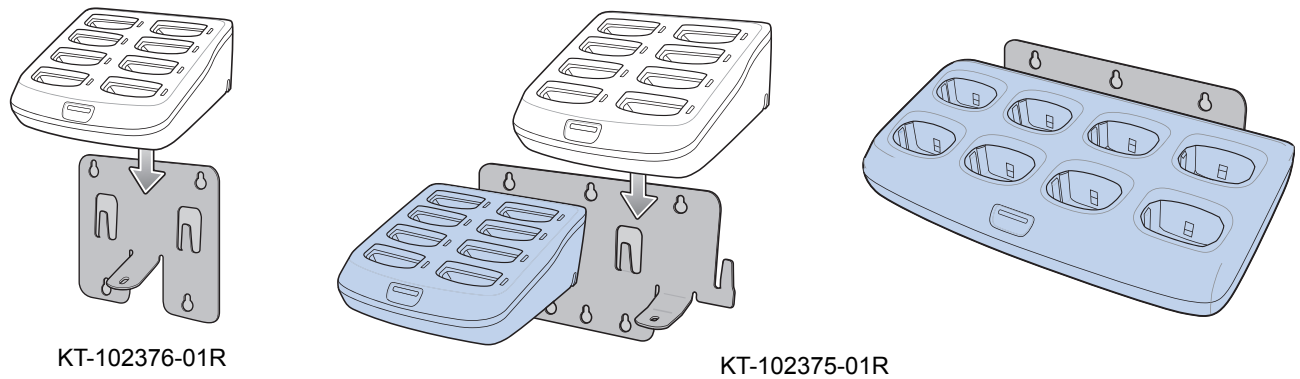

Figure B-5 Wall Mount Brackets

KT-102376-01R Bracket

The KT-102376-01R bracket mounts one SAC5000-8000CR (eight-slot) spare battery charger to a wall. Use the wall mount bracket as a template to mark the locations of the four mounting screws.

Included Hardware

- One KT-102376-01R Mounting Bracket
- One black .5" Phillips round head, thread cutting screw.

✓ **NOTE** Use the .5" Phillips round head screw supplied in mounting bracket kit to attach the eight-slot spare battery charger to the mounting bracket. This screw is not intended for mounting the bracket on a wall.

For safety and stability, it is recommended that you use the appropriate wall mounting hardware for installation. For safe mounting, it is essential to use wall anchors appropriate to the wall type (i.e. plaster, drywall, concrete, etc.). Mount to wood studs whenever possible.

The wall mount bracket mounting slots are designed for a fastener with a #8 pan head.

Mounting Instructions

- ✓ **NOTE** Connect an approved power supply to the cradle prior to attaching the cradle to the wall mount bracket. See [Eight-Slot Spare Battery Charger on page B-7](#) for power supply information.

1. Slide the two bracket mounting tabs into the receptacles on the bottom of the cradle as shown. Ensure the screw hole in the bracket flange aligns with the screw hole in the cradle.

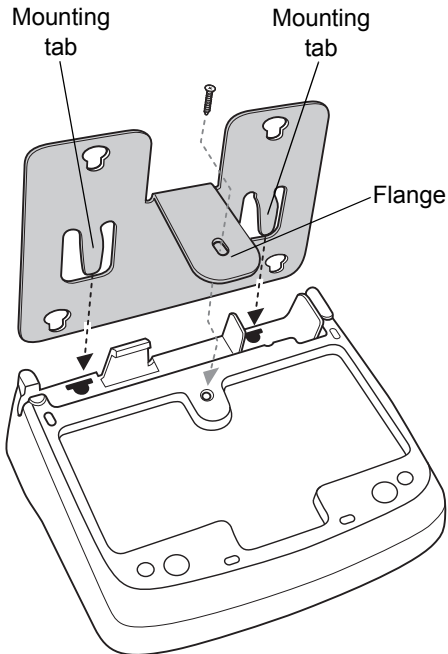

Figure B-6 *Insert Bracket into Cradle*

2. Screw the .5" Phillips screw (supplied) into the bracket flange and tighten until the cradle is securely attached to the bracket.

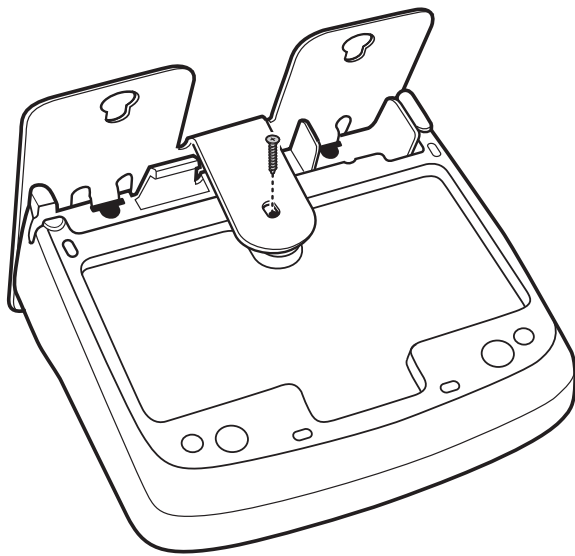

Figure B-7 *Attach Flange with Screw*

- Use four screws to mount the bracket to a wall. Ensure to use additional wall mounting hardware, as needed, for safe mounting to the wall type.

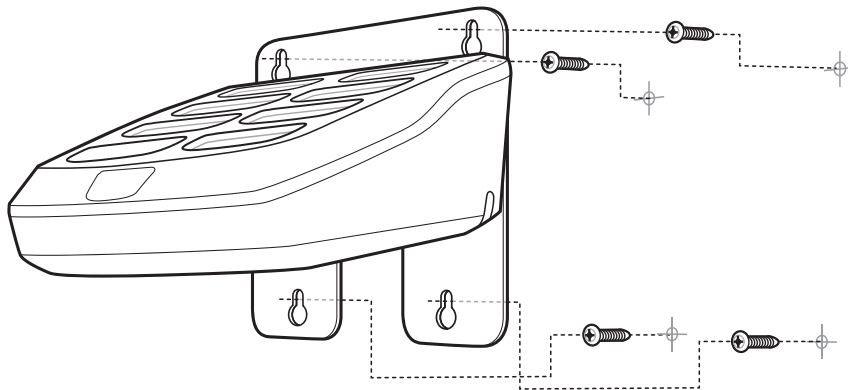

Figure B-8 *Mount to Wall*

KT-102375-01R Bracket

The KT-102375-01R bracket mounts one CHS5000-8000CR (eight-slot) CS4070 charger, or two SAC5000-8000CR (eight-slot) spare battery chargers to a wall. Use the wall mount brackets as a template to mark the locations of the four mounting screws.

Included Hardware

- Two KT-102375-01R Mounting Bracket
- One black .5" Phillips round head, thread cutting screw.

✓ **NOTE** Use the .5" Phillips round head screw supplied in mounting bracket kit to attach the eight-slot spare battery charger to the mounting bracket. This screw is not intended for mounting the bracket on a wall.

For safety and stability, it is recommended that you use the appropriate wall mounting hardware for installation. For safe mounting, it is essential to use wall anchors appropriate to the wall type (i.e. plaster, drywall, concrete, etc.). Mount to wood studs whenever possible.

The wall mount bracket mounting slots are designed for a fastener with a #8 pan head.

Mounting Instructions

- ✓ **NOTE** Connect an approved power supply to the cradle(s) prior to attaching the cradle(s) to the wall mount bracket. See [Eight-Slot Spare Battery Charger on page B-7](#) and [Eight-Slot CS4070 Charging Cradle on page B-5](#) for power supply information.

1. When mounting one eight-slot CS4070 battery charger (CHS5000-8000CR), slide the four bracket mounting tabs into the receptacles on the bottom of the charger as shown in [Figure B-9](#). Ensure the screw holes in the bracket flanges align with the screw holes in the cradle.

When mounting two eight-slot battery chargers (SAC5000-8000CR), slide two bracket mounting tabs into each battery charger as shown in [Figure B-10](#).

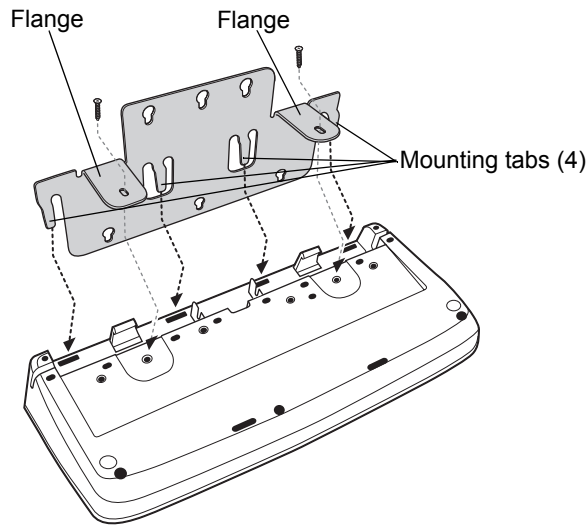

Figure B-9 Insert Bracket into CHS5000-8000CR Cradle

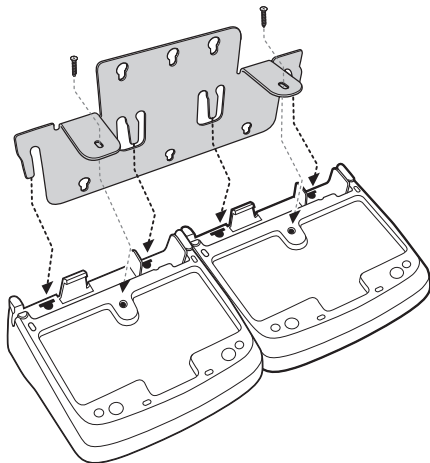

Figure B-10 Insert Bracket into SAC5000-8000CR Cradle

- Screw the bracket to the cradle(s).
CHS5000-8000CR: Screw the two supplied .5" Phillips screws into the two bracket flanges and tighten until the cradle is securely attached to the bracket (as shown in drawing A, [Figure B-11](#)).

SAC5000-8000CR: Screw one supplied .5" Phillips screw in each flange and tighten one flange to each cradle (as shown in drawing B, [Figure B-11](#)).

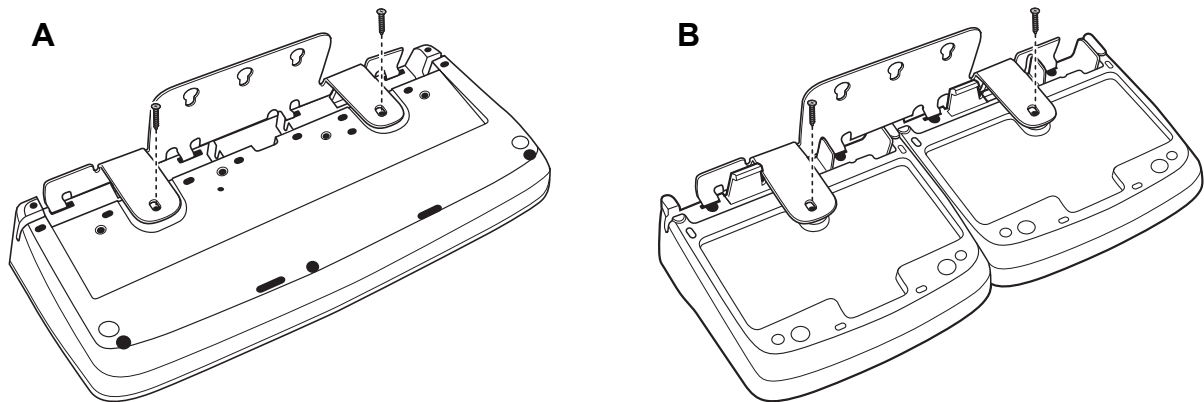

Figure B-11 *Screw the Bracket to the Cradle*

- Use six screws (not supplied) to mount the bracket(s) to a wall.

✓ **NOTE** Ensure to use additional wall mounting hardware, as needed, for safe mounting to the wall type.

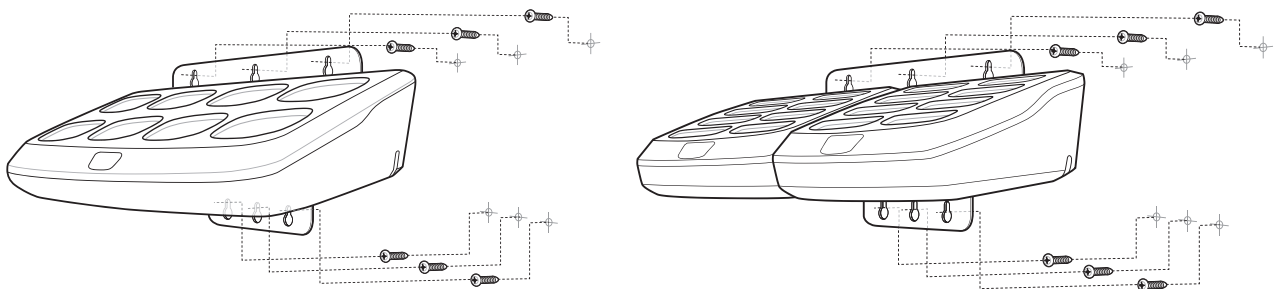

Figure B-12 *Mount Bracket(s)*

Bluetooth to USB HID Dongle

The Bluetooth to USB HID dongle pairs the scanner with an HID host simply by scanning the bar code on the dongle. The dongle is available for the CS4070HC only, and pairs to a single scanner at a time.

The dongle has the following features:

- USB bus powered
- Power consumption less than 100 mA
- Wall or surface mounting features
- Pairing bar code printed on label on front of device, visible when mounted
- IP40 sealing
- USB connection:
 - RJ45 connector
 - Standard Zebra USB cables
 - USB HID keyboard profile (US English only)
 - No drivers required for connection to host PC, Windows, and Linux 32 and 64-bit systems
- Bluetooth:
 - Class 1 radio
 - Bluetooth stack version 2.1 + EDR
 - Blue LED for Bluetooth status (Off = not paired, solid = paired)
 - Allows only a single BT connection
 - HID Bluetooth profiles
 - No Bluetooth pings or other transmissions when not paired

Pairing to a USB HID Device

To use the dongle to pair to a USB HID device:

1. If desired, mount the dongle to a wall using #3 wood screws with pan head (2.52 mm max thread diameter), or M2.5 machine screws with socket or pan head (2.5 mm max thread diameter) (not provided).

✓ **NOTE** Ensure to use additional wall mounting hardware, as needed, for safe mounting to the wall type.

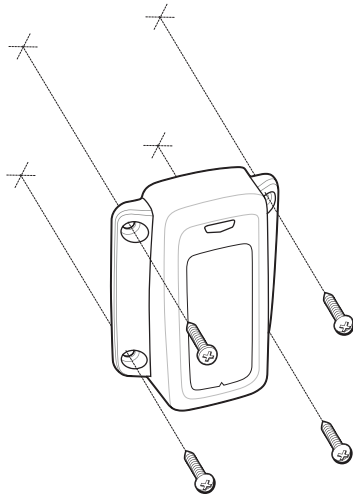

Figure B-13 Wall Mounting Dongle

2. Connect the RJ45 cable to the dongle RJ45 port, and the other end of the cable to a USB port on the HID device.

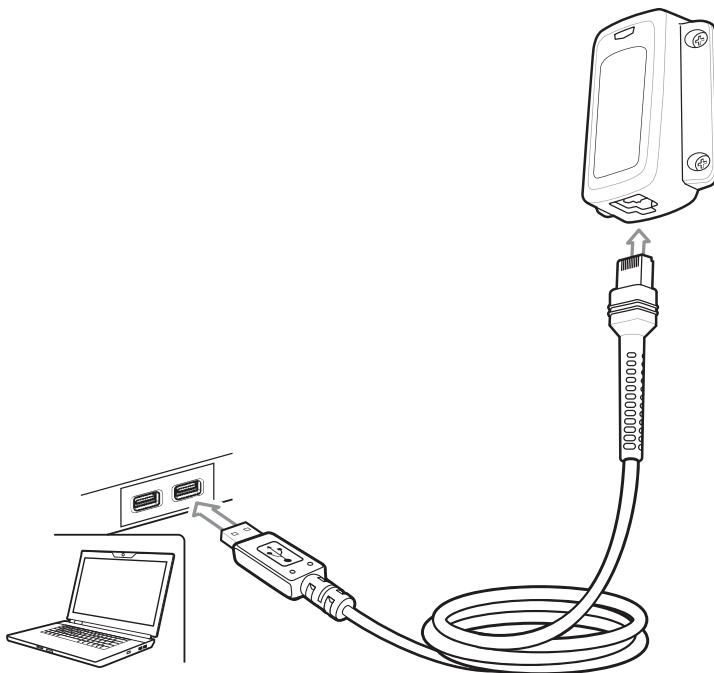

Figure B-14 Connecting Dongle to HID Device

3. Using the CS4070, scan the bar code on the dongle to pair the scanner with the HID device.

Lanyard with Clip

For ease of use, attach the CS4070 to the lanyard with clip in order to wear the device around the neck as shown in [Figure B-15](#).



Figure B-15 *Wearing Lanyard*

Attaching and Removing the Lanyard

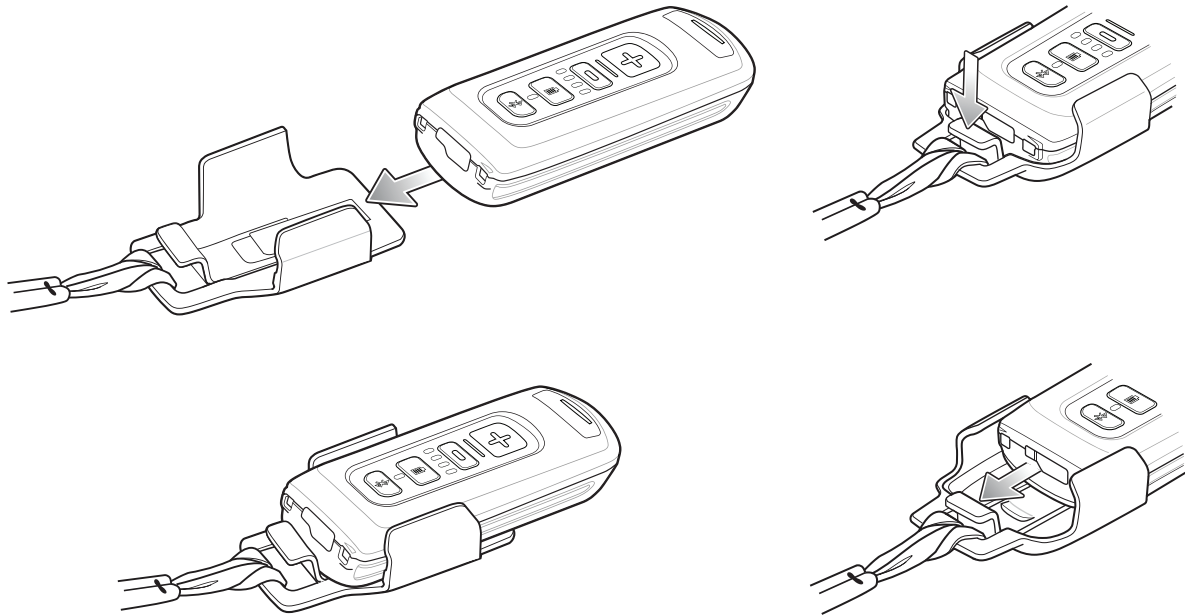

Figure B-16 *Attaching and Removing the Lanyard*

APPENDIX C BLUETOOTH CONNECTION EXAMPLES

Overview

Pairing the CS4070 with a host device typically requires holding the Bluetooth button to place the scanner in discoverable mode, then entering a pairing PIN. To enter the PIN on the CS4070, use the [PIN Entry Bar Codes on page C-9](#). For the host device, use the data entry method required for that device to enter the PIN.

This section provides the following connection examples:

- [iPad Pairing Example](#)
- [Android Pairing Example on page C-3](#)
- [Windows 7 Pairing Example on page C-5](#)
- [Windows 8 Pairing Example on page C-7](#)

iPad Pairing Example

1. Press the scan button (+) to wake the scanner.
2. Scan the **Bluetooth HID Profile** bar code on [page 3-8](#).
3. Press and hold the Bluetooth button for five seconds. The scanner beeps and the Bluetooth button blinks quickly to indicate that the scanner is discoverable by the host.
4. On the iPad, tap the **Settings** icon.
5. Tap **General** from the list of options that appears.
6. Tap **Bluetooth**. If Bluetooth is not enabled, swipe to enable it. The CS4070 appears in the **Devices** list, indicated by its model name.

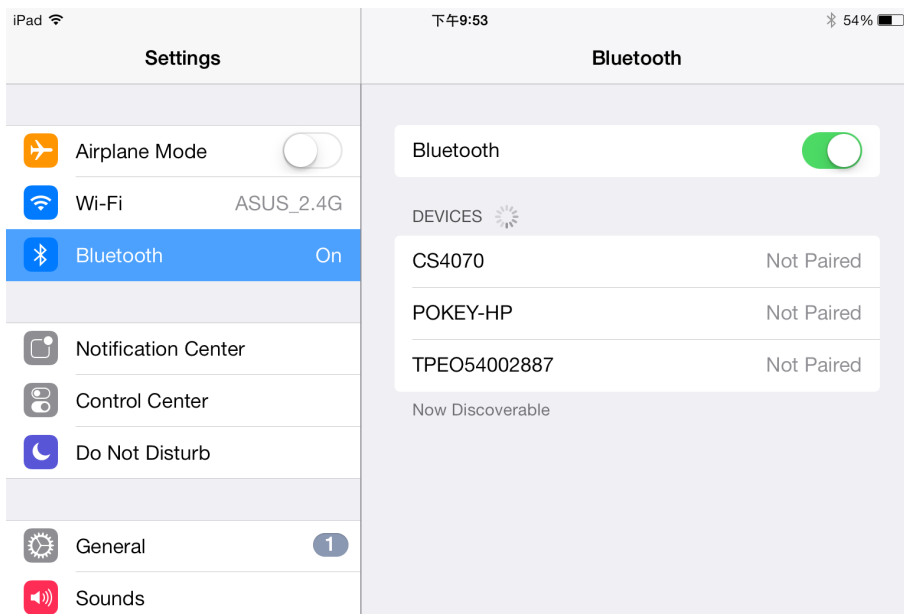

Figure C-1 Bluetooth Devices

7. Select the CS4070 from the list. In HID mode, the CS4070 doesn't have to scan a PIN code to authenticate pairing.

The scanner beeps to indicate it has paired with the iPad, and the iPad displays **Connected** next to the CS4070 device name.



Figure C-2 CS4070 Connected

Android Pairing Example

✓ **NOTE** To avoid data loss, set [KeystrokeDelay on page 1-10](#) to 70 ms before pairing with the Android.

1. Press the scan button (+) to wake the scanner.
2. Press and hold the Bluetooth button for five seconds. The scanner beeps and the Bluetooth button blinks quickly to indicate that the scanner is discoverable by the host.
3. On the Samsung Galaxy Tab 2, tap the **Settings** icon.
4. Tap **Bluetooth**. If Bluetooth is not enabled, swipe to enable it. The CS4070 appears in the **Available devices** list, indicated by its model name and serial number.

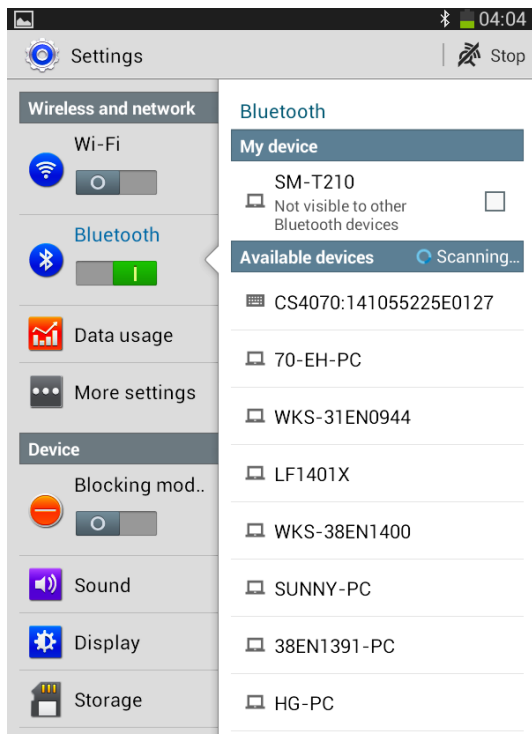

Figure C-3 Samsung Available Devices List

5. Select the CS4070 from the list. A window prompts for a PIN generated by the Samsung Galaxy Tab 2.

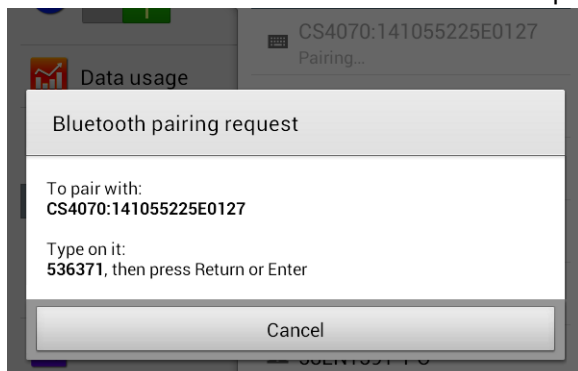

Figure C-4 Samsung Pairing Request Window

- With the CS4070, scan the PIN using the *PIN Entry Bar Codes on page C-9* and scan **Enter**.

The scanner beeps to indicate it has paired with the Samsung Galaxy Tab 2, and the Samsung Galaxy Tab 2 displays **Connected** below the CS4070 device name.

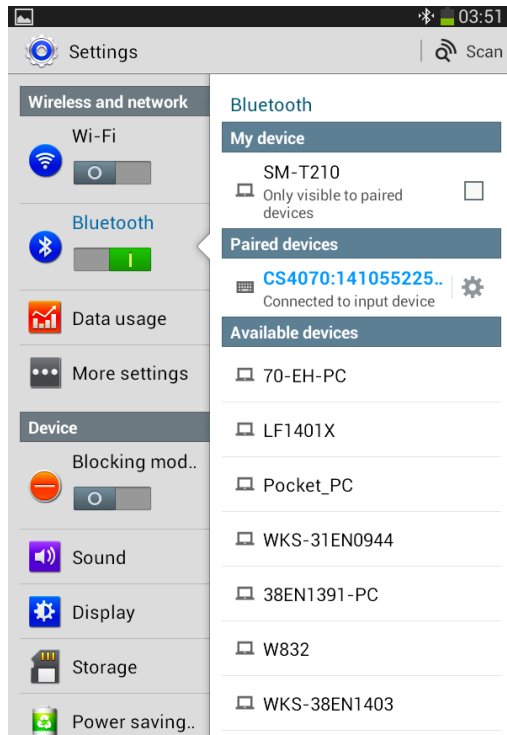

Figure C-5 *Device Connected*

Accessing the Android Phone Keyboard

To activate the **Choose Input Method** notification, multiple keyboards must be available. To accomplish this:

- Select **Settings > Language and Input**.
- Under **Keyboard & Input Methods**, select the box next to another keyboard, such as the **iWnn IME Emoji Input** or **Google Pinyin Input**.
- Optionally, if no other keyboards are available, install a third party keyboard from the Play Store such as the **NullKeyboard** or **AnySoftKeyboard**. In **Language and Input** settings, select the box next to the installed third party keyboard. Select **OK** on the warning message window.
- Open any text input box. A **Choose Input Method** notification appears in the notification bar (top left).
- Tap the notification (not **Select Keyboard Layout**).
- Select **Off** for the **Hardware** on/off slider.
- Use the radio buttons to select the software keyboard.
- Tap the **Back** button. The on-screen keyboard appears, and the Bluetooth keyboard is still functional.

Windows 7 Pairing Example

1. Press the scan button (+) to wake the scanner.
2. Press and hold the Bluetooth button for five seconds. The scanner beeps and the Bluetooth button blinks quickly to indicate that the scanner is discoverable by the host.
3. On the HP NB (WIN7 OS), tap the **Start** menu, then **Devices and printers**.
4. Tap **Add a device**. Ensure the CS4070 is discoverable in the **Devices** list, indicated by its model name and serial number.

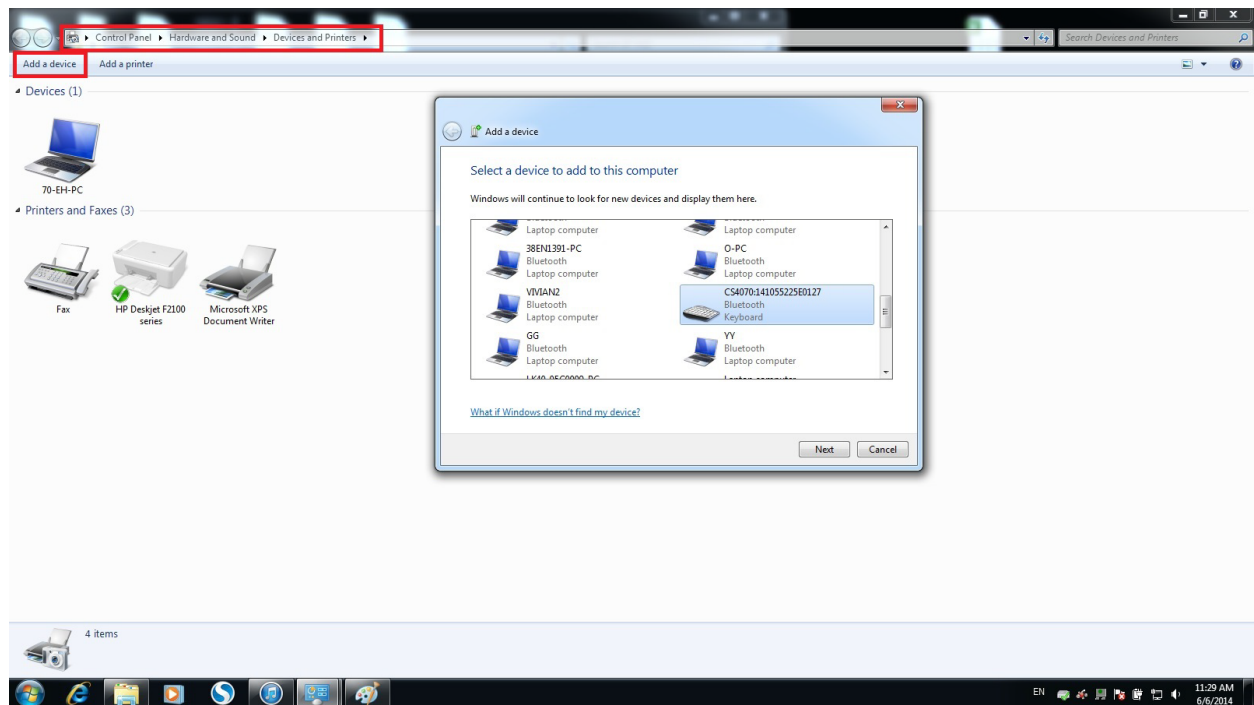

Figure C-6 Device List

5. Select the CS4070 from the list. A window prompts for a PIN generated by the HP NB (WIN7 OS).

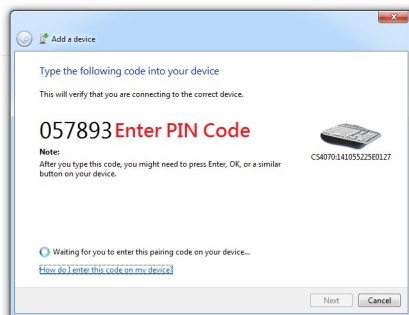

Figure C-7 PIN Prompt

6. With the CS4070, scan the PIN using the *PIN Entry Bar Codes on page C-9* and scan **Enter**. The scanner beeps to indicate it has paired with the HP NB (WIN7 OS), and the HP NB displays a success window.

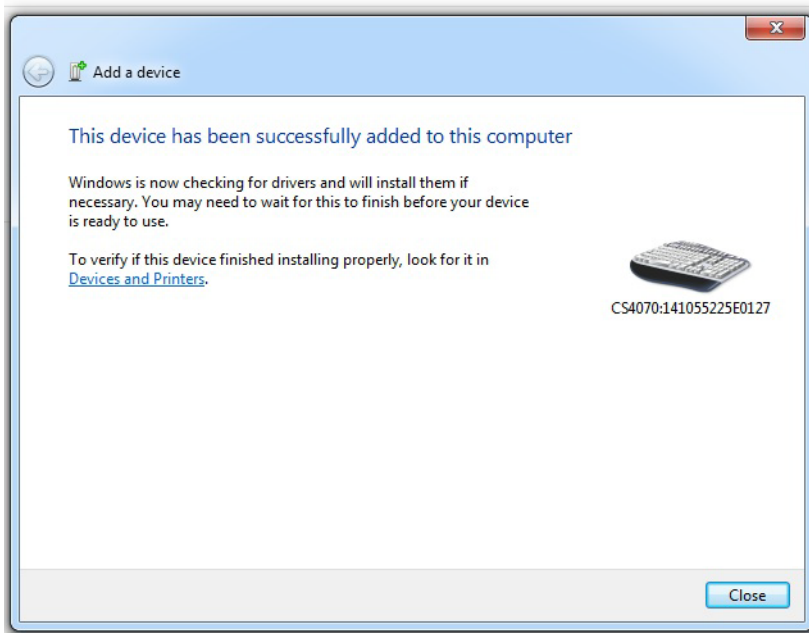

Figure C-8 CS4070 Connected

7. Ensure the CS4070 device icon displays in devices list.

Windows 8 Pairing Example

1. Press the scan button (+) to wake the scanner.
2. Press and hold the Bluetooth button for five seconds. The scanner beeps and the Bluetooth button blinks quickly to indicate that the scanner is discoverable by the host.
3. On the Lenovo ThinkPad Tablet, slide the right side of screen to invoke the **Start** menu, and tap the **Settings** icon.
4. Tap **Change PC Settings** to invoke the PC settings list, and tap **PC and devices**.
5. Tap **Bluetooth**. If Bluetooth is not enabled, swipe to enable it. The CS4070 appears in the **Devices** list, indicated by its model name.
6. Select the CS4070 from the list. A window prompts for a PIN generated by the Lenovo ThinkPad Tablet.

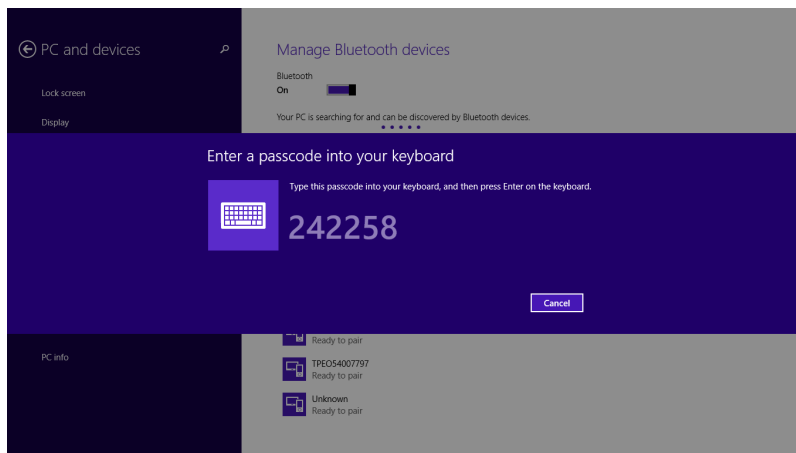

Figure C-9 ThinkPad Pairing Request Window

7. With the CS4070, scan the PIN using the *PIN Entry Bar Codes on page C-9* and scan **Enter**. The scanner beeps to indicate it has paired with the Lenovo ThinkPad Tablet, and the Lenovo ThinkPad Tablet displays Connected below the CS4070 device name.

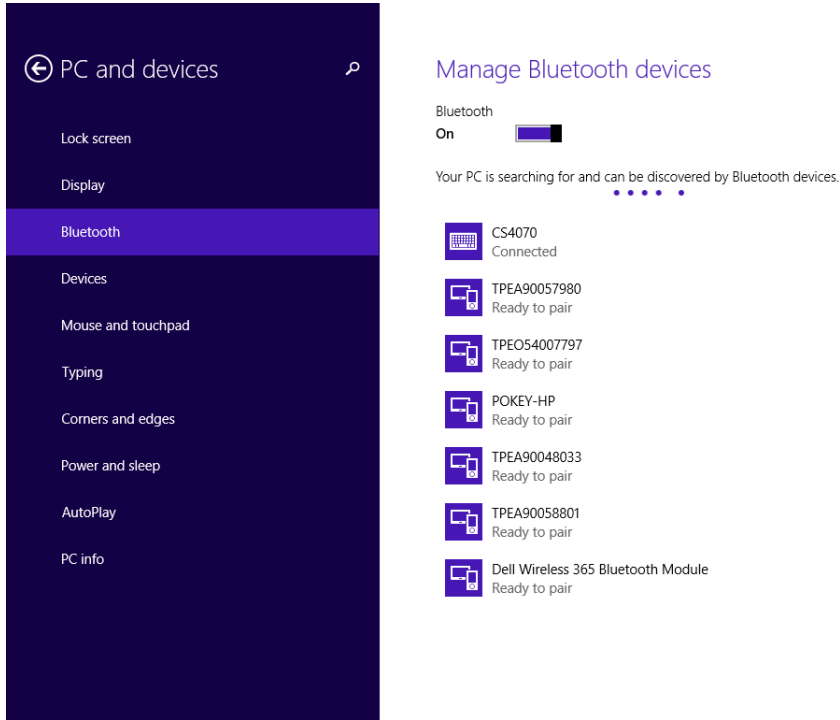

Figure C-10 CS4070 Connected

PIN Entry Bar Codes

Use the following bar codes for PIN entry for Bluetooth connection.



0



1



2

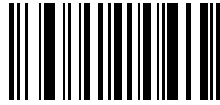

3

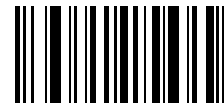

4

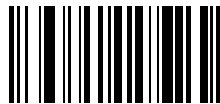

5

PIN Entry Bar Codes (continued)



6

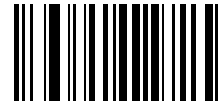

7



8

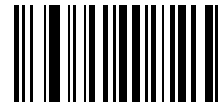

9



Enter



Cancel

APPENDIX D PROGRAMMING REFERENCE

Code Type IDs

Table D-1 *Bar Code Type Identifiers*

SDL Code Type ID	Bar Code Type
1	Code 39
2	Codabar
3	Code 128
4	Discrete (Standard) 2 of 5
5	IATA
6	Interleaved 2 of 5
7	Code 93
8	UPC-A
9	UPC-E0
10	EAN-8
11	EAN-13
12	Code 11
13	Code 49
14	MSI
15	EAN-128
16	UPC-E1
17	PDF417

Table D-1 *Bar Code Type Identifiers (Continued)*

SDL Code Type ID	Bar Code Type
18	Code 16K
19	Code 39 Full ASCII
20	UPC-D
21	Code 39 Trioptic
22	Bookland
23	Coupon Code
24	NW-7
25	ISBT-128
26	MicroPDF
27	DataMatrix
28	QR Code
29	MicroPDF CCA
30	PostNet US
31	Planet Code
32	Code 32
33	ISBT-128 Con
34	Japan Postal
35	Australian Postal
36	Dutch Postal
37	MaxiCode
38	Canadian Postal
39	UK Postal
40	Macro PDF
41	Macro QR
44	MicroQR
45	Aztec
46	Aztec Rune
48	GS1 DataBar-14
49	GS1 DataBar Limited
50	GS1 DataBar Expanded
52	USPS 4CB

Table D-1 Bar Code Type Identifiers (Continued)

SDL Code Type ID	Bar Code Type
53	UPU 4State
54	ISSN
55	Scanlet
56	CueCode
57	Matrix 2 of 5
72	UPC-A + 2 Supplemental
73	UPC-E0 + 2 Supplemental
74	EAN-8 + 2 Supplemental
75	EAN-13 + 2 Supplemental
80	UPC-E1 + 2 Supplemental
81	CCA EAN-128
82	CCA EAN-13
83	CCA EAN-8
84	CCA GS1 DataBar Expanded
85	CCA GS1 DataBar Limited
86	CCA GS1 DataBar-14
87	CCA UPC-A
88	CCA UPC-E
89	CCC EAN-128
90	TLC-39
97	CCB EAN-128
98	CCB EAN-13
99	CCB EAN-8
100	CCB GS1 DataBar Expanded
101	CCB GS1 DataBar Limited
102	CCB GS1 DataBar-14
103	CCB UPC-A
104	CCB UPC-E
105	Signature Capture
114	Chinese 2 of 5
115	Korean 3 of 5

Table D-1 Bar Code Type Identifiers (Continued)

SDL Code Type ID	Bar Code Type
136	UPC-A + 5 supplemental
137	UPC-E0 + 5 supplemental
138	EAN-8 + 5 supplemental
139	EAN-13 + 5 supplemental
144	UPC-E1 + 5 Supplemental
154	Macro MicroPDF
180	GS1 Databar Coupon
183	Han Xin

Symbol Code Identifiers

Table D-2 Symbol Code Characters

Code Character	Code Type
A	UPC-A, UPC-E, UPC-E1, EAN-8, EAN-13
B	Code 39, Code 32
C	Codabar
D	Code 128, ISBT 128, ISBT 128 Concatenated
E	Code 93
F	Interleaved 2 of 5
G	Discrete 2 of 5, or Discrete 2 of 5 IATA
H	Code 11
J	MSI
K	GS1-128
L	Bookland EAN
M	Trioptic Code 39
N	Coupon Code
R	GS1 DataBar Family
S	Matrix 2 of 5
T	UCC Composite, TLC 39
U	Chinese 2 of 5

Table D-2 *Symbol Code Characters (Continued)*

Code Character	Code Type
V	Korean 3 of 5
X	ISSN EAN, PDF417, Macro PDF417, MicroPDF417
z	Aztec, Aztec Rune
P00	Data Matrix
P01	QR Code, MicroQR
P02	Maxicode
P03	US Postnet
P04	US Planet
P05	Japan Postal
P06	UK Postal
P08	Netherlands KIX Code
P09	Australia Post
P0A	USPS 4CB/One Code/Intelligent Mail
P0B	UPU FICS Postal
P0H	Han Xin
P0X	Signature Capture

AIM Code Identifiers

Each AIM Code Identifier contains the three-character string **Jcm** where:

- J = Flag Character (ASCII 93)
- c = Code Character (see [Table D-3](#))
- m = Modifier Character (see [Table D-4](#))

Table D-3 *Aim Code Characters*

Code Character	Code Type
A	Code 39, Code 39 Full ASCII, Code 32
C	Code 128, ISBT 128, ISBT 128 Concatenated, GS1-128, Coupon (Code 128 portion)
d	Data Matrix
E	UPC/EAN, Coupon (UPC portion)
e	GS1 DataBar Family
F	Codabar
G	Code 93
H	Code 11
h	Han Xin
I	Interleaved 2 of 5
L	PDF417, Macro PDF417, MicroPDF417
L2	TLC 39
M	MSI
Q	QR Code, MicroQR
S	Discrete 2 of 5, IATA 2 of 5
U	Maxicode
z	Aztec, Aztec Rune
X	Bookland EAN, ISSN EAN, Trioptic Code 39, Chinese 2 of 5, Matrix 2 of 5, Korean 3 of 5, US Postnet, US Planet, UK Postal, Japan Postal, Australia Post, Netherlands KIX Code, USPS 4CB/One Code/Intelligent Mail, UPU FICS Postal, Signature Capture

The modifier character is the sum of the applicable option values based on [Table D-4](#).

Table D-4 *Modifier Characters*

Code Type	Option Value	Option
Code 39	0	No check character or Full ASCII processing.
	1	Reader has checked one check character.
	3	Reader has checked and stripped check character.
	4	Reader has performed Full ASCII character conversion.
	5	Reader has performed Full ASCII character conversion and checked one check character.
	7	Reader has performed Full ASCII character conversion and checked and stripped check character.
	Example: A Full ASCII bar code with check character W, A+I+MI+DW , is transmitted as JA7AIMID where $7 = (3+4)$.	
Trioptic Code 39	0	No option specified at this time. Always transmit 0.
	Example: A Trioptic bar code 412356 is transmitted as JX0412356	
Code 128	0	Standard data packet, no Function code 1 in first symbol position.
	1	Function code 1 in first symbol character position.
	2	Function code 1 in second symbol character position.
	Example: A Code (EAN) 128 bar code with Function 1 character ^{FNC1} in the first position, AIMID is transmitted as JC1AIMID	
I 2 of 5	0	No check digit processing.
	1	Reader has validated check digit.
	3	Reader has validated and stripped check digit.
	Example: An I 2 of 5 bar code without check digit, 4123, is transmitted as Ji04123	
Codabar	0	No check digit processing.
	1	Reader has checked check digit.
	3	Reader has stripped check digit before transmission.
	Example: A Codabar bar code without check digit, 4123, is transmitted as JF04123	
Code 93	0	No options specified at this time. Always transmit 0.
	Example: A Code 93 bar code 012345678905 is transmitted as JG0012345678905	
MSI	0	Check digits are sent.
	1	No check digit is sent.
	Example: An MSI bar code 4123, with a single check digit checked, is transmitted as JM14123	

Table D-4 Modifier Characters (Continued)

Code Type	Option Value	Option
D 2 of 5	0	No options specified at this time. Always transmit 0.
	Example: A D 2 of 5 bar code 4123, is transmitted as JS04123	
UPC/EAN	0	Standard data packet in full EAN format, i.e. 13 digits for UPC-A, UPC-E, and EAN-13 (not including supplemental data).
	1	Two digit supplemental data only.
	2	Five digit supplemental data only.
	3	Combined data packet comprising 13 digits from EAN-13, UPC-A or UPC-E symbol and 2 or 5 digits from supplemental symbol.
	4	EAN-8 data packet.
	Example: A UPC-A bar code 012345678905 is transmitted as JE00012345678905	
Bookland EAN	0	No options specified at this time. Always transmit 0.
	Example: A Bookland EAN bar code 123456789X is transmitted as JX0123456789X	
ISSN EAN	0	No options specified at this time. Always transmit 0.
	Example: An ISSN EAN bar code 123456789X is transmitted as JX0123456789X	
Code 11	0	Single check digit
	1	Two check digits
	3	Check characters validated but not transmitted.
GS1 DataBar Family		No option specified at this time. Always transmit 0. GS1 DataBar-14 and GS1 DataBar Limited transmit with an Application Identifier "01". Note: In GS1-128 emulation mode, GS1 DataBar is transmitted using Code 128 rules (i.e., Jc1).
	Example: A GS1 DataBar-14 bar code 0110012345678902 is transmitted as Je00110012345678902 .	
EAN.UCC Composites (GS1 DataBar, GS1-128, 2D portion of UPC composite)		Native mode transmission. Note: UPC portion of composite is transmitted using UPC rules.
	0	Standard data packet.
	1	Data packet containing the data following an encoded symbol separator character.
	2	Data packet containing the data following an escape mechanism character. The data packet does not support the ECI protocol.
	3	Data packet containing the data following an escape mechanism character. The data packet supports the ECI protocol.
		GS1-128 emulation Note: UPC portion of composite is transmitted using UPC rules.
	1	Data packet is a GS1-128 symbol (i.e., data is preceded with Jc1).

Table D-4 Modifier Characters (Continued)

Code Type	Option Value	Option
PDF417, MicroPDF417	0	Reader set to conform to protocol defined in 1994 PDF417 symbology specifications. Note: When this option is transmitted, the receiver cannot reliably determine whether ECIs have been invoked or whether data byte 92 _{DEC} has been doubled in transmission.
	1	Reader set to follow the ECI protocol (Extended Channel Interpretation). All data characters 92 _{DEC} are doubled.
	2	Reader set for Basic Channel operation (no escape character transmission protocol). Data characters 92 _{DEC} are not doubled. Note: When decoders are set to this mode, unbuffered Macro symbols and symbols requiring the decoder to convey ECI escape sequences cannot be transmitted.
	3	The bar code contains a GS1-128 symbol, and the first codeword is 903-907, 912, 914, 915.
	4	The bar code contains a GS1-128 symbol, and the first codeword is in the range 908-909.
	5	The bar code contains a GS1-128 symbol, and the first codeword is in the range 910-911.
	Example: A PDF417 bar code ABCD, with no transmission protocol enabled, is transmitted as]L2ABCD.	
Data Matrix	0	ECC 000-140, not supported.
	1	ECC 200.
	2	ECC 200, FNC1 in first or fifth position.
	3	ECC 200, FNC1 in second or sixth position.
	4	ECC 200, ECI protocol implemented.
	5	ECC 200, FNC1 in first or fifth position, ECI protocol implemented.
	6	ECC 200, FNC1 in second or sixth position, ECI protocol implemented.
MaxiCode	0	Symbol in Mode 4 or 5.
	1	Symbol in Mode 2 or 3.
	2	Symbol in Mode 4 or 5, ECI protocol implemented.
	3	Symbol in Mode 2 or 3, ECI protocol implemented in secondary message.

Table D-4 *Modifier Characters (Continued)*

Code Type	Option Value	Option
QR Code	0	Model 1 symbol.
	1	Model 2 / MicroQR symbol, ECI protocol not implemented.
	2	Model 2 symbol, ECI protocol implemented.
	3	Model 2 symbol, ECI protocol not implemented, FNC1 implied in first position.
	4	Model 2 symbol, ECI protocol implemented, FNC1 implied in first position.
	5	Model 2 symbol, ECI protocol not implemented, FNC1 implied in second position.
	6	Model 2 symbol, ECI protocol implemented, FNC1 implied in second position.
Aztec	0	Aztec symbol.
	C	Aztec Rune symbol.
Han Xin	0	Generic data, no special features are set. The transmitted data does not follow the AIM ECI protocol.
	1	ECI protocol enabled. There is at least one ECI mode encoded. Transmitted data must follow the AIM ECI protocol.

GS1-128 (formerly UCC/EAN-128)

GS1-128 is a convention for printing data fields with standard Code 128 bar code symbols. GS1-128 symbols are distinguished by a leading FNC 1 character as the first or second character in the symbol. Other FNC 1 characters are used to delineate fields.

When GS1-128 symbols are read, they are transmitted after special formatting strips off the leading FNC 1 character, and replaces other FNC 1 characters with the ASCII 29 (GS) control character.

When AIM symbology identifiers are transmitted, the modifier character indicates the position of the leading FNC 1 character according to AIM guidelines. For example, **jc1** indicates a GS1-128 symbol with a leading FNC1 character.

Standard Code 128 bar codes which do not have a leading FNC 1 may still be used, but are not encoded according to the GS1-128 convention. Standard Code 128 and GS1-128 may be mixed in an application. The CS3070 autodiscriminates between these symbols, and can enable or disable one or both code types. [Table D-5](#) indicates the behavior of the CS3070 in each of the four possible parameter settings.

Table D-5 Reading Standard Code 128 & GS1-128

Standard Code 128	GS1-128	Effect and Example
Disable	Disable	No Code 128 symbols can be read.
Disable	Enable	Read only symbols with leading FNC 1. Examples: FNC1ABCD ^{FNC1} E are read as ABCD ²⁹ E A ^{FNC1} BCD ^{FNC1} E are read as ABCD ²⁹ E FNC1FNC1ABCD ^{FNC1} E are read as ABCD ²⁹ E ABCD ^{FNC1} E cannot be read ABCDE cannot be read
Enable	Disable	Read only symbols without leading FNC 1. Examples: FNC1ABCD ^{FNC1} E cannot be read A ^{FNC1} BCD ^{FNC1} E cannot be read FNC1FNC1ABCD ^{FNC1} E cannot be read ABCD ^{FNC1} E is read as ABCD ²⁹ E ABCDE is read as ABCDE
Enable	Enable	Read both types of symbols. Examples: FNC1ABCD ^{FNC1} E are read as ABCD ²⁹ E A ^{FNC1} BCD ^{FNC1} E are read as ABCD ²⁹ E FNC1FNC1ABCD ^{FNC1} E are read as ABCD ²⁹ E ABCD ^{FNC1} E is read as ABCD ²⁹ E ABCDE is read as ABCDE

Setting Prefixes and Suffixes

To append a prefix and suffixes to the decode data:

1. Set the Scan Data Transmission Format (parameter 0xE2) to the desired option.
2. Enter the required value(s) for Prefix (0x69), Suffix1 (0x68) or Suffix2 (0x6A) using the hex values for the desired ASCII value from [Table D-6](#).

Table D-6 Character Equivalents

Scan Value	Hex Value	Full ASCII Code 39 Encode Char.	Keystroke
1000	00h	%U	CTRL 2
1001	01h	\$A	CTRL A
1002	02h	\$B	CTRL B
1003	03h	\$C	CTRL C
1004	04h	\$D	CTRL D
1005	05h	\$E	CTRL E
1006	06h	\$F	CTRL F
1007	07h	\$G	CTRL G
1008	08h	\$H	CTRL H
1009	09h	\$I	CTRL I
1010	0Ah	\$J	CTRL J
1011	0Bh	\$K	CTRL K
1012	0Ch	\$L	CTRL L
1013	0Dh	\$M	CTRL M
1014	0Eh	\$N	CTRL N
1015	0Fh	\$O	CTRL O
1016	10h	\$P	CTRL P
1017	11h	\$Q	CTRL Q
1018	12h	\$R	CTRL R
1019	13h	\$S	CTRL S
1020	14h	\$T	CTRL T
1021	15h	\$U	CTRL U
1022	16h	\$V	CTRL V
1023	17h	\$W	CTRL W
1024	18h	\$X	CTRL X

Table D-6 *Character Equivalents (Continued)*

Scan Value	Hex Value	Full ASCII Code 39 Encode Char.	Keystroke
1025	19h	\$Y	CTRL Y
1026	1Ah	\$Z	CTRL Z
1027	1Bh	%A	CTRL [
1028	1Ch	%B	CTRL \
1029	1Dh	%C	CTRL]
1030	1Eh	%D	CTRL 6
1031	1Fh	%E	CTRL -
1032	20h	Space	Space
1033	21h	/A	!
1034	22h	/B	'
1035	23h	/C	#
1036	24h	/D	\$
1037	25h	/E	%
1038	26h	/F	&
1039	27h	/G	'
1040	28h	/H	(
1041	29h	/I)
1042	2Ah	/J	*
1043	2Bh	/K	+
1044	2Ch	/L	,
1045	2Dh	-	-
1046	2Eh	.	.
1047	2Fh	/	/
1048	30h	0	0
1049	31h	1	1
1050	32h	2	2
1051	33h	3	3
1052	34h	4	4
1053	35h	5	5
1054	36h	6	6
1055	37h	7	7

Table D-6 Character Equivalents (Continued)

Scan Value	Hex Value	Full ASCII Code 39 Encode Char.	Keystroke
1056	38h	8	8
1057	39h	9	9
1058	3Ah	/Z	:
1059	3Bh	%F	;
1060	3Ch	%G	<
1061	3Dh	%H	=
1062	3Eh	%I	>
1063	3Fh	%J	?
1064	40h	%V	@
1065	41h	A	A
1066	42h	B	B
1067	43h	C	C
1068	44h	D	D
1069	45h	E	E
1070	46h	F	F
1071	47h	G	G
1072	48h	H	H
1073	49h	I	I
1074	4Ah	J	J
1075	4Bh	K	K
1076	4Ch	L	L
1077	4Dh	M	M
1078	4Eh	N	N
1079	4Fh	O	O
1080	50h	P	P
1081	51h	Q	Q
1082	52h	R	R
1083	53h	S	S
1084	54h	T	T
1085	55h	U	U
1086	56h	V	V

Table D-6 *Character Equivalents (Continued)*

Scan Value	Hex Value	Full ASCII Code 39 Encode Char.	Keystroke
1087	57h	W	W
1088	58h	X	X
1089	59h	Y	Y
1090	5Ah	Z	Z
1091	5Bh	%K	[
1092	5Ch	%L	\
1093	5Dh	%M]
1094	5Eh	%N	^
1095	5Fh	%O	_
1096	60h	%W	'
1097	61h	+A	a
1098	62h	+B	b
1099	63h	+C	c
1100	64h	+D	d
1101	65h	+E	e
1102	66h	+F	f
1103	67h	+G	g
1104	68h	+H	h
1105	69h	+I	i
1106	6Ah	+J	j
1107	6Bh	+K	k
1108	6Ch	+L	l
1109	6Dh	+M	m
1110	6Eh	+N	n
1111	6Fh	+O	o
1112	70h	+P	p
1113	71h	+Q	q
1114	72h	+R	r
1115	73h	+S	s
1116	74h	+T	t
1117	75h	+U	u

Table D-6 *Character Equivalents (Continued)*

Scan Value	Hex Value	Full ASCII Code 39 Encode Char.	Keystroke
1118	76h	+V	v
1119	77h	+W	w
1120	78h	+X	x
1121	79h	+Y	y
1122	7Ah	+Z	z
1123	7Bh	%P	{
1124	7Ch	%Q	
1125	7Dh	%R	}
1126	7Eh	%S	~
1127	7Fh		Undefined

Values from 1128 through 1255 may also be set.

APPENDIX E SAMPLE BAR CODES

UPC-A



UPC-E



UPC-E1



NOTE To enable this symbology in order to scan the sample, see [Enable/Disable UPC-E1 on page 4-9](#).



EAN-13



EAN-8



Code 39



Trioptic Code 39

- ✓ **NOTE** To enable this symbology in order to scan the sample, see [Enable/Disable Trioptic Code 39 on page 4-31](#).



Code 93

- ✓ **NOTE** To enable this symbology in order to scan the sample, see [Enable/Disable Code 93 on page 4-37](#).



Code 11

- ✓ **NOTE** To enable this symbology in order to scan the sample, see [Code 11 on page 4-39](#).



Codabar

- ✓ **NOTE** To enable this symbology in order to scan the sample, see [Enable/Disable Codabar on page 4-50](#).



MSI

- ✓ **NOTE** To enable this symbology in order to scan the sample, see [Enable/Disable MSI on page 4-54](#).



Interleaved 2 of 5



GS1 DataBar-14

✓ **NOTE** DataBar-14 must be enabled to read the bar code below (see *GS1 DataBar* on page 12-75).



7612341562341

PDF417



Data Matrix



Maxicode

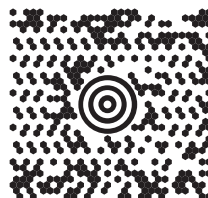

QR Code



Han Xin

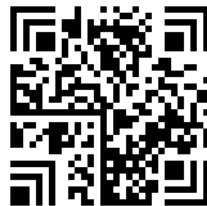

US Postnet



UK Postal



APPENDIX F NUMERIC BAR CODES

Numeric Bar Codes

For parameters requiring specific numeric values, scan the appropriately numbered bar code(s).



0



1

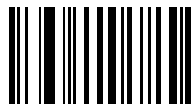

2



3

Numeric Bar Codes (continued)

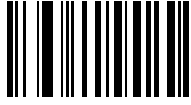

4



5



6



7

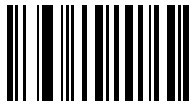

8

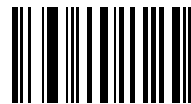

9

Cancel

To correct an error or change a selection, scan the bar code below.



Cancel

APPENDIX G ASCII CHARACTER SETS

Table G-1 *ASCII Value Table*

ASCII Value	Full ASCII Code 39 Encode Char	Keystroke
1000	%U	CTRL 2
1001	\$A	CTRL A
1002	\$B	CTRL B
1003	\$C	CTRL C
1004	\$D	CTRL D
1005	\$E	CTRL E
1006	\$F	CTRL F
1007	\$G	CTRL G
1008	\$H	CTRL H/ BACKSPACE ¹
1009	\$I	CTRL I/ HORIZONTAL TAB ¹
1010	\$J	CTRL J
1011	\$K	CTRL K
1012	\$L	CTRL L
1013	\$M	CTRL M/ ENTER ¹
1014	\$N	CTRL N
1015	\$O	CTRL O

The keystroke in bold transmits only if you enabled Function Key Mapping. Otherwise, the unbold keystroke transmits.

Table G-1 ASCII Value Table (Continued)

ASCII Value	Full ASCII Code 39 Encode Char	Keystroke
1016	\$P	CTRL P
1017	\$Q	CTRL Q
1018	\$R	CTRL R
1019	\$S	CTRL S
1020	\$T	CTRL T
1021	\$U	CTRL U
1022	\$V	CTRL V
1023	\$W	CTRL W
1024	\$X	CTRL X
1025	\$Y	CTRL Y
1026	\$Z	CTRL Z
1027	%A	CTRL [
1028	%B	CTRL \
1029	%C	CTRL]
1030	%D	CTRL 6
1031	%E	CTRL -
1032	Space	Space
1033	/A	!
1034	/B	"
1035	/C	#
1036	/D	\$
1037	/E	%
1038	/F	&
1039	/G	'
1040	/H	(
1041	/I)
1042	/J	*
1043	/K	+
1044	/L	,

The keystroke in bold transmits only if you enabled Function Key Mapping. Otherwise, the unbold keystroke transmits.

Table G-1 ASCII Value Table (Continued)

ASCII Value	Full ASCII Code 39 Encode Char	Keystroke
1045	-	-
1046	.	.
1047	/o	/
1048	0	0
1049	1	1
1050	2	2
1051	3	3
1052	4	4
1053	5	5
1054	6	6
1055	7	7
1056	8	8
1057	9	9
1058	/Z	:
1059	%F	;
1060	%G	<
1061	%H	=
1062	%I	>
1063	%J	?
1064	%V	@
1065	A	A
1066	B	B
1067	C	C
1068	D	D
1069	E	E
1070	F	F
1071	G	G
1072	H	H
1073	I	I

The keystroke in bold transmits only if you enabled Function Key Mapping. Otherwise, the unbold keystroke transmits.

Table G-1 ASCII Value Table (Continued)

ASCII Value	Full ASCII Code 39 Encode Char	Keystroke
1074	J	J
1075	K	K
1076	L	L
1077	M	M
1078	N	N
1079	O	O
1080	P	P
1081	Q	Q
1082	R	R
1083	S	S
1084	T	T
1085	U	U
1086	V	V
1087	W	W
1088	X	X
1089	Y	Y
1090	Z	Z
1091	%K	[
1092	%L	\
1093	%M]
1094	%N	^
1095	%O	_
1096	%W	'
1097	+A	a
1098	+B	b
1099	+C	c
1100	+D	d
1101	+E	e
1102	+F	f

The keystroke in bold transmits only if you enabled Function Key Mapping. Otherwise, the unbold keystroke transmits.

Table G-1 ASCII Value Table (Continued)

ASCII Value	Full ASCII Code 39 Encode Char	Keystroke
1103	+G	g
1104	+H	h
1105	+I	i
1106	+J	j
1107	+K	k
1108	+L	l
1109	+M	m
1110	+N	n
1111	+O	o
1112	+P	p
1113	+Q	q
1114	+R	r
1115	+S	s
1116	+T	t
1117	+U	u
1118	+V	v
1119	+W	w
1120	+X	x
1121	+Y	y
1122	+Z	z
1123	%P	{
1124	%Q	
1125	%R	}
1126	%S	~

The keystroke in bold transmits only if you enabled Function Key Mapping. Otherwise, the unbold keystroke transmits.

Table G-2 *ALT Key Standard Default Tables*

ALT Keys	Keystroke
2064	ALT 2
2065	ALT A
2066	ALT B
2067	ALT C
2068	ALT D
2069	ALT E
2070	ALT F
2071	ALT G
2072	ALT H
2073	ALT I
2074	ALT J
2075	ALT K
2076	ALT L
2077	ALT M
2078	ALT N
2079	ALT O
2080	ALT P
2081	ALT Q
2082	ALT R
2083	ALT S
2084	ALT T
2085	ALT U
2086	ALT V
2087	ALT W
2088	ALT X
2089	ALT Y
2090	ALT Z

Table G-3 *USB GUI Key Character Set*

GUI Key	Keystroke
3000	Right Control Key
3048	GUI 0
3049	GUI 1
3050	GUI 2
3051	GUI 3
3052	GUI 4
3053	GUI 5
3054	GUI 6
3055	GUI 7
3056	GUI 8
3057	GUI 9
3065	GUI A
3066	GUI B
3067	GUI C
3068	GUI D
3069	GUI E
3070	GUI F
3071	GUI G
3072	GUI H
3073	GUI I
3074	GUI J
3075	GUI K
3076	GUI L
3077	GUI M
3078	GUI N
3079	GUI O
3080	GUI P
3081	GUI Q

Note: GUI Shift Keys - The Apple™ iMac keyboard has an apple key on either side of the space bar. Windows-based systems have a GUI key to the left of the left ALT key, and to the right of the right ALT key.

Table G-3 *USB GUI Key Character Set (Continued)*

GUI Key	Keystroke
3082	GUI R
3083	GUI S
3084	GUI T
3085	GUI U
3086	GUI V
3087	GUI W
3088	GUI X
3089	GUI Y
3090	GUI Z

Note: GUI Shift Keys - The Apple™ iMac keyboard has an apple key on either side of the space bar. Windows-based systems have a GUI key to the left of the left ALT key, and to the right of the right ALT key.

Table G-4 *PF Key Standard Default Table*

PF Keys	Keystroke
4001	PF 1
4002	PF 2
4003	PF 3
4004	PF 4
4005	PF 5
4006	PF 6
4007	PF 7
4008	PF 8
4009	PF 9
4010	PF 10
4011	PF 11
4012	PF 12
4013	PF 13
4014	PF 14
4015	PF 15
4016	PF 16

Table G-5 *F Key Standard Default Table*

F Keys	Keystroke
5001	F 1
5002	F 2
5003	F 3
5004	F 4
5005	F 5
5006	F 6
5007	F 7
5008	F 8
5009	F 9
5010	F 10
5011	F 11
5012	F 12
5013	F 13
5014	F 14
5015	F 15
5016	F 16
5017	F 17
5018	F 18
5019	F 19
5020	F 20
5021	F 21
5022	F 22
5023	F 23
5024	F 24

Table G-6 *Numeric Key Standard Default Table*

Numeric Keypad	Keystroke
6042	*
6043	+
6044	Undefined
6045	-
6046	.
6047	/
6048	0
6049	1
6050	2
6051	3
6052	4
6053	5
6054	6
6055	7
6056	8
6057	9
6058	Enter
6059	Num Lock

Table G-7 *Extended Keypad Standard Default Table*

Extended Keypad	Keystroke
7001	Break
7002	Delete
7003	Pg Up
7004	End
7005	Pg Dn
7006	Pause
7007	Scroll Lock
7008	Backspace
7009	Tab
7010	Print Screen
7011	Insert
7012	Home
7013	Enter
7014	Escape
7015	Up Arrow
7016	Dn Arrow
7017	Left Arrow
7018	Right Arrow

INDEX

Numerics

123Scan2	1-8, 5-1
2D bar codes	
aztec	4-83
aztec inverse	4-83
code 128 emulation	4-78
data matrix	4-79
data matrix inverse	4-79
decode mirror images	4-80
han xin	4-84
han xin inverse	4-84
maxicode	4-81
microPDF417	4-77
microQR	4-82
PDF417	4-77
QR code	4-81
QR inverse	4-82

A

accessories	
dongle	B-14
eight-slot charging cradle	B-5
eight-slot spare battery charger	B-7
lanyard	B-2, B-16
single-slot cradle	B-2, B-3
wall mount bracket	B-2, B-9, B-11
ADF	6-1
advanced data formatting	6-1
aiming	2-1
ALT key values	G-6
Android pairing	C-3
accessing phone keyboard	C-4
ASCII values	G-1
autoreconnect	3-10
autorun	2-2

B

bar codes	
Australia post	4-73
Australia post format	4-74
aztec	4-83
aztec inverse	4-83
beep after good decode	3-13
beeper tone	3-15
beeper volume	3-14
bi-directional redundancy	4-87
bluetooth options	3-7
bluetooth profile	3-8
bookland EAN	4-10
bookland ISBN	4-11
cancel	F-3
check ISBT table	4-29
Chinese 2 of 5	4-58
clear data	3-9
codabar	4-50
codabar CLSI editing	4-52
codabar lengths	4-50
codabar NOTIS editing	4-52
codabar start and stop characters	4-53
code 11	4-39
code 11 check digit verification	4-41
code 11 check digits	4-42
code 11 lengths	4-39
code 128	4-25
code 128 emulation	4-78
code 128 lengths	4-25
code 128 security level	4-30
code 32 prefix	4-32
code 39	4-31
code 39 check digit verification	4-34
code 39 full ASCII	4-35
code 39 lengths	4-33

code 39 security level	4-36	microQR	4-82
code 39 transmit check digit	4-34	mirrored image	3-19
code 93	4-37	mobile phone/display mode	3-19
code 93 lengths	4-37	MSI	4-54
composite CC-A/B	4-67	MSI check digit algorithm	4-57
composite CC-C	4-67	MSI check digits	4-56
composite code emulation mode	4-69	MSI lengths	4-54
composite TLC-39	4-68	MSI transmit check digit	4-56
convert code 39 to code 32	4-32	mute beeper	3-15
convert GS1 databar to UPC/EAN	4-65	Netherlands KIX code	4-75
convert UPC-E to UPC-A	4-22	numeric	F-1
convert UPC-E1 to UPC-A	4-22	numeric for pin entry	C-9
D 2 of 5	4-48	pager motor	3-16
D 2 of 5 lengths	4-48	parameter scanning	3-13
data matrix	4-79	PDF prioritization	3-20
data matrix decode mirror images	4-80	PDF prioritization timeout	3-20
data matrix inverse	4-79	PDF417	4-77
decode pager motor	3-16	picklist mode	3-18
decode pager motor duration	3-16	postal	4-70
disable all code types	4-7	prefix/suffix values	3-22
EAN zero extend	4-23	QR code	4-81
EAN-13/JAN-13	4-10	QR inverse	4-82
EAN-8/JAN-8	4-9	radio output power	3-12
enable all code types	4-7	redundancy level	4-85
fuzzy 1D processing	3-18	reset to factory defaults	3-4
GS1 databar	4-64	sample	E-1
GS1 databar expanded	4-65	scan data options	3-23
GS1 databar limited	4-64	security level	4-88
GS1 databar limited security level	4-66	send versions	3-25
GS1 databar-14	4-64	set date and time	3-5
GS1-128	4-27	supplementals	4-12
han xin	4-84	symbologies	
han xin inverse	4-84	default table	4-2
HID CoD	3-12	transmit code ID character	3-21
HID security	3-11	transmit matrix 2 of 5 check digit	4-61
I 2 of 5	4-43	transmit no read message	3-24
I 2 of 5 check digit verification	4-45	transmit UK postal check digit	4-72
I 2 of 5 convert to EAN-13	4-46	transmit US postal check digit	4-71
I 2 of 5 lengths	4-43	trioptic code 39	4-31
I 2 of 5 security level	4-47	UCC coupon extended code	4-23
I 2 of 5 transmit check digit	4-46	UK postal	4-71
intercharacter gap size	4-89	unpair	3-8
inverse 1D	4-63	UPC composite mode	4-68
ISBT 128	4-27	UPC/EAN supplemental redundancy	4-15
ISBT concatenation	4-28	UPC/EAN/JAN supplemental AIM ID format	4-16
ISBT concatenation redundancy	4-29	UPC-A	4-8
ISSN EAN	4-24	UPC-A preamble	4-19
Japan postal	4-72	UPC-A/E/E1 check digit	4-17, 4-18
Korean 3 of 5	4-62	UPC-E	4-8
matrix 2 of 5	4-59	UPC-E preamble	4-20
matrix 2 of 5 check digit	4-61	UPC-E1	4-9
matrix 2 of 5 lengths	4-59	UPC-E1 preamble	4-21
maxicode	4-81	UPU FICS postal	4-76
microPDF417	4-77	US planet	4-70

- US postnet 4-70
 - user-programmable supplementals 4-15
 - USPS 4CB/One Code/Intelligent Mail 4-75
 - batch 1-5
 - transmitting data 2-2
 - battery
 - charge status 2-3
 - charging 1-4
 - indications B-8
 - charging in cradle B-2, B-3, B-5
 - charging indications B-4, B-6
 - charging spare 1-4, B-3, B-7
 - charging temperature 1-4
 - depleted 2-4
 - inserting 1-2
 - lithium-ion 1-2
 - removing 1-3
 - beeper
 - beep on decode 3-13
 - definitions 2-5
 - muting 1-10, 3-15
 - setting tone 3-15
 - setting volume 3-14
 - tooggling 2-2
 - troubleshooting 7-2
 - bluetooth 1-1
 - address 1-8
 - bar codes 3-7
 - beeper definitions 2-5
 - connecting 1-5
 - disable button 1-9
 - dongle B-14
 - dongle mounting B-15
 - dongle pairing B-15
 - HID 1-5
 - set security 1-10
 - HID profile 3-8
 - HID security 3-11
 - LED definitions 2-4
 - master and slave 3-7
 - network connectivity B-4, B-6
 - out of range 2-3, 7-2
 - pairing 1-6
 - pairing bar code format 3-7
 - PIN code 1-9
 - profiles 3-8
 - radio output power 3-12
 - serial number 1-8
 - serial port profile 1-5
 - SPP profile 3-8
 - SSI profile 3-8
 - transmitting data 2-3
 - unpairing 3-8
 - booting the device 1-4
 - bullets xv
 - buttons 1-1
 - bluetooth 1-9
 - delete 2-2
- ## C
- cable 1-5
 - communication setup 1-5
 - charging
 - LED definitions 2-4
 - charging battery 1-4, B-2, B-8
 - in cradle B-3, B-5
 - in spare battery charger B-7
 - indications B-4, B-6
 - charging indications B-4, B-6, B-8
 - charging temperature 1-4
 - Chinese 2 of 5 bar codes 4-58
 - cleaning 7-1
 - clearing data 3-9
 - codabar bar codes 4-50
 - CLSI editing 4-52
 - lengths 4-50
 - NOTIS editing 4-52
 - start and stop characters 4-53
 - code 11 bar codes 4-39
 - check digit verification 4-41
 - check digits 4-42
 - lengths 4-39
 - code 128 bar codes
 - check ISBT table 4-29
 - code 128 4-25
 - GS1-128 4-27
 - ISBT 128 4-27
 - ISBT concatenation 4-28
 - ISBT concatenation redundancy 4-29
 - lengths 4-25
 - security level 4-30
 - code 128 emulation bar codes 4-78
 - code 39 bar codes
 - check digit verification 4-34
 - code 32 prefix 4-32
 - code 39 4-31
 - convert to code 32 4-32
 - full ASCII 4-35
 - lengths 4-33
 - security level 4-36
 - transmit check digit 4-34
 - trioptic Code 39 4-31
 - code 93 bar codes 4-37
 - lengths 4-37
 - code identifiers
 - AIM D-6
 - code type IDs D-1

modifier characters D-7
 Symbol D-4
 cold boot 1-4
 communication setup 1-5
 composite bar codes
 composite CC-A/B 4-67
 composite CC-C 4-67
 composite TLC-39 4-68
 emulation mode 4-69
 UPC composite mode 4-68
 configuration file 1-8
 editing 1-9
 parameters 1-9
 configuring scanner 1-8
 123Scan2 1-8
 configuration file 1-8
 editing configuration file 1-9
 multiple scanners 1-8
 updating firmware 1-8
 connecting
 batch 1-5
 bluetooth 1-5
 pairing 1-6
 to host 1-5
 connectivity
 bluetooth B-4, B-6
 conventions
 notational xv
 cradles
 eight-slot B-5
 eight-slot spare charger B-7
 mounting B-9, B-11
 setting up B-3, B-5, B-7
 single-slot B-2, B-3

D

data matrix bar codes 4-79
 decode mirror images 4-80
 inverse 4-79
 date
 setting 3-5, 3-6
 date format 1-10
 default parameters 3-2, A-1
 symbolologies 4-2
 user preferences 3-2
 default table A-1
 deleting bar codes 2-2, 2-3
 deleting device 1-7
 devices supported 1-6
 discrete 2 of 5 bar codes 4-48
 lengths 4-48
 dongle B-14, B-15
 mounting B-15

E

extended keypad values G-12

F

F key values G-10
 firmware
 updating 1-8

G

GS1 databar bar codes 4-64
 convert to UPC/EAN 4-65
 expanded 4-65
 GS1 databar-14 4-64
 limited 4-64
 limited security level 4-66
 GS1-128 D-11

H

host connection 1-5
 human interface device (HID) 1-5
 security 3-11
 set security 1-10
 setting 3-8

I

inserting battery 1-2
 interfaces 1-1
 interleaved 2 of 5 bar codes 4-43
 check digit verification 4-45
 convert to EAN-13 4-46
 lengths 4-43
 security level 4-47
 transmit check digit 4-46
 iPad pairing C-2

K

Korean 3 of 5 bar codes 4-62

L

lanyard B-2, B-16
 LED
 charging indications B-8
 definitions 2-3
 enabling 1-10
 scanning 2-3
 troubleshooting 7-2
 lithium-ion battery 1-2

M

maintenance	7-1
matrix 2 of 5 bar codes	4-59
check digit	4-61
lengths	4-59
transmit check digit	4-61
maxicode bar codes	4-81
microPDF417 bar codes	4-77
MSI bar codes	4-54
check digit algorithm	4-57
check digits	4-56
lengths	4-54
transmit check digit	4-56

N

notational conventions	xv
numeric bar codes	
for pin entry	C-9
numeric key values	G-11

O

operating systems supported	1-6
-----------------------------	-----

P

pager	
duration	3-16
enabling	1-10, 3-16
pairing	1-5, 1-6
address	3-10
bar code format	3-7
LED	2-4
via dongle	B-15
pairing examples	C-1
Android	C-3
iPad	C-2
Windows 7	C-5
Windows 8	C-7
parameters	
configuration file	1-9
default	A-1
defaults	3-2
enable scanning	3-13
scanning	3-2
setting date and time	3-5
parts diagram	1-1
PDF417 bar codes	4-77
PF key values	G-9
picklist mode	3-18
pin	
numeric bar codes	C-9

postal codes	4-70
Australia post	4-73
Australia post format	4-74
Japan postal	4-72
Netherlands KIX code	4-75
transmit UK postal check digit	4-72
transmit US postal check digit	4-71
UK postal	4-71
UPU FICS postal	4-76
US planet	4-70
US postnet	4-70
USPS 4CB/One Code/Intelligent Mail	4-75
power off cradle	B-4
prefix/suffix values	3-22
prefixes	D-12

Q

QR code bar codes	4-81
inverse	4-82
microQR	4-82

R

radio output power	3-12
removing battery	1-3
resetting scanner	
to factory defaults	3-4

S

sample bar codes	E-1
scanner defaults	3-2, A-1
scanning	2-1
aiming	2-1
beeper	2-5
disable functionality	1-10
errors	3-1, 4-2
LED	2-3
parameters	3-1
sequence example	4-1
transmitting data	2-2
serial port profile	1-5
setting	3-8
service information	xvi
setup	
123Scan2	1-8
Android pairing	C-3
bluetooth	1-5
charging battery	1-4
configuration file	1-8
configuring scanner	1-8
connecting to host	1-5
editing configuration file	1-9

eight-slot cradle	B-5
eight-slot spare charger	B-7
inserting battery	1-2
iPad pairing	C-2
multiple scanners	1-8
pairing	1-6
single-slot cradle	B-3
unpacking	1-2
updating firmware	1-8
wall mount bracket	B-9, B-11
Windows 7 pairing	C-5
Windows 8 pairing	C-7
single-slot cradle	B-2
spare batteries	1-4
charging in cradle	B-3, B-7
spare battery charger	B-2
specifications	7-3
suffixes	D-12
support	.xvi
supported devices	1-6
symbology default parameters	4-2

T

technical specifications	7-3
temperature	
charging battery	1-4
time	
setting	3-5, 3-6
transmitting data	2-2
bluetooth	2-3
troubleshooting	7-2

U

unpacking	1-2
unpairing	1-7, 3-8
UPC/EAN bar codes	
bookland EAN	4-10
bookland ISBN	4-11
check digit	4-17, 4-18
convert UPC-E to UPC-A	4-22
convert UPC-E1 to UPC-A	4-22
EAN zero extend	4-23
EAN-13/JAN-13	4-10
EAN-8/JAN-8	4-9
ISSN EAN	4-24
supplemental AIM ID format	4-16
supplemental redundancy	4-15
supplementals	4-12
UCC coupon extended code	4-23
UPC-A	4-8
UPC-A preamble	4-19
UPC-E	4-8

UPC-E preamble	4-20
UPC-E1	4-9
UPC-E1 preamble	4-21
user-programmable supplementals	4-15
updating firmware	1-8
USB	1-1
USB cable	1-5
USB GUI key values	G-7
user interface	2-3
LED definitions	2-3
user preferences parameters	3-2

V

value tables	
ALT key	G-6
ASCII	G-1
extended keypad	G-12
F keys	G-10
numeric keys	G-11
PF keys	G-9
USB GUI keys	G-7
version	
bar codes	3-25

W

wall mount bracket	B-2, B-9, B-11
Windows 7 pairing	C-5
Windows 8 pairing	C-7



Zebra Technologies Corporation
Lincolnshire, IL U.S.A.
<http://www.zebra.com>

Zebra and the Zebra head graphic are registered trademarks of ZIH Corp. The Symbol logo is a registered trademark of Symbol Technologies, Inc., a Zebra Technologies company.

© 2015 Symbol Technologies Inc.



MN000762A03 Revision A - March 2015

