

DS36X8

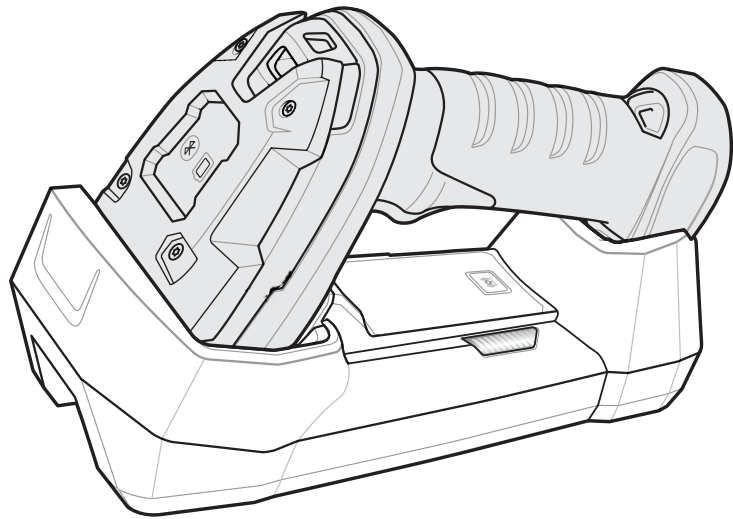

Digital Scanner

Product Reference Guide

DS36X8 DIGITAL SCANNER PRODUCT REFERENCE GUIDE

MN-002689-19EN

Revision A

August 2024

No part of this publication may be reproduced or used in any form, or by any electrical or mechanical means, without permission in writing from Zebra. This includes electronic or mechanical means, such as photocopying, recording, or information storage and retrieval systems. The material in this manual is subject to change without notice.

The software is provided strictly on an “as is” basis. All software, including firmware, furnished to the user is on a licensed basis. Zebra grants to the user a non-transferable and non-exclusive license to use each software or firmware program delivered hereunder (licensed program). Except as noted below, such license may not be assigned, sublicensed, or otherwise transferred by the user without prior written consent of Zebra. No right to copy a licensed program in whole or in part is granted, except as permitted under copyright law. The user shall not modify, merge, or incorporate any form or portion of a licensed program with other program material, create a derivative work from a licensed program, or use a licensed program in a network without written permission from Zebra. The user agrees to maintain Zebra’s copyright notice on the licensed programs delivered hereunder, and to include the same on any authorized copies it makes, in whole or in part. The user agrees not to decompile, disassemble, decode, or reverse engineer any licensed program delivered to the user or any portion thereof.

Zebra reserves the right to make changes to any product to improve reliability, function, or design.

Zebra does not assume any product liability arising out of, or in connection with, the application or use of any product, circuit, or application described herein. No license is granted, either expressly or by implication, estoppel, or otherwise under any patent right or patent, covering or relating to any combination, system, apparatus, machine, material, method, or process in which Zebra products might be used. An implied license exists only for equipment, circuits, and subsystems contained in Zebra products.

This product may include Seller Software, Third Party Software, and/or Publicly Available Software.

Use of any Software is subject to the applicable licenses, terms and conditions of the agreement in force between you and the Seller unless a separate License is included, in which case, use of the Software will be governed by the separate License.

Copies of the licenses for the following Publicly Available Software, and all attributions, acknowledgments, and software information details, are included below. Seller is required to reproduce the software licenses, acknowledgments and copyright notices as provided by the Authors and Owners. The information is provided in its native language form, without modification or translation.

Publicly available software list:

Name: Regular Expression Evaluator

Version: 8.3

Description: Compiles and executes regular expressions

Software Site: <http://www.freebsd.org/cgi/cvsweb.cgi/src/lib/libc/regex/>

Source Code: No Source Distribution Obligations. Seller will not provide nor distribute the Source Code for the Regular Expression Evaluator.

License: BSD Style License

© 1992 Henry Spencer.

© 1992, 1993 The Regents of the University of California. All rights reserved.

This code is derived from software contributed to Berkeley by Henry Spencer of the University of Toronto. Redistribution and use in source and binary forms, with or without modification, are permitted provided that the following conditions are met:

1. Redistributions of source code must retain the above copyright notice, this list of conditions and the following disclaimer.
2. Redistributions in binary form must reproduce the above copyright notice, this list of conditions and the following disclaimer in the documentation and/or other materials provided with the distribution.

3. All advertising materials mentioning features or use of this software must display the following acknowledgment:

This product includes software developed by the University of California, Berkeley and its contributors.

4. Neither the name of the University nor the names of its contributors may be used to endorse or promote products derived from this software without specific prior written permission.

THIS SOFTWARE IS PROVIDED BY THE REGENTS AND CONTRIBUTORS "AS IS" AND ANY EXPRESS OR IMPLIED WARRANTIES, INCLUDING, BUT NOT LIMITED TO, THE IMPLIED WARRANTIES OF MERCHANTABILITY AND FITNESS FOR A PARTICULAR PURPOSE ARE DISCLAIMED. IN NO EVENT SHALL THE REGENTS OR CONTRIBUTORS BE LIABLE FOR ANY DIRECT, INDIRECT, INCIDENTAL, SPECIAL, EXEMPLARY, OR CONSEQUENTIAL DAMAGES (INCLUDING, BUT NOT LIMITED TO, PROCUREMENT OF SUBSTITUTE GOODS OR SERVICES; LOSS OF USE, DATA, OR PROFITS; OR BUSINESS INTERRUPTION) HOWEVER CAUSED AND ON ANY THEORY OF LIABILITY, WHETHER IN CONTRACT, STRICT LIABILITY, OR TORT (INCLUDING NEGLIGENCE OR OTHERWISE) ARISING IN ANY WAY OUT OF THE USE OF THIS SOFTWARE, EVEN IF ADVISED OF THE POSSIBILITY OF SUCH DAMAGE.

For further information regarding legal and proprietary statements, please go to:

SOFTWARE: zebra.com/linkoslegal.

COPYRIGHTS: zebra.com/copyright.

PATENTS: ip.zebra.com.

WARRANTY: zebra.com/warranty.

END USER LICENSE AGREEMENT: zebra.com/eula.

Revision History

Changes to the original guide are listed below:

Change	Date	Description
-01 Rev A	06/2016	Initial release.
-02 Rev A	08/2016	Added DS3678-ER configuration.
-03 Rev A	01/2017	Added DS36X8-DP configuration; combined corded and cordless Product Reference Guides; replaced all 1D barcodes with 2D Data Matrix barcodes.
-04 Rev A	12/2017	<p>Configuration updates include: Remove - PWRS-14000-148R, CBL-36-453A-01 Add - PWRS-BGA12V50W0WW, CBL-DC-451A1-01, CBA-RF5-S07ZAR, CBA-RF4-C09ZAR, CBA-UF6-C12ZAR, CBA-UF5-C09ZAR, CBA-UF4-C09ZAR, CBA-UF3-C09ZAR</p> <p>Added: - Save BT Connection Information - DS3608-ER Power Mode</p> <p>Updated: - HID Keyboard Emulation barcode caption to USB HID Keyboard. - USB OPOS Hand-held barcode caption to OPOS (IBM Hand-held with Full Disable). - Corrected Medium host character value - MOD 10/MOD 11 to MOD 11/MOD 10 - Baud Rate 230,400 - 13 (0Bh) - Baud Rate 460,800 - 14 (0Ch) - Baud Rate 921,600 - 15 (0Dh) - Beep on <BEL> default is Enable</p>
-05 Rev A	5/2018	<p>Added: Document Feedback statement and removed Feedback page; Outdoor Picklist Mode; Pull Trigger Twice to Re-connect, PID Type and Value; note to Simulated Caps Lock; Codabar Security Level; Codabar Mod 16 Check Digit Verification and Transmit Codabar Check Digit; MSI Reduced Quiet Zone; Note for Inverse 1D; GS1 Databar Security Level; Composite Inverse; Linked QR Mode; Grid Matrix, Grid Matrix Inverse, and Grid Matrix Mirrored; Digimarc Barcode chapter; OCR Redundancy; note to Out of Range Batch Mode option.</p> <p>Removed Bluetooth HID - Wait for Connection parameter.</p> <p>Updated: Pairing Methods description; Beep Directive and barcode Configuration Directive for the IBM host; renamed GS1 DataBar Limited Security Level parameter to GS1 DataBar Limited Margin Check and updated description; OCR Template default; 123Scan chapter; Code ID tables.</p>

Change	Date	Description
-06 Rev A	9/2018	Added: DS36X8-DPA configurations and decode zone table; Shutting Off the Battery; Sleep Between Attempts (parameter #1778); Number of Retry Attempts (parameter #1779); Battery Preservation Mode (parameter #1765); DPM Rough Shiny Surface Decoding (parameter #1904); Ultra High Density DPM Decoding (parameter #1903) Added notes to: Codabar Security Level (parameter #1776); Codabar Mod 16 Check Digit Verification (parameter #1784); Linked QR Mode (parameter #1847); Timeout to Low Power Mode from Auto Aim (parameter #729); Video View Finder (parameter #324)
-07 Rev A	03/2019	Added: Bluetooth Radio State; DotCode Parameters and note related to SR and HD configurations; IBM-485 Specification Version; Note to Simulated Caps Lock parameter. Updated: MSI Check Digits, the range of DocCap_SYMBOLOGY parameter. Removed: Simple Com Port Emulation.
-08 Rev A	07/2019	Updated: UID Parsing note; OCR Template Parameter #547 description. Removed: Digimarc Barcode note.
-09 Rev A	10/2019	Removed: Require and Suppress
-10EN Rev A	03/2020	- Added Low Power Mode note. - Added MDF in Hands-Free Mode. - Updated DS3608 Hands-free Mode. - Split 123Scan chapter to Chapter 2 123Scan and Software Tools and Chapter 16 Data Formatting: ADF, MDF, Preferred Symbol.
-11EN Rev A	11/2020	- Added note to 123Scan. - Removed Bluetooth Classic Bluetooth and/or Low Energy (Cradle Parameter Only/ Cradle Host Only).
-12EN Rev A	12/2020	Removed offensive terms.
-13EN Rev A	07/2021	- Added: DS3678-HP with Keypad & Display to configurations; Virtual Tether parameters; Note referring to the DS3678-HP PRG Supplement for DS3678-HP with Keypad & Display LED/Beeper definitions; Note referring to the DS3678-HP PRG Supplement for DS3678-HP with Keypad & Display parts and features; Battery Threshold parameters to not apply to DS3678-HP with Keypad & Display; Very Low Radio Output Power.
-15EN Rev A	05/2023	- Corrected callout lines for the mounting screw hole under the Cradle parts section for the cradle back view graphic. Figure 1-5.

Change	Date	Description
-16EN Rev A	06/2023	<ul style="list-style-type: none"> - Updated Note in the Introduction for Bluetooth Radio State (Parameter # 1354). - Updated Note in the Introduction for Chapter 15 Digimarc Barcode <p>Added:</p> <ul style="list-style-type: none"> - Very Low Power bar code for Radio Output Power (parameter #1324). - AutoConfig (Scanner Cloning Through Cradle) (parameter #2139). - Datalogic USB CDC Host Variant bar code, Datalogic Variant bar code. - Datalogic Host Format (parameter# 2253), and Datalogic Supported Commands (parameter #2260) - Virtual Tether parameters; Configuring the Alarm on the Scanner (parameter #2053), Audio Virtual Tether Alarm on Scanner (parameter #2246), LED Virtual Tether Alarm on Scanner (parameter #2247), Illumination Virtual Tether Alarm on Scanner (parameter #2248), Haptic Virtual Tether Alarm on Scanner (parameter #2249), Virtual Tether Alarm on the Cradle (parameter #2124), Delay Before Virtual Alarm Activates (parameter #2054), Virtual Tether Alarm Duration (parameter #2055), Defeat Virtual Tether Alarm (parameter #2119), Pause Virtual Tether Alarm Duration (parameter #2120) - Triggered Timeout, Same Symbol (parameter #724)
-17EN Rev A	03/2024	<p>Updated the following to include XR:</p> <ul style="list-style-type: none"> - DS36X8 Scanning - DS36X8 Aiming - DS36X8 Decode Ranges - DS36X8 Technical Specifications <p>Parameters:</p> <ul style="list-style-type: none"> - Hand-held Trigger Mode (#138) - Hand-held Decode Aiming Pattern (#306) - Imaging Preferences
-18EN Rev A	07/2024	<p>Updated to include USB Certification information:</p> <ul style="list-style-type: none"> - Table 4-2: Technical Specifications - DS3678 and DS3608 Digital Scanners (only for DS3608) <p>Added USB Logo:</p> <ul style="list-style-type: none"> - Connecting DS3608 to USB Interface
-19EN Rev A	08/2024	Replaced FIPS 140-2 with FIPS 140-3.

TABLE OF CONTENTS

Revision History	iv
------------------------	----

About This Guide

Introduction	xxiii
Configurations	xxiii
DS3678 Configurations	xxiii
DS3608 Configurations	xxvi
Related Product Line Configurations	xxviii
Related DS3678 Product Line Configurations	xxviii
Related DS3608 Product Line Configurations	xxx
Chapter Descriptions	xxxii
Notational Conventions	xxxiii
Related Documents	xxxiv
Service Information	xxxiv
Provide Documentation Feedback	xxxv

Chapter 1: Getting Started

Introduction	1-1
Unpacking	1-2
DS3678 Cordless Digital Scanner	1-3
DS3678 Parts	1-3
The Cradle	1-3
DS3678 Battery	1-7
Inserting the DS3678 Scanner in the Cradle	1-10
Sending Data to the Host Computer	1-11
Configuring the Scanner	1-11
Radio Communications	1-11
Four Slot Spare Battery Charger	1-12
Lanyard	1-13
DS3678 Accessories	1-14
DS3608 Corded Digital Scanner	1-15
DS3608 Parts	1-15
Installing the DS3608 Interface Cable	1-16
Removing the DS3608 Interface Cable	1-17

Connecting Power to the DS3608 (if required)	1-18
Configuring the DS3608 Digital Scanner	1-18
DS3608 Accessories	1-18
Chapter 2: 123Scan and Software Tools	
Introduction	2-1
123Scan	2-1
Communication with 123Scan	2-2
123Scan Requirements	2-2
123Scan Information	2-2
Scanner SDK, Other Software Tools, and Videos	2-3
Chapter 3: Data Capture	
Introduction	3-1
DS3678 Beeper and LED Definitions	3-1
Radio and Beeper LED Definitions	3-1
Cradle LED Definitions	3-5
Four Slot Battery Charger Definitions	3-6
DS3608 Beeper and LED Definitions	3-7
DS36X8 Scanning	3-9
DS3608 Hands-free Mode	3-11
Scanning in Hands-free (Presentation) Mode	3-11
DS36X8 Aiming	3-12
Aiming with DS36X8-SR	3-12
Aiming with DS36X8-HD and DS36X8-HP	3-12
Aiming with DS36X8-XR	3-12
Aiming with DS36X8-ER	3-13
Aiming with DS36X8-DP	3-13
DS36X8 Decode Ranges	3-14
Chapter 4: Maintenance & Technical Specifications	
Introduction	4-1
Maintenance	4-1
Known Harmful Ingredients	4-1
Approved Cleaning Agents	4-1
Tolerable Industrial Fluids and Chemicals	4-2
Cleaning the Digital Scanner	4-2
Troubleshooting	4-3
Report Software Version Bar Code	4-6
Technical Specifications	4-7
DS36X8 Technical Specifications	4-7
Cradle Specifications	4-10
DS3608 Digital Scanner Signal Descriptions	4-12
Chapter 5: Radio Communications	
Introduction	5-1

Scanning Sequence Examples	5-1
Errors While Scanning	5-1
Radio Communications Parameter Defaults	5-2
Wireless Beeper Definitions	5-5
Radio Communications Host Types	5-5
Cradle	5-5
Keyboard Emulation (HID)	5-6
Simple Serial Interface (SSI)	5-7
Serial Port Profile (SPP)	5-9
Bluetooth Technology Profile Support	5-10
Central/Peripheral Set Up	5-10
Bluetooth Friendly Name	5-11
Discoverable Mode	5-12
Wi-Fi Friendly Mode	5-13
Wi-Fi Friendly Channel Exclusion	5-14
Radio Output Power	5-17
Link Supervision Timeout	5-18
Bluetooth Radio State	5-19
HID Host Parameters	5-20
Apple iOS Virtual Keyboard Toggle	5-20
HID Keyboard Keystroke Delay	5-21
HID CAPS Lock Override	5-21
HID Ignore Unknown Characters	5-22
Emulate Keypad	5-22
Fast HID Keyboard	5-23
Quick Keypad Emulation	5-23
HID Keyboard FN1 Substitution	5-24
HID Function Key Mapping	5-24
Simulated Caps Lock	5-25
Convert Case	5-25
Reconnect Attempt Beep Feedback	5-26
Reconnect Attempt Beep Feedback	5-27
Reconnect Attempt Interval	5-28
Auto-reconnect	5-30
Sleep Between Attempts	5-31
Number of Retry Attempts	5-32
Out of Range Indicator	5-34
Beep on Insertion	5-34
Digital Scanner(s) To Cradle Support	5-35
Modes of Operation	5-35
Parameter Broadcast (Cradle Host Only)	5-36
Pairing	5-36
Pairing Bar Code Format	5-40
Connection Maintenance Interval	5-40
AutoConfig (Scanner Cloning Through Cradle)	5-43
Batch Mode	5-45
Persistent Batch Storage	5-48
Page Button	5-49
Page Options	5-50
Page Mode	5-50
Page State Timeout	5-51

Bluetooth Security	5-52
PIN Code	5-52
Bluetooth Security Levels	5-54
Save Bluetooth Connection Information	5-56
Virtual Tether	5-57
Configuring the Alarm on the Scanner	5-57
Virtual Tether Alarm on the Cradle	5-60
Delay Before Virtual Alarm Activates	5-60
Virtual Tether Alarm Duration	5-61
Defeat Virtual Tether Alarm	5-62
Pause Virtual Tether Alarm Duration	5-63
Bluetooth Radio, Linking, and Batch Operation	5-65
Setting Up an iOS or Android Product To Work With The Digital Scanner	5-65

Chapter 6: User Preferences & Miscellaneous Options

Introduction	6-1
Scanning Sequence Examples	6-2
Errors While Scanning	6-2
User Preferences Parameter Defaults	6-2
User Preferences	6-5
Default Parameters	6-5
Parameter Bar Code Scanning	6-6
Beep After Good Decode	6-6
Beep on <BEL>	6-7
Direct Decode Indicator	6-8
Beeper Volume	6-9
Beeper Tone	6-10
Beeper Duration	6-11
Suppress Power Up Beeps	6-12
Decode Pager Motor	6-13
Decode Pager Motor Duration	6-13
Low Power Mode	6-15
Timeout to Low Power Mode from Auto Aim	6-19
DS3608-ER Power Mode	6-20
Battery Preservation Mode	6-20
Hand-held Trigger Mode	6-22
Hands-free Mode	6-23
Hand-held Decode Aiming Pattern	6-24
Hands-free Decode Aiming Pattern	6-25
Picklist Mode	6-26
Outdoor Picklist Mode	6-27
FIPS Mode	6-28
Continuous Bar Code Read	6-28
Unique Bar Code Reporting	6-29
Decode Session Timeout	6-30
Hands-free Decode Session Timeout	6-30
Timeout Between Decodes, Same Symbol	6-31
Timeout Between Decodes, Different Symbols	6-31
Triggered Timeout, Same Symbol	6-32
Mobile Phone/Display Mode	6-33

PDF Prioritization	6-34
PDF Prioritization Timeout	6-35
Presentation Mode Field of View	6-36
Decoding Illumination	6-37
Motion Tolerance (Hand-held Trigger Modes Only)	6-37
Ranging Light Immunity	6-38
Battery Threshold	6-39
Add an Enter Key	6-41
Transmit Code ID Character	6-42
Prefix/Suffix Values	6-43
Scan Data Transmission Format	6-44
FN1 Substitution Values	6-45
Transmit “No Read” Message	6-46
Unsolicited Heartbeat Interval	6-47
Product ID (PID) Type	6-48
Product ID (PID) Value	6-49
UID Parsing	6-50
DPM Mode	6-56
DPM Illumination Control	6-57
DPM Rough Shiny Surface Decoding	6-58
Ultra High Density DPM Decoding	6-59
Chapter 7: Imaging Preferences	
Introduction	7-1
Scanning Sequence Examples	7-2
Errors While Scanning	7-2
Imaging Preferences Parameter Defaults	7-2
Imaging Preferences	7-4
Operational Modes	7-4
Image Capture Illumination	7-5
Image Capture Autoexposure	7-5
Fixed Exposure	7-6
Gain/Exposure Priority for Snapshot Mode	7-7
Snapshot Mode Timeout	7-8
Snapshot Aiming Pattern	7-9
Silence Operational Mode Changes	7-9
Image Cropping	7-10
Crop to Pixel Addresses	7-11
Image Size (Number of Pixels)	7-13
Image Brightness (Target White)	7-14
JPEG Image Options	7-14
JPEG Target File Size	7-15
JPEG Quality and Size Value	7-15
Image Enhancement	7-16
Image File Format Selector	7-17
Image Rotation	7-18
Bits Per Pixel	7-19
Signature Capture	7-20
Signature Capture File Format Selector	7-21
Signature Capture Bits Per Pixel	7-22

Signature Capture Width	7-23
Signature Capture Height	7-23
Signature Capture JPEG Quality	7-24
Video View Finder	7-24
Video View Finder Image Size	7-25

Chapter 8: USB Interface

Introduction	8-1
Connecting a USB Interface	8-1
Connecting DS3678 to USB Interface	8-2
Connecting DS3608 to USB Interface	8-3
USB Parameter Defaults	8-4
USB Host Parameter	8-5
USB Device Type	8-5
Symbol Native API (SNAPI) Status Handshaking	8-8
USB Keystroke Delay	8-9
USB CAPS Lock Override	8-9
USB Ignore Unknown Characters	8-10
USB Convert Unknown to Code 39	8-10
Emulate Keypad	8-11
Emulate Keypad with Leading Zero	8-11
Quick Keypad Emulation	8-12
USB Keyboard FN 1 Substitution	8-12
Function Key Mapping	8-13
Simulated Caps Lock	8-13
Convert Case	8-14
USB Static CDC	8-15
Optional USB Parameters	8-16
Ignore Beep	8-16
Ignore Bar Code Configuration	8-16
USB Polling Interval	8-17
USB Fast HID	8-19
IBM Specification Version	8-19
ASCII Character Set for USB	8-20

Chapter 9: SSI Interface

Introduction	9-1
Communications	9-1
SSI Transactions	9-3
General Data Transactions	9-3
Transfer of Decode Data	9-4
Communication Summary	9-5
RTS/CTS Lines	9-5
ACK/NAK Option	9-5
Number of Data Bits	9-5
Serial Response Time-out	9-6
Retries	9-6
Baud Rate, Stop Bits, Parity, Response Time-out, ACK/NAK Handshake	9-6
Errors	9-6

Things to Remember When Using SSI Communication	9-6
Using Time Delay to Low Power Mode with SSI	9-7
Encapsulation of RSM Commands/Responses over SSI	9-8
Command Structure	9-8
Response Structure	9-8
Example Transaction	9-9
Simple Serial Interface Default Parameters	9-10
SSI Host Parameters	9-11
Select SSI Host	9-11
Baud Rate	9-12
Parity	9-13
Check Parity	9-14
Stop Bits	9-15
Software Handshaking	9-16
Host RTS Line State	9-17
Decode Data Packet Format	9-17
Host Serial Response Time-out	9-19
Host Character Time-out	9-20
Multipacket Option	9-21
Interpacket Delay	9-22
Event Reporting	9-23
Decode Event	9-23
Boot Up Event	9-24
Parameter Event	9-24

Chapter 10: RS-232 Interface

Introduction	10-1
Connecting an RS-232 Interface	10-2
Connecting DS3678 to RS-232 Interface	10-2
Connecting DS3608 to USB Interface	10-3
RS-232 Parameter Defaults	10-4
RS-232 Host Parameters	10-5
RS-232 Host Types	10-7
Baud Rate	10-10
Parity	10-11
Stop Bit Select	10-12
Data Bits	10-12
Check Receive Errors	10-13
Hardware Handshaking	10-13
Software Handshaking	10-15
Host Serial Response Time-out	10-17
RTS Line State	10-18
Intercharacter Delay	10-18
Nixdorf Beep/LED Options	10-19
Ignore Unknown Characters	10-20
Beep on <BEL>	10-20
Datalogic Host Format	10-21
Datalogic Supported Commands	10-22
ASCII Character Set for RS-232	10-22

Chapter 11: IBM Interface

Introduction	11-1
Connecting to an IBM 468X/469X Host	11-2
Connecting DS3678 to an IBM 468X/469X Host	11-2
Connecting DS3608 to an IBM 468X/469X Host	11-3
IBM Parameter Defaults	11-4
IBM 468X/469X Host Parameters	11-5
Port Address	11-5
Convert Unknown to Code 39	11-6
RS-485 Beep Directive	11-6
RS-485 Bar Code Configuration Directive	11-7
IBM-485 Specification Version	11-7

Chapter 12: Keyboard Wedge Interface

Introduction	12-1
Connecting a Keyboard Wedge Interface	12-2
Connecting DS3678 to a Keyboard Wedge Interface	12-2
Connecting DS3608 to a Keyboard Wedge Interface	12-3
Keyboard Wedge Parameter Defaults	12-4
Keyboard Wedge Host Parameters	12-5
Keyboard Wedge Host Types	12-5
Ignore Unknown Characters	12-5
Keystroke Delay	12-6
Intra-Keystroke Delay	12-6
Alternate Numeric Keypad Emulation	12-7
Quick Keypad Emulation	12-7
Simulated Caps Lock	12-8
Caps Lock Override	12-8
Convert Wedge Case	12-9
Function Key Mapping	12-9
FN1 Substitution	12-10
Send Make and Break	12-10
Keyboard Maps	12-11
ASCII Character Set for Keyboard Wedge	12-11

Chapter 13: Symbologies

Introduction	13-1
Scanning Sequence Examples	13-1
Errors While Scanning	13-2
Symbology Parameter Defaults	13-2
Enable/Disable All Code Types	13-8
UPC/EAN	13-9
Enable/Disable UPC-A	13-9
Enable/Disable UPC-E	13-9
Enable/Disable UPC-E1	13-10
Enable/Disable EAN-8/JAN-8	13-10
Enable/Disable EAN-13/JAN-13	13-11
Enable/Disable Bookland EAN	13-11

Decode UPC/EAN/JAN Supplementals	13-12
User-Programmable Supplementals	13-15
UPC/EAN/JAN Supplemental Redundancy	13-15
UPC/EAN/JAN Supplemental AIM ID Format	13-16
UPC Reduced Quiet Zone	13-17
Transmit UPC-A Check Digit	13-17
Transmit UPC-E Check Digit	13-18
Transmit UPC-E1 Check Digit	13-18
UPC-A Preamble	13-19
UPC-E Preamble	13-20
UPC-E1 Preamble	13-21
Convert UPC-E to UPC-A	13-22
Convert UPC-E1 to UPC-A	13-22
EAN-8/JAN-8 Extend	13-23
Bookland ISBN Format	13-23
UCC Coupon Extended Code	13-24
Coupon Report	13-25
ISSN EAN	13-25
Code 128	13-26
Enable/Disable Code 128	13-26
Set Lengths for Code 128	13-27
Enable/Disable GS1-128 (formerly UCC/EAN-128)	13-29
Enable/Disable ISBT 128	13-29
ISBT Concatenation	13-30
Check ISBT Table	13-31
ISBT Concatenation Redundancy	13-31
Code 128 Security Level	13-32
Code 128 Reduced Quiet Zone	13-33
Ignore Code 128 <FNC4>	13-33
Code 39	13-34
Enable/Disable Code 39	13-34
Enable/Disable Trioptic Code 39	13-34
Convert Code 39 to Code 32	13-35
Code 32 Prefix	13-35
Set Lengths for Code 39	13-36
Code 39 Check Digit Verification	13-37
Transmit Code 39 Check Digit	13-37
Code 39 Full ASCII Conversion	13-38
Code 39 Security Level	13-39
Code 39 Reduced Quiet Zone	13-40
Code 93	13-40
Enable/Disable Code 93	13-40
Set Lengths for Code 93	13-41
Code 11	13-42
Code 11	13-42
Set Lengths for Code 11	13-43
Code 11 Check Digit Verification	13-44
Transmit Code 11 Check Digits	13-45
Interleaved 2 of 5 (ITF)	13-45
Enable/Disable Interleaved 2 of 5	13-45
Set Lengths for Interleaved 2 of 5	13-46

I 2 of 5 Check Digit Verification	13-47
Transmit I 2 of 5 Check Digit	13-48
Convert I 2 of 5 to EAN-13	13-48
I 2 of 5 Security Level	13-49
I 2 of 5 Reduced Quiet Zone	13-50
Discrete 2 of 5 (DTF)	13-50
Enable/Disable Discrete 2 of 5	13-50
Set Lengths for Discrete 2 of 5	13-51
Codabar (NW - 7)	13-52
Enable/Disable Codabar	13-52
Set Lengths for Codabar	13-53
CLSI Editing	13-55
NOTIS Editing	13-55
Codabar Security Level	13-56
Codabar Upper or Lower Case Start/Stop Characters Detection	13-58
Codabar Mod 16 Check Digit Verification	13-58
Transmit Codabar Check Digit	13-59
MSI	13-60
Enable/Disable MSI	13-60
Set Lengths for MSI	13-61
MSI Check Digits	13-62
Transmit MSI Check Digit(s)	13-63
MSI Check Digit Algorithm	13-64
MSI Reduced Quiet Zone	13-64
Chinese 2 of 5	13-65
Enable/Disable Chinese 2 of 5	13-65
Matrix 2 of 5	13-66
Enable/Disable Matrix 2 of 5	13-66
Set Lengths for Matrix 2 of 5	13-67
Matrix 2 of 5 Check Digit	13-68
Transmit Matrix 2 of 5 Check Digit	13-68
Korean 3 of 5	13-69
Enable/Disable Korean 3 of 5	13-69
Inverse 1D	13-70
GS1 DataBar	13-71
GS1 DataBar-14	13-71
GS1 DataBar Limited	13-71
GS1 DataBar Expanded	13-72
Convert GS1 DataBar to UPC/EAN	13-72
GS1 DataBar Security Level	13-73
GS1 DataBar Limited Margin Check	13-74
Composite	13-75
Composite CC-C	13-75
Composite CC-A/B	13-75
Composite TLC-39	13-76
Composite Inverse	13-77
UPC Composite Mode	13-78
Composite Beep Mode	13-79
GS1-128 Emulation Mode for UCC/EAN Composite Codes	13-79
2D Symbolologies	13-80
Enable/Disable PDF417	13-80

Enable/Disable MicroPDF417	13-80
Code 128 Emulation	13-81
Data Matrix	13-82
GS1 Data Matrix	13-82
Data Matrix Inverse	13-83
Maxicode	13-84
QR Code	13-84
GS1 QR	13-85
MicroQR	13-85
Linked QR Mode	13-86
Aztec	13-87
Aztec Inverse	13-88
Han Xin	13-89
Han Xin Inverse	13-89
Grid Matrix	13-90
Grid Matrix Inverse	13-91
Grid Matrix Mirrored	13-92
DotCode	13-93
DotCode Inverse	13-94
DotCode Mirrored	13-95
DotCode Prioritize	13-96
Postal Codes	13-97
US Postnet	13-97
US Planet	13-97
Transmit US Postal Check Digit	13-98
UK Postal	13-98
Transmit UK Postal Check Digit	13-99
Japan Postal	13-99
Australia Post	13-100
Australia Post Format	13-101
Netherlands KIX Code	13-102
USPS 4CB/One Code/Intelligent Mail	13-102
UPU FICS Postal	13-103
Mailmark	13-103
Symbology-Specific Security Levels	13-104
Redundancy Level	13-104
Security Level	13-106
1D Quiet Zone Level	13-107
Intercharacter Gap Size	13-108
Report Version	13-108
Macro PDF Features	13-109
Flush Macro Buffer	13-109
Abort Macro PDF Entry	13-109

Chapter 14: Intelligent Document Capture

Introduction	14-1
The IDC Process	14-1
Bar Code Acceptance Test	14-2
Capture Region Determination	14-2
Image Post Processing	14-3

Data Transmission	14-3
PC Application and Programming Support	14-3
Parameters	14-4
IDC Operating Mode	14-5
IDC Symbology	14-6
IDC X Coordinate	14-7
IDC Y Coordinate	14-7
IDC Width	14-8
IDC Height	14-8
IDC Aspect	14-9
IDC File Format Selector	14-10
IDC Bits Per Pixel	14-11
IDC JPEG Quality	14-12
IDC Find Box Outline	14-12
IDC Minimum Text Length	14-13
IDC Maximum Text Length	14-14
IDC Captured Image Brighten	14-15
IDC Captured Image Sharpen	14-16
IDC Border Type	14-17
IDC Delay Time	14-18
IDC Zoom Limit	14-18
IDC Maximum Rotation	14-19
Quick Start	14-20
Sample IDC Setup	14-20
IDC Demonstrations	14-21
Other Suggestions	14-22
Quick Start Form	14-22

Chapter 15: Digimarc Barcode

Introduction	15-1
Digimarc Symbology	15-1
Picklist	15-1
Digimarc Digital Watermarks	15-2

Chapter 16: Data Formatting: ADF, MDF, Preferred Symbol

Introduction	16-1
Advanced Data Formatting (ADF)	16-1
Multicode Data Formatting (MDF)	16-1
MDF in Hands-Free Mode	16-2
MDF Best Practices	16-3
Preferred Symbol	16-4

Chapter 17: OCR Programming

Introduction	17-1
OCR Programming Parameters	17-3
Enable/Disable OCR-A	17-3
OCR-A Variant	17-4

- Enable/Disable OCR-B 17-6
- OCR-B Variant 17-7
- Enable/Disable MICR E13B 17-11
- Enable/Disable US Currency Serial Number 17-12
- OCR Orientation 17-12
- OCR Lines 17-14
- OCR Minimum Characters 17-14
- OCR Maximum Characters 17-15
- OCR Subset 17-15
- OCR Quiet Zone 17-16
- OCR Template 17-17
- OCR Check Digit Modulus 17-27
- OCR Check Digit Multiplier 17-28
- OCR Check Digit Validation 17-29
- Inverse OCR 17-34
- OCR Redundancy 17-35

Appendix A: Standard Default Parameters

Appendix B: Country Codes

- Introduction B-1
- USB and Keyboard Wedge Country Keyboard Types (Country Codes) B-2

Appendix C: Country Code Pages

- Introduction C-1
- Country Code Page Defaults C-1
- Country Code Page Bar Codes C-5

Appendix D: CJK Decode Control

- Introduction D-1
- CJK Control Parameters D-2
 - Unicode Output Control D-2
 - CJK Output Method to Windows Host D-3
 - Non-CJK UTF Bar Code Output D-5
- Unicode/CJK Decode Setup with Windows Host D-7
 - Setting Up the Windows Registry Table for Unicode Universal Output D-7
 - Adding CJK IME on Windows D-7
 - Selecting the Simplified Chinese Input Method on the Host D-8
 - Selecting the Traditional Chinese Input Method on the Host D-9

Appendix E: Programming Reference

- Symbol Code Identifiers E-1
- AIM Code Identifiers E-3

Appendix F: Sample Bar Codes

- Code 39 F-1

UPC/EAN	F-1
UPC-A, 100%	F-1
EAN-13, 100%	F-2
Code 128	F-2
Interleaved 2 of 5	F-2
GS1 DataBar-14	F-3
PDF417	F-3
Data Matrix	F-3
Maxicode	F-4
QR Code	F-4
US Postnet	F-4
UK Postal	F-4

Appendix G: Alphanumeric Bar Codes

Alphanumeric Bar Codes	G-1
------------------------------	-----

Appendix H: Numeric Bar Codes

Numeric Bar Codes	H-1
Cancel	H-2

Appendix I: ASCII Character Sets

Appendix J: Communication Protocol Functionality

Functionality Supported via Communication (Cable) Interface	J-1
---	-----

Appendix K: Signature Capture Code

Introduction	K-1
Code Structure	K-1
Signature Capture Area	K-1
CapCode Pattern Structure	K-2
Start / Stop Patterns	K-2
Dimensions	K-3
Data Format	K-3
Additional Capabilities	K-4
Signature Boxes	K-4

Appendix L: Non-Parameter Attributes

Introduction	L-1
Attributes	L-1
Model Number	L-1
Serial Number	L-1
Date of Manufacture	L-2
Date of First Programming	L-2
Configuration Filename	L-2
Beeper/LED	L-3
Parameter Defaults	L-4

Beep on Next Bootup L-4
Reboot L-4
Host Trigger Session L-4
Firmware Version L-5
Scankit Version L-5
ImageKit Version L-5

Index

ABOUT THIS GUIDE

Introduction

The *DS36X8 Product Reference Guide* provides general instructions for setting up, operating, maintaining, and troubleshooting the cordless DS3678 and corded DS3608 digital scanners.

Configurations

DS3678 Configurations

This guide includes the following cordless DS3678 digital scanner configurations:

Configuration	Description
DS3678-XR6F003VTNA	DS3678-XR: TAA, Rugged, Area Imager, Extended Range (SE58), Cordless, FIPS, Green Laser Aimer, Industrial Green, Vibration Motor
DS3678-XR6F003VZCN	DS3678-XR: Rugged, Area Imager, Extended Range (SE58), Cordless, FIPS, Green Laser Aimer, Industrial Green, Vibration Motor - China Only
DS3678-XR6F003VZK	DS3678-XR: Rugged, Area Imager, Extended Range (SE58), Cordless, FIPS, Green Laser Aimer, Industrial Green, Vibration Motor - India & Korea
DS3678-XR6F003VZWW	DS3678-XR: Rugged, Area Imager, Extended Range (SE58), Cordless, FIPS, Green Laser Aimer, Industrial Green, Vibration Motor
DS3678-HD2F003VZWW	Rugged, Area Imager, High Density, Cordless, Industrial Green, Vibration Motor
DS3678-HD2F003VKWW	Keypad and Display, Rugged, Area Imager, High Density, Cordless, FIPS, Industrial Green, Vibration

Configuration	Description
DS3678-HD2F003VZCN	Rugged, Area Imager, High Density, Cordless, Industrial Green, Vibration Motor, China Only
DS3678-HD2F003VZK	Rugged, Area Imager, High Density, Cordless, Industrial Green, Vibration Motor, India & Korea
DS3678-HP2F003VZWW	Rugged, Area Imager, High Performance, Cordless, Industrial Green, Vibration Motor
DS3678-HP2F003VZK	Rugged, Area Imager, Extended Range, Cordless, Industrial Green, Vibration Motor, India & Korea
DS3678-HP2F003VZCN	Rugged, Area Imager, Extended Range, Cordless, Industrial Green, Vibration Motor, China Only
DS3678-HP2F003VKK	Keypad and Display, Rugged, Area Imager, Extended Range, Cordless, Industrial Green, Vibration Motor, India & Korea
DS3678-HP2F003VKCN	Keypad and Display, Rugged, Area Imager, Extended Range, Cordless, Industrial Green, Vibration Motor, China Only
DS3678-HP2F003VKWW	Rugged, Area Imager, High Performance, Cordless, FIPS, Industrial Green, Vibration Motor, Keypad, Display
DS3678-SR0F003VZWW	Rugged, Area Imager, Standard Range, Cordless, Industrial Green, Vibration Motor
DS3678-ER2F003VZWW	Rugged, Area Imager, Extended Range, Cordless, Industrial Green, Vibration Motor
DS3678-ER2F003VTNA	TAA, Rugged, Area Imager, Extended Range, Cordless, Industrial Green, Vibration Motor
DS3678-ER2F003VZCN	Rugged, Area Imager, Extended Range, Cordless, Industrial Green, Vibration Motor, China Only
DS3678-ER2F003VZK	Rugged, Area Imager, Extended Range, Cordless, Industrial Green, Vibration Motor, India & Korea
DS3678-ER2FCC3VTNA	TAA, Rugged, Area Imager, Extended Range, Cordless, Industrial Green, Vibration Motor
DS3678-DP2F003VZWW	Rugged, Digital Scanner, Direct Part Marking, Cordless, FIPS, Industrial Green, Vibration Motor
DS3678-DP2F003VTNA	TAA, Rugged, Area Imager, Direct Part Marking, Cordless, FIPS, Industrial Green, Vibration Motor
DS3678-DP2F003VZCN	Rugged, Area Imager, Direct Part Marking, Cordless, FIPS, Industrial Green, Vibration Motor, China Only

Configuration	Description
DS3678-DP2F003VZK	Rugged, Area Imager, Direct Part Marking, Cordless, FIPS, Industrial Green, Vibration Motor, India & Korea
DS3678-DPXF003VZCN	Rugged, Area Imager, Direct Part Marking, Direct Illumination, Cordless, FIPS, Industrial Green, Vibration Motor, China Only
DS3678-DP2FCC3VTNA	TAA, Rugged, Area Imager, Direct Part Marking, Cordless, FIPS, Industrial Green, Vibration Motor
DS3678-DPAF002VZWW	Rugged, Area Imager, Direct Part Mark for Automation, Cordless, FIPS, Gray, Vibration Motor
DS3678-DPAF002VZCN	Rugged, Area Imager, Direct Part Mark, Industrial Focus, Cordless, FIPS, Industrial Green, Vibration Motor, China Only
DS3678-DPAF002VZK	Rugged, Area Imager, Direct Part Mark, Industrial Focus, Cordless, FIPS, Industrial Green, Vibration Motor, India & Korea
DS3678-SR0F003VTNA	TAA, Rugged, Area Imager, Standard Range, DL Parsing, Cordless, FIPS, Industrial Green, Vibration Motor
DS3678-SR0F003VZCN	Rugged, Area Imager, Standard Range, DL Parsing, Cordless, FIPS, Industrial Green, Vibration Motor, China Only
DS3678-SR0F003VZK	Rugged, Area Imager, Standard Range, DL Parsing, Cordless, FIPS, Industrial Green, Vibration Motor, India & Korea
DS3678-SR0F003VZWW	Rugged, Area Imager, Standard Range, DL Parsing, Cordless, FIPS, Industrial Green, Vibration Motor
DS3678-SR0FCC3VTNA	TAA, Rugged, Area Imager, Standard Range, Cordless, FIPS, Industrial Green, Vibration Motor

DS3608 Configurations

This guide includes the following corded DS3608 digital scanner configurations:

Configuration	Description
DS3608-HD20003VZWW	Rugged, Area Imager, High Density, Corded, Industrial Green, Vibration Motor
DS3608-HD20003VZCN	Rugged, Area Imager, High Density, Corded, Industrial Green, Vibration Motor, China Only
DS3608-HD20003VZK	Rugged, Area Imager, High Density, Corded, Industrial Green, Vibration Motor, India & Korea
DS3608-HP20003VZWW	Rugged, Area Imager, High Performance, Corded, Industrial Green, Vibration Motor
DS3608-HP20003VZCN	Rugged, Area Imager, High Performance, Corded, Industrial Green, Vibration Motor, China Only
DS3608-HP20003VZWW	Rugged, Area Imager, High Performance, Corded, Industrial Green, Vibration Motor
DS3608-SR00003VZWW	Rugged, Area Imager, Standard Range, Corded, Industrial Green, Vibration Motor
DS3608-SR00003VTNA	TAA, Rugged, Area Imager, Standard Range, Corded, Industrial Green, Vibration Motor
DS3608-SR00003VZCN	Rugged, Area Imager, Standard Range, Corded, Industrial Green, Vibration Motor, China Only
DS3608-SR00003VZK	Rugged, Area Imager, Standard Range, Corded, Industrial Green, Vibration Motor, India & Korea
DS3608-SR00CC3VTNA	TAA, Rugged, Area Imager, Standard Range, Corded, Industrial Green, Vibration Motor
DS3608-ER20003VZWW	Rugged, Area Imager, Extended Range, Corded, Industrial Green, Vibration Motor
DS3608-ER20003VTNA	TAA, Rugged, Area Imager, Extended Range, Corded, Industrial Green, Vibration Motor
DS3608-ER20003VZCN	Rugged, Area Imager, Extended Range, Corded, Industrial Green, Vibration Motor, China Only
DS3608-ER20003VZK	Rugged, Area Imager, Extended Range, Corded, Industrial Green, Vibration Motor, India & Korea
DS3608-ER20CC3VTNA	TAA, Rugged, Area Imager, Extended Range, Corded, Industrial Green, Vibration Motor
DS3608-DL00003VZWW	Rugged, Area Imager, Standard Range, DL Parsing, Corded, Industrial Green, Vibration Motor
DS3608-DP20003VZWW	Rugged, Area Imager, Direct Part Marking, FIPS, Industrial Green, Vibration Motor
DS3608-DP20CC3VTNA	TAA, Rugged, Area Imager, Direct Part Marking, Corded, Industrial Green, Vibration Motor

Configuration	Description
DS3608-DP20003VTNA	Rugged, Area Imager, Direct Part Marking, Corded, Industrial Green, Vibration Motor
DS3608-DPX0003VZCN	Rugged, Area Imager, Direct Part Marking, Direct Illumination, Corded, Industrial Green, Vibration Motor, China Only
DS3608-DP20003VZK	Rugged, Area Imager, Direct Part Marking, Direct Illumination, Corded, Industrial Green, Vibration Motor, India & Korea
DS3608-DP20003VZCN	Rugged, Area Imager, Direct Part Marking, Corded, Industrial Green, Vibration Motor, China Only
DS3608-DPA0002VZWW	Rugged, Area Imager, Direct Part Mark for Automation, Corded, FIPS, Gray, Vibration Motor
DS3608-DPA0002VZK	Rugged, Area Imager, Direct Part Mark for Automation, Corded, FIPS, Gray, Vibration Motor, India & Korea
DS3608-XR60003VTNA	TAA, Rugged, Area Imager, Extended Range (SE58) , Corded, Green Laser Aimer Industrial Green, Vibration Motor
DS3608-XR60003VZCN	Rugged, Area Imager, Extended Range (SE58), Corded, Green Laser Aimer, Industrial Green, Vibration Motor - China Only
DS3608-XR60003VZK	Rugged, Area Imager, Extended Range (SE58), Corded, Green Laser Aimer, Industrial Green, Vibration Motor - India & Korea
DS3608-XR60003VZWW	Rugged, Area Imager, Extended Range (SE58), Corded, Green Laser Aimer, Industrial Green, Vibration Motor

Related Product Line Configurations



CAUTION DO NOT use cables designed for the LS35X8 and DS35X8 scanners as they are not compatible with the DS36X8 digital scanner.



CAUTION When using the power on Pin 9 RS-232 cables, be sure the host that these cables are plugged into is supplying 5V only. Some vehicle mounted computers have the option of supplying either 5V or 12V on Pin 9. Be sure the option is set to 5V otherwise a corded scanner will sustain damage and a cradle does not operate (not damaged).



NOTE Check Solution Builder for:
 - additional information regarding all available accessories
 - the latest available configurations.

Related DS3678 Product Line Configurations

The product configurations related to the cordless DS3678 digital scanner are as follows:

Product	Part Number	Description
Accessories		
Cradle	STB3678-C100F3WW	Standard Cradle, Charger, Bluetooth, Multiple Interface
Cradle - Forklift	FLB3678-C100F3WW	IP65 Sealed Cradle, Charger, Bluetooth, Multiple Interface
Mounting Plate	21-84259-01	Mounting plate for FLB3678
Battery	BTRY-36IAB0E-00	Spare Battery
Battery Charger	SAC3600-4001CR	4 Slot Battery Charger
Tool Balancer Pulley	50-15400-031	Pulley: Tool Balancer Pulley
Clip on Belt Holster	11-59382-01	Holder: Clip on Belt
Fork Lift Holder	21-52612-01R	Holder: Fork Lift
Lanyard	50-12500-066	Lanyard Strap

Product	Part Number	Description
Universal Cables		
Shielded USB	CBA-UF2-C12ZAR	Shielded USB: Series A Locking Connector for VC70, 12', Coiled, -30°C
	CBA-U42-S07PAR	Shielded USB: Series A Connector, 7ft. (2.8m), Straight, 12V (Requires 12V Power Supply)
	CBA-U46-S07ZAR	Shielded USB: Series A Connector, 7ft. (2m), Straight, BC 1.2
	CBA-U47-S15ZAR	Shielded USB: Series A Connector, 15ft. (4.6m), Straight, BC 1.2
	CBA-U44-S15PAR	Shielded USB: Series A Connector, 15ft. (4.6m), Straight, 12V
	CBA-U45-S15ZAR	Shielded USB: Power Plus Connector, 15ft. (4.6m), Straight, 12V
	CBA-U43-S07ZAR	Shielded USB: Power Plus Connector, 7ft. (2.8m), Straight, 12V
	CBA-UF0-S07PAR	Cable - Shielded USB: Series A Connector, 7ft. (2m), Straight, 12V (Requires 12V Power Supply), Low Temp -30°C
	CBA-UF1-S07ZAR	Cable - Shielded USB: Series A Connector, 7ft. (2m), Straight, BC 1.2 (High Current), -30°C
	CBA-UF3-C09ZAR	Cable - Shielded USB: Amphenol Threaded Circular Connector for VC5090, 9ft (2.8m) Coiled
	CBA-UF4-C09ZAR	Cable - USB, RS232 "Y" Power Stealer, 9ft Coiled, -30°C
	CBA-UF5-C09ZAR	Cable - USB, RS232 "Y" Power Stealer, 9ft Coiled, DS3600 to VC5090, -30°C
	CBA-UF6-C12ZAR	Cable - Shielded USB: Series A, 12', Coiled, BC1.2 (High Current), -30°C
Keyboard Wedge	CBA-K63-S07PAR	Auto-Host Detect - Keyboard Wedge: 7ft. (2m) Straight, PS/2 Power Port, 12V (Requires 12V Power Supply)
	CBA-K65-S15PAR	Auto-Host Detect - Keyboard Wedge: 15ft. (4.6m) Straight, PS/2 Power Port, 12V (Requires 12V Power Supply)
IBM	CBA-M65-S07ZAR	Auto-Host Detect - IBM: 468x/9x, 7ft (2m) Straight, Port 9B, 12V
	CBA-M66-S15ZAR	Auto-Host Detect - IBM: 468x/9x, 15ft. (4.6m) Straight, Port 9B, 12V
RS-232	CBA-R07-S07PAR	RS232: DB9 Female Connector, 7 ft. (2m) Straight, TxD on 2, 12V (Requires 12V Power Supply)
	CBA-RF0-S07PAR	RS232: DB9 Female Connector, 7ft. (2.0m) Straight, TxD on 2, 12V (Requires 12V Power Supply), -30°C
	CBA-R21-S15PAR	RS232:DB9 Female Connector, 15ft. (4.6m). TxD on 2, 12V (Requires 12V Power Supply)
	CBA-R71-C09ZAR	RS232:DB9 Female Connector, 9ft. (2.8m), Coiled, Power Pin 9
	CBA-RF1-C09PAR	Cable - RS232: DB9 Female Connector, 9ft. (2.8m) Coiled, TxD on 2, 12V (Requires 12V Power Supply), -30°C
	CBA-RF2-C09ZAR	Cable - RS232: DB9 Female Connector, 9ft (2.8m) Coiled, Power Pin 9, -30°C
	CBA-RF3-C09ZAR	Cable - RS232: DB9 Female Connector, 9ft. (2.8m) Coiled, Power Pin 9, TxD on 2, True Converter, Low Temp -30°C
	CBA-RF4-C09ZAR	Cable - RS232: Amphenol Threaded Circular Connector for VC5090, 9ft (2.8m) Coiled
	CBA-RF5-S07ZAR	Cable - RS232: DB9 Female Connector, 7ft (2.8m) Straight, Power Pin 9, -30°C

Product	Part Number	Description
Power Supplies	PWRS-BGA12V50W0WW	Level VI AC/DC Power Supply (Brick), AC Input: 100-240V, 2.4A. DC Output: 12V, 4.16A, 50W. Requires: DC line cord CBL-DC-451A1-01 and Country specific AC grounded Line Cord
	CBL-DC-451A1-01	DC Line Cord with Filter, used with 3600 Series Level VI AC/DC Power Supply p/n PWR-BGA12V50W0WW
	CBL-DC-375A1-01	DC Line Cord used with Level VI AC/DC Power Supply p/n PWR-BGA12V50W0WW for Four Slot Battery Charger p/n SAC3600-4001CR. (Note: For use with SAC3600-4001CR only. Do not use CBL-DC-375A1-01 with LI/DS36X8 Scanners or STB/FLB3678 cradles.)
	PWRS-14000-251R	Power Supply: 18-75VDC, 12VDC, High
	PWRS-14000-252R	Power Supply: 9-30VDC, 12VDC, Low
	CBL-36-452A-01	Cable Adapter (for use with PWRS-14000-251R and PWRS-14000-252R)
	23844-00-00R	AC Line Cord (for use with PWR-BGA12V50W0WW)

Related DS3608 Product Line Configurations

The product configurations related to the corded DS3608 digital scanner are as follows:

Product	Part Number	Description
Accessories		
Intellistand	STND-AS0036-07	Stand: Adjustable Intellistand, Black
Tool Balancer Pulley	50-15400-031	Pulley: Tool Balancer Pulley
Clip on Belt Holster	11-59382-01	Holder: Clip on Belt
Fork Lift Holder	21-52612-01R	Holder: Fork Lift
Lanyard	50-12500-066	Lanyard Strap

Product	Part Number	Description
Universal Cables		
Shielded USB	CBA-UF2-C12ZAR	Shielded USB: Series A Locking Connector for VC70, 12', Coiled, -30°C
	CBA-U42-S07PAR	Shielded USB: Series A Connector, 7ft. (2.8m), Straight, 12V (Requires 12V Power Supply)
	CBA-U46-S07ZAR	Shielded USB: Series A Connector, 7ft. (2m), Straight, BC 1.2
	CBA-U47-S15ZAR	Shielded USB: Series A Connector, 15ft. (4.6m), Straight, BC 1.2
	CBA-U44-S15PAR	Shielded USB: Series A Connector, 15ft. (4.6m), Straight, 12V
	CBA-U45-S15ZAR	Shielded USB: Power Plus Connector, 15ft. (4.6m), Straight, 12V
	CBA-U43-S07ZAR	Shielded USB: Power Plus Connector, 7ft. (2.8m), Straight, 12V
	CBA-UF0-S07PAR	Cable - Shielded USB: Series A Connector, 7ft. (2m), Straight, 12V (Requires 12V Power Supply), Low Temp -30°C
	CBA-UF1-S07ZAR	Cable - Shielded USB: Series A Connector, 7ft. (2m), Straight, BC 1.2 (High Current), -30°C
	CBA-UF3-C09ZAR	Cable - Shielded USB: Amphenol Threaded Circular Connector for VC5090, 9ft (2.8m) Coiled
	CBA-UF4-C09ZAR	Cable - USB, RS232 "Y" Power Stealer, 9ft Coiled, -30°C
	CBA-UF5-C09ZAR	Cable - USB, RS232 "Y" Power Stealer, 9ft Coiled, DS3600 to VC5090, -30°C
	CBA-UF6-C12ZAR	Cable - Shielded USB: Series A, 12', Coiled, BC1.2 (High Current), -30°C
Keyboard Wedge	CBA-K63-S07PAR	Auto-Host Detect - Keyboard Wedge: 7ft. (2m) Straight, PS/2 Power Port, 12V (Requires 12V Power Supply)
	CBA-K65-S15PAR	Auto-Host Detect - Keyboard Wedge: 15ft. (4.6m) Straight, PS/2 Power Port, 12V (Requires 12V Power Supply)
IBM	CBA-M65-S07ZAR	Auto-Host Detect - IBM: 468x/9x, 7ft (2m) Straight, Port 9B, 12V
	CBA-M66-S15ZAR	Auto-Host Detect - IBM: 468x/9x, 15ft (4.6m) Straight, Port 9B, 12V
RS-232	CBA-R07-S07PAR	RS232: DB9 Female Connector, 7 ft. (2m) Straight, TxD on 2, 12V (Requires 12V Power Supply)
	CBA-RF0-S07PAR	RS232: DB9 Female Connector, 7ft. (2.0m) Straight, TxD on 2, 12V (Requires 12V Power Supply), -30°C
	CBA-R21-S15PAR	RS232: DB9 Female Connector, 15ft. (4.6m) Coiled, TxD on 2, 12V (Requires 12V Power Supply)
	CBA-R71-C09ZAR	RS232: DB9 Female Connector, 9ft. (2.8m) Coiled, Power Pin 9
	CBA-RF1-C09PAR	Cable - RS232: DB9 Female Connector, 9ft. (2.8m) Coiled, TxD on 2, 12V (Requires 12V Power Supply), -30°C
	CBA-RF2-C09ZAR	Cable - RS232: DB9 Female Connector, 9ft (2.8m) Coiled, Power Pin 9, -30°C
	CBA-RF3-C09ZAR	Cable - RS232: DB9 Female Connector, 9ft. (2.8m) Coiled, Power Pin 9, TxD on 2, True Converter, Low Temp -30°C
	CBA-RF4-C09ZAR	Cable - RS232: Amphenol Threaded Circular Connector for VC5090, 9ft (2.8m) Coiled
	CBA-RF5-S07ZAR	Cable - RS232: DB9 Female Connector, 7ft (2.8m) Straight, Power Pin 9, -30°C

Product	Part Number	Description
Power Supplies	PWRS-BGA12V50W0W W	Level VI AC/DC Power Supply (Brick), AC Input: 100-240V, 2.4A. DC Output: 12V, 4.16A, 50W. Requires: DC line cord CBL-DC-451A1-01 and Country specific AC grounded Line Cord
	CBL-DC-451A1-01	DC Line Cord with Filter, used with 3600 Series Level 6 AC/DC Power Supply p/n PWR-BGA12V50W0WW
	PWRS-14000-251R	Power Supply: 18-75VDC, 12VDC, High
	PWRS-14000-252R	Power Supply: 9-30VDC, 12VDC, Low
	CBL-36-452A-01	Cable Adapter (for use with PWRS-14000-251R and PWRS-14000-252R)
	23844-00-00R	AC Line Cord (for use with PWR-BGA12V50W0WW)

Chapter Descriptions

Topics covered in this guide are as follows:

- [Chapter 1, Getting Started](#) provides a product overview, unpacking instructions, and cable connection information.
- [Chapter 2, 123Scan and Software Tools](#) describes the Zebra software tools available for customizing scanner operation.
- [Chapter 3, Data Capture](#) provides beeper and LED definitions, techniques involved in scanning barcodes, general instructions and tips about scanning, and decode ranges.
- [Chapter 4, Maintenance & Technical Specifications](#) provides suggested digital scanner maintenance, troubleshooting, technical specifications, and signal descriptions (pinouts).
- [Chapter 5, Radio Communications](#) provides information about the modes of operation and features available for wireless communication, and includes programming barcodes to configure the cordless digital scanner.
- [Chapter 6, User Preferences & Miscellaneous Options](#) describes each user preference feature and provides programming barcodes for selecting these features.
- [Chapter 7, Imaging Preferences](#) describes imaging preference features and provides programming barcodes for selecting these features.
- [Chapter 8, USB Interface](#) describes how to set up the digital scanner with a USB host.
- [Chapter 9, SSI Interface](#) describes the system requirements of the Simple Serial Interface (SSI), which provides a communications link between Zebra decoders and a serial host.
- [Chapter 10, RS-232 Interface](#) describes how to set up the digital scanner with an RS-232 host.
- [Chapter 11, IBM Interface](#) describes how to set up the digital scanner with an IBM 468X/469X host.
- [Chapter 12, Keyboard Wedge Interface](#) describes how to set up a keyboard wedge interface with the digital scanner.
- [Chapter 13, Symbologies](#) describes all symbology features and provides programming barcodes for selecting these features for the digital scanner.
- [Chapter 14, Intelligent Document Capture](#) describes IDC, an advanced image processing firmware, including IDC functionality, parameter barcodes to control its features, and a quick start procedure.
- [Chapter 15, Digimarc Barcode](#) describes the invisible machine-readable code, and provides barcodes for selecting this code.

- [Chapter 16, Data Formatting: ADF, MDF, Preferred Symbol](#) briefly describes the Zebra features available for customizing scanner operation.
- [Chapter 17, OCR Programming](#) describes how to set up the digital scanner for OCR programming.
- [Appendix A, Standard Default Parameters](#) provides a table of all host devices and scanner defaults.
- [Appendix B, Country Codes](#) provides barcodes for programming the country keyboard type for the USB keyboard (HID) device and the keyboard wedge host.
- [Appendix C, Country Code Pages](#) provides barcodes for selecting code pages for the country keyboard type.
- [Appendix D, CJK Decode Control](#) describes control parameters for Unicode/CJK (Chinese, Japanese, Korean) barcode decode through USB HID Keyboard Emulation mode.
- [Appendix E, Programming Reference](#) provides a table of AIM code identifiers, ASCII character conversions, and keyboard maps.
- [Appendix F, Sample Bar Codes](#) includes sample barcodes of various code types.
- [Appendix G, Alphanumeric Bar Codes](#) includes the barcodes to scan for parameters requiring specific alphanumeric values.
- [Appendix H, Numeric Bar Codes](#) includes the barcodes to scan for parameters requiring specific numeric values.
- [Appendix I, ASCII Character Sets](#) provides ASCII character value tables.
- [Appendix J, Communication Protocol Functionality](#) lists supported scanner functionality by communication protocol.
- [Appendix K, Signature Capture Code](#) describes CapCode, a special pattern that encloses a signature area on a document and allows the scanner to capture a signature.
- [Appendix L, Non-Parameter Attributes](#) defines non-parameter attributes.

Notational Conventions

The following conventions are used in this document:

- *Italics* are used to highlight the following:
 - Chapters and sections in this and related documents
 - Dialog box, window and screen names
 - Drop-down list and list box names
 - Check box and radio button names
- **Bold** text is used to highlight the following:
 - Key names on a keypad
 - Button names on a screen.
- bullets (•) indicate:
 - Action items
 - Lists of alternatives
 - Lists of required steps that are not necessarily sequential
- Sequential lists (e.g., those that describe step-by-step procedures) appear as numbered lists.

- Throughout the programming barcode menus, asterisks (*) are used to denote default parameter settings.



* Indicates Default — * HID Keyboard Emulation — Feature/Option

Related Documents

- *DS3678 Quick Start Guide*, p/n MN002648Axx - provides general information for getting started with the DS3678 digital scanner, and includes basic set up and operation instructions.
- *DS3608 Quick Start Guide*, p/n MN002257Axx - provides general information for getting started with the DS3608 digital scanner, and includes basic set up and operation instructions.
- *STB3678 Cradle Quick Reference Guide*, p/n MN002336Axx - provides information on installing and operating STB3678 cradles.
- *FLB3678 Cradle Quick Reference Guide*, p/n MN002334Axx - provides information on installing and operating FLB3678 cradles.
- *Advanced Data Formatting Programmer Guide*, p/n 72E-69680-xx - provides information on ADF, a means of customizing data before transmission to a host.
- *MDF and Preferred Symbol User Guide*, p/n MN-002895-xx - provides information on Multicode Data Formatting and Preferred Symbol Prioritization.
- *Attribute Data Dictionary*, p/n 72E-149786-xx - defines attribute numbers (device configuration parameters, monitored data, and born-on information) and describes management of various attribute domains for barcode scanners and OEM engines.

For the latest version of this guide and all guides, go to: <http://zebra.com/support>.

Service Information

If you have a problem using the equipment, contact your facility's technical or systems support. If there is a problem with the equipment, they will contact the Customer Support Center at: <http://zebra.com/support>.

When contacting support, please have the following information available:

- Serial number of the unit
- Model number or product name
- Software type and version number

Zebra responds to calls by e-mail, telephone or fax within the time limits set forth in service agreements.

If your problem cannot be solved by support, you may need to return your equipment for servicing and will be given specific directions. Zebra is not responsible for any damages incurred during shipment if the approved shipping container is not used. Shipping the units improperly can possibly void the warranty.

If you purchased your business product from a Zebra business partner, please contact that business partner for support.

Provide Documentation Feedback

If you have comments, questions, or suggestions about this guide, send an email to EVM-Techdocs@zebra.com.

CHAPTER 1 GETTING STARTED

Introduction

The cordless DS36X8 combines superior 1D and 2D omnidirectional barcode scanning performance and advanced ergonomics in a lightweight design. The digital scanner ensures comfort and ease of use for extended periods of time.

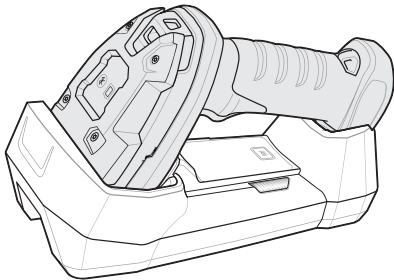

Figure 1-1 *DS3678 Cordless Digital Scanner*

The corded DS3608 combines superior 1D and 2D omnidirectional barcode scanning and transfer with a light-weight, Hands-free/Hand-held design. The digital scanner's Intellistand seamlessly accommodates both counter top and Hand-held use.

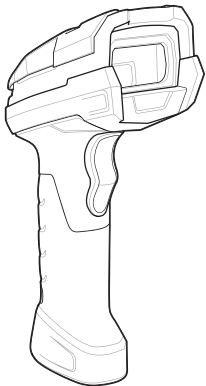

Figure 1-2 *DS3608 Corded Digital Scanner*

The DS36X8 digital scanner supports:

- USB connection to a host. The digital scanner autodetects a USB host and defaults to the HID keyboard interface type. Select other USB interface types by scanning programming barcode menus. This interface supports the following international keyboards (for Windows® environment): North America, German, French, French Canadian, Spanish, Italian, Swedish, UK English, Portuguese-Brazilian, and Japanese.
- Standard RS-232 connection to a host. Scan barcode menus to set up communication of the digital scanner with the host.
- Connection to IBM 468X/469X hosts. Scan barcode menus to set up communication of the digital scanner with the IBM terminal.
- Keyboard Wedge connection to a host. The host interprets scanned data as keystrokes. Scan barcode menus to set up communication of the digital scanner with the host. This interface supports the following international keyboards (for Windows® environment): North America, German, French International, French Canadian, French Belgian, Spanish, Italian, Swedish, UK English, Brazilian-Portuguese and Japanese.

See [Appendix B, Country Codes](#) for instructions on programming the keyboard to interface with a USB or keyboard wedge host

- Configuration via 123Scan².

✓ **NOTE** For a list of supported scanner functionality by communication protocol, see [Appendix J, Communication Protocol Functionality](#).

Unpacking

Remove the digital scanner from its packing and inspect it for damage. If the scanner was damaged in transit, contact support. See [page xxxiv](#) for information. **KEEP THE PACKING**. It is the approved shipping container; use this to return the equipment for servicing.

DS3678 Cordless Digital Scanner

DS3678 Parts

- ✓ **NOTE** Refer to the DS3678-HP PRG Supplement at zebra.com/support regarding DS3678-HP with Keypad & Display parts and features.

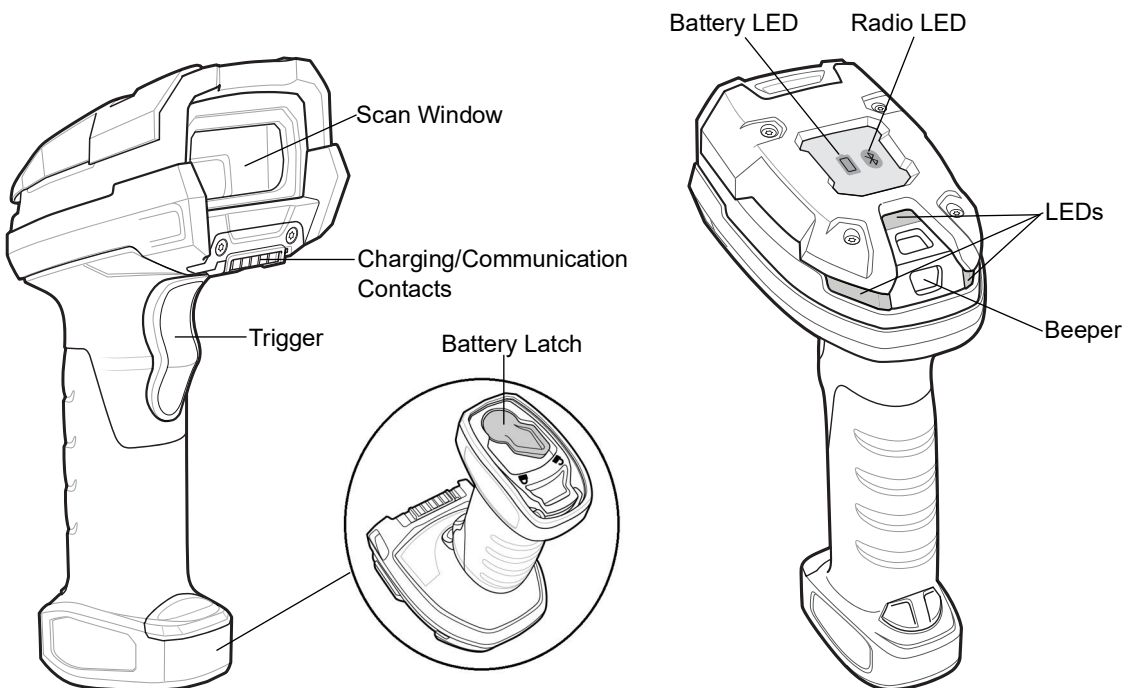

Figure 1-3 DS3678 Parts

The Cradle

The cradles serve as a charger, radio communication interface, and host communication interface for the DS3678 cordless digital scanner. There are two versions of the cradle:

- The **STB3678 cordless cradle** sits on a desktop or mounts on a wall, and charges the DS3678 cordless digital scanner. This cradle also provides host communication by receiving scanner data via a Bluetooth radio, and sending that data to the host through an attached cable. An external power supply or a powered host cable provides power to the cradle.
- The **FLB3678 cordless cradle** charges the DS3678 cordless digital scanner, and provides host communication by receiving scanner data via a Bluetooth radio, and sending that data to the host through an attached cable. The cradle attaches to a mounting bracket using three isolators, and the bracket then mounts on the forklift surface. A portable power supply on the forklift or a host cable provides power to the cradle.

DO NOT use cradles and cables designed for the LS3578 and DS3578 scanners as they are not compatible with the DS3678 digital scanner and cradle.

- ✓ **NOTE** For more information about communication between the digital scanner, cradle, and host, see [Chapter 5, Radio Communications](#).

1 - 4 DS36X8 Digital Scanner Product Reference Guide

For more information about mounting options and procedures, refer to the documentation included with the cradle.

Cradle Parts

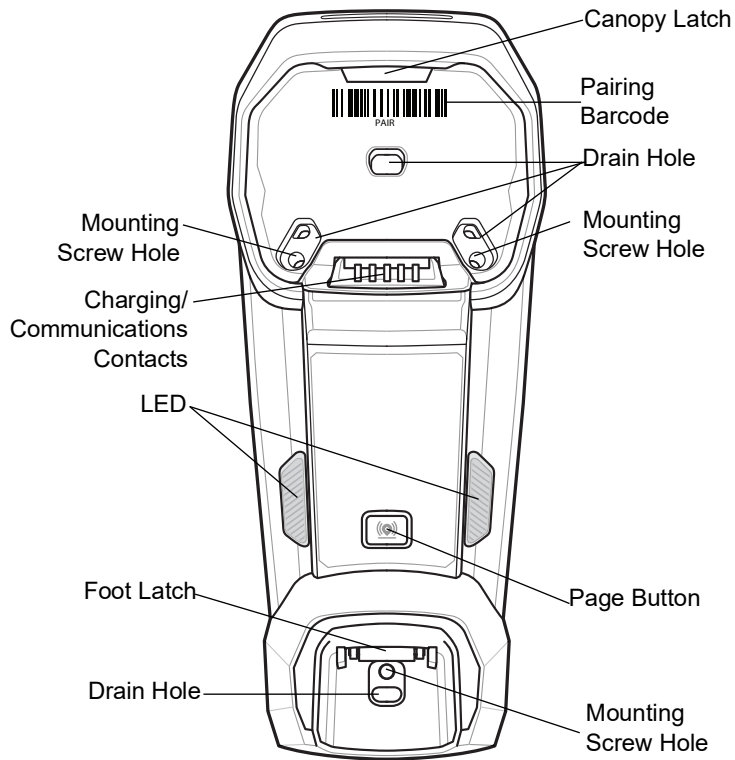

Figure 1-4 *Cradle Front View*

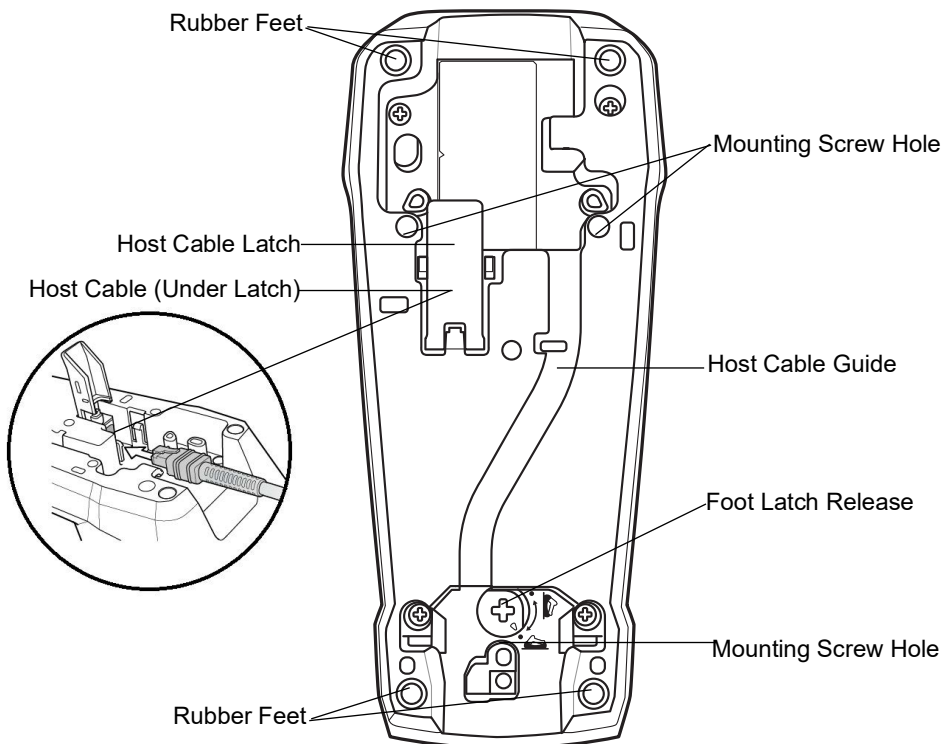

Figure 1-5 *Cradle Back View*

Connecting the Cradle

- ✓ **NOTE** Connect the interface cable and power supply (if necessary) in the following order to ensure proper operation of the digital scanner and cradle.

To connect the STB3678/FLB3678 cradles:

1. Connect the appropriate cable to the power supply and an AC power source, if necessary.
2. Insert the interface cable into the host port.
3. Lift the latch and connect the interface cable into the cradle's host port and then close the latch. See [Figure 1-6](#).
4. If applicable, thread the interface cable over the cable support hook and run the host cable into the cable groove.
5. Pair the digital scanner to the cradle either by inserting it in the cradle (if pair on contacts is enabled), or by scanning the pairing barcode.
6. If necessary, scan the appropriate host barcode (for non-autodetected interfaces). See the specific host chapter.

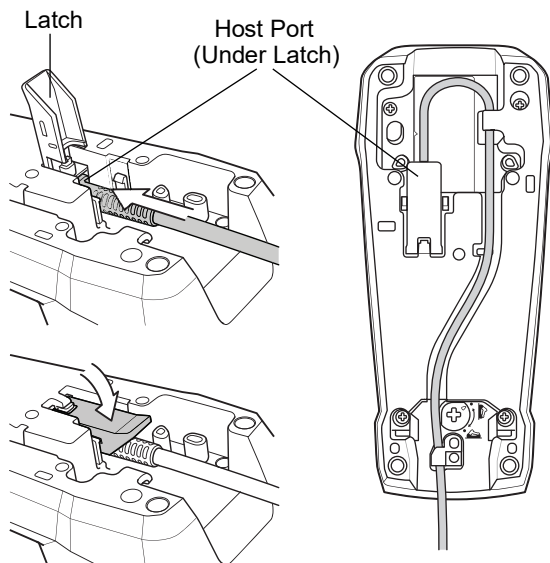

Figure 1-6 *Connecting the Cables to the Cradle*

- ✓ **NOTE** Always disconnect the DC power supply BEFORE disconnecting the cable to the host end or the cradle may not recognize the new host.
- ✓ **NOTE** Different cables are required for different hosts. The connectors illustrated in each host chapter are examples only. The connectors may be different from those illustrated, but the steps to connect the digital scanner remain the same.

Supplying Power to the Cradle

The cradle receives power from one of two sources:

- An external power supply.
- When connected to the host through an interface cable that supplies power.

The cradle detects whether the host or the external supply is supplying power. It always draws power from the external supply when available, regardless of the presence of power from a host.

✓ **NOTE** Supplying power from a USB host may take longer to charge the digital scanner.

Mounting the Cradle

For information on mounting the cradle, refer to the documentation included with the cradle.

DS3678 Battery

Battery Statistics Capabilities

The DS3678 cordless scanner is equipped with PowerPrecision+ batteries. These intelligent batteries have the integrated technology required to collect the detailed real-time battery metrics needed to maximize useful battery life and ensure every battery is healthy and able to hold a full charge.

The PowerPrecision+ batteries support the following remote management functionality:

- Battery Asset Information
 - Manufacture Date of Battery
 - Serial Number of Battery
 - Model Number of Battery
 - Firmware Version of Battery
 - Design Capacity
- Battery Life Statistics
 - State of Health Meter
 - Charge Cycles Consumed
- Battery Status (at Time of Poll)
 - State of Charge
 - Remaining Capacity
 - Charge Status
 - Remaining Time to Complete Charging
 - Battery Voltage / Current
- Battery Temperature
 - Present / Highest / Lowest

Battery statistic data can be viewed in 123Scan² at zebra.com/123Scan, or by using a third party remote management console.

To view statistics using 123Scan²:

1. Connect a PowerPrecision+ enabled cordless scanner to 123Scan² using a USB connected cradle.
2. Open 123Scan² and select the **Start** tab.
3. Select **Actions** > **View Statistics from USB Scanner**. Your cordless scanner's statistics are visible under the Battery Diagnostic heading.

For detailed PowerPrecision+ battery information, go to: <http://zebra.com/powerprecision>.

Inserting the DS3678 Battery

- ✓ **NOTE** Batteries are shipped in an **Off** mode and do not power the scanner. After inserting a new battery into the DS3678 digital scanner, you must insert the scanner into a cradle for the battery to turn **On**.
Alternatively, the battery can be placed in the four slot spare battery charger to charge and then inserted in the scanner for immediate use.

The battery resides in a chamber in the digital scanner handle. To insert the battery:

1. Lightly press down and slide the locking lever counterclockwise to unlock and release the battery door.
2. Open the battery door.
3. If a battery is already installed, turn the digital scanner upright to slide the battery out.
4. Slide the new battery into the chamber, with the rounded side toward the back and the contacts facing into the chamber.

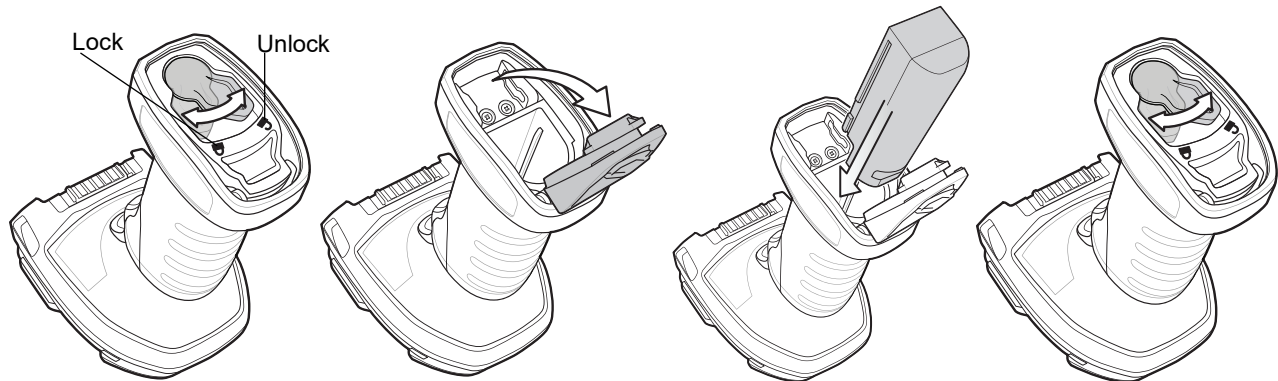

Figure 1-7 *Inserting the Battery*

5. Close the battery door.
6. Lightly press down and slide the locking lever clockwise to lock the battery door.
7. If using a brand new battery, insert the scanner into a cradle to turn the battery on.

Removing the DS3678 Battery

To remove the battery:

1. Lightly press down and slide the locking lever counterclockwise to unlock the battery door.
2. Open the battery door.
3. Turn the digital scanner upright to slide the battery out.

Charging the DS3678 Battery

When using a new battery in the DS3678, the battery requires a charge to be enabled. Insert the battery (see [Inserting the DS3678 Battery on page 1-8](#)) in the DS3678 and place the DS3678 in the STB/FLB3678 cradle (see [Inserting the DS3678 Scanner in the Cradle on page 1-10](#)).

The battery begins charging when the cradle's LED indicator starts blinking amber. The DS3678's battery has completed a charge when the cradle's LED indicator is solid green. A complete charge of a fully discharged battery can take up to three hours using external power and up to ten hours using USB power over the USB interface cable.

See [DS3678 Beeper and LED Definitions on page 3-1](#) for detailed LED indicator information.



CAUTION To avoid a battery temperature fault, always charge the battery in the digital scanner within the recommended temperature of 32° to 104° F (0° to 40° C) nominal, 41° to 95° F (5° to 35° C) ideal.

Shutting Off the Battery

Scan the Battery Off barcode below to shut off the battery for long term storage or shipping. Pull the digital scanner trigger to turn on the battery.



Battery Off



NOTE Always scan the Battery Off barcode in hand-held mode. Also see [Battery Preservation Mode on page 6-20](#) for additional battery features.

Inserting the DS3678 Scanner in the Cradle

To insert the digital scanner in the cradle:

1. Insert the digital scanner into the cradle top first.
2. Push the handle until it clicks into place, engaging the contacts in the cradle and digital scanner.

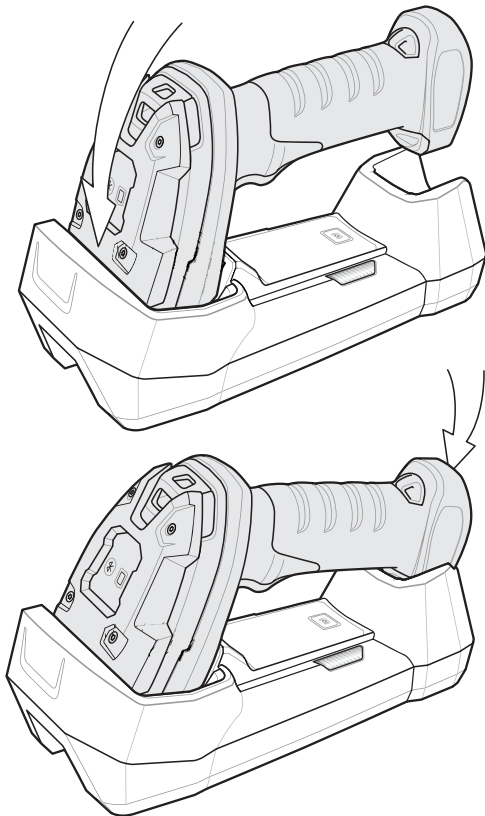

Figure 1-8 *Inserting the Scanner in the Cradle*

Sending Data to the Host Computer

The cradle receives data from the digital scanner via a wireless radio connection and transmits it to the host computer via the host cable. The digital scanner and cradle must be paired for successful wireless communication.

Pairing

Pairing registers a scanner to the cradle such that the scanner and cradle can exchange information. The STB3678 and FLB3678 operate in two modes: Point-to-Point and Multipoint-to-Point. In Point-to-Point mode, pair the digital scanner to the cradle either by inserting it in the cradle (if pair on contacts is enabled), or by scanning the pairing barcode. In Multipoint-to-Point mode, you can pair up to seven scanners to one cradle. To use this feature, scan the multipoint barcode in [Multipoint-to-Point Communication on page 5-35](#).

To pair the digital scanner with the cradle, scan a pairing barcode. A high-low-high-low beep sequence followed by a low-high beep sequence indicates successful pairing and connection to the remote device. A long low, long high beep sequence indicates unsuccessful pairing.

- ✓ **NOTE** The pairing barcode that connects the digital scanner to a cradle is unique to each cradle.
Do not scan data or parameters until pairing completes.

Lost Connection to Host

If scanned data does not transmit to the cradle's host, ensure that all cables are firmly inserted and the power supply is connected to an appropriate AC outlet, if applicable. If scanned data still does not transmit to the host, reestablish a connection with the host:

1. Disconnect the power supply from the cradle.
2. Disconnect the host interface cable from the cradle.
3. Wait three seconds.
4. Reconnect the host interface cable to the cradle.
5. Reconnect the power supply to the cradle, if the host requires.
6. Reestablish pairing with the cradle by scanning the pairing barcode.

Configuring the Scanner

Use the barcodes in this manual or the 123Scan² configuration program to configure the digital scanner. See [Chapter 6, User Preferences & Miscellaneous Options](#) and each host chapter for information about programming the digital scanner using barcode menus. See [Chapter 2, 123Scan and Software Tools](#) to configure the digital scanner using this configuration program. 123Scan² includes a help file.

Radio Communications

The digital scanner can communicate with remote devices via Bluetooth, or by pairing with a cradle. For radio communication parameters, detailed information about operational modes, Bluetooth and pairing, see [Chapter 5, Radio Communications](#).

Four Slot Spare Battery Charger

The SAC3600-4001CR four slot spare battery charger charges up to four single spare batteries. The charger can sit on a desktop or mounted on a wall. This document provides basic instructions for charger set up and use. For best performance, fully charge the device battery before using the device for the first time. To charge the device battery, insert the battery in the cradle. The battery begins charging when the LED indicator on the battery charger starts flashing amber. A complete charge of a fully discharged battery can take up to five hours. Charge within the recommended temperature of 32° to 104° F (0° C to 40° C) nominal, 41° to 95° F (5° to 35° C) ideal.

For detailed LED definitions, see [Four Slot Battery Charger Definitions on page 3-6](#).

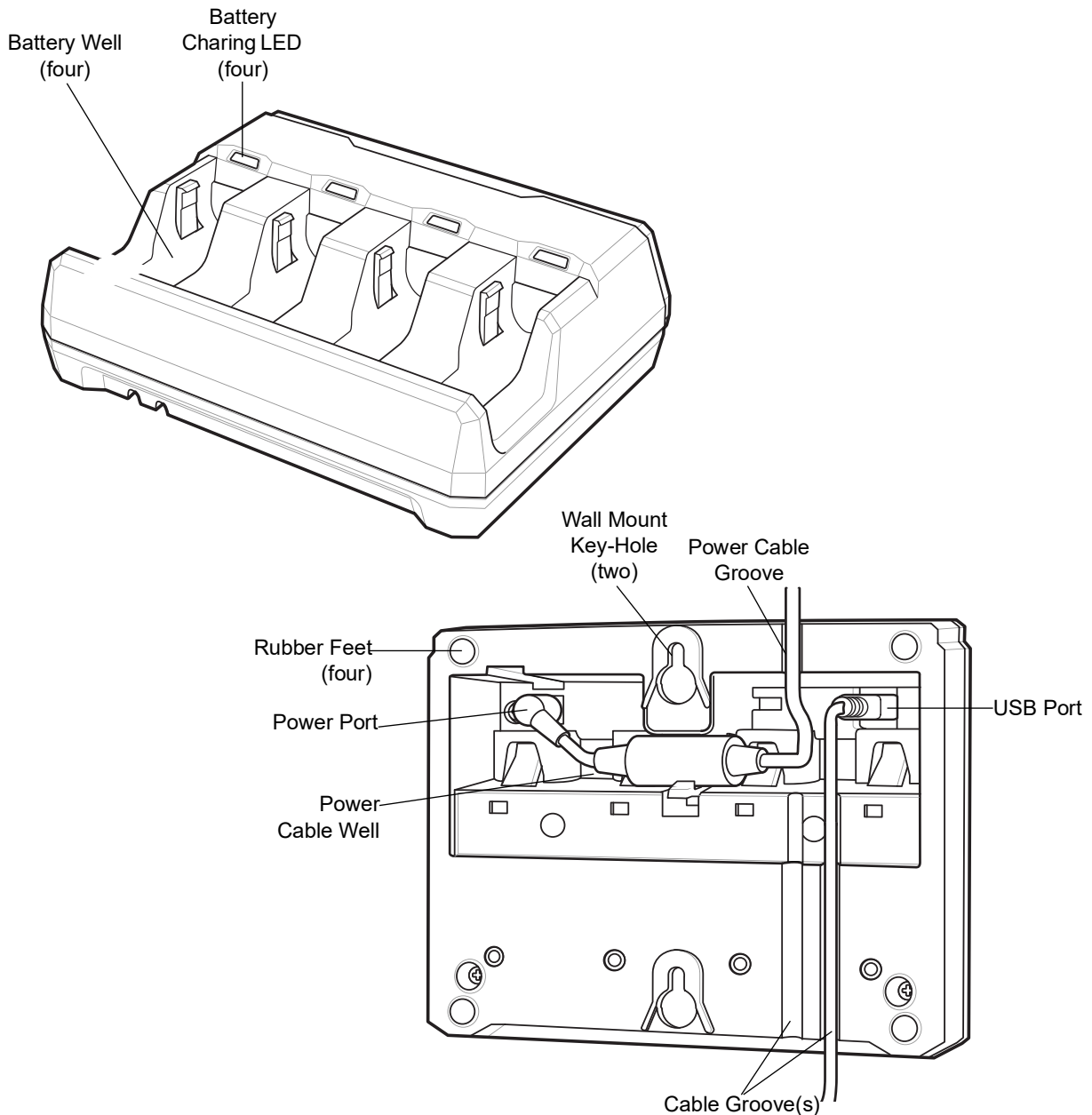

Figure 1-9 Four Slot Spare Battery Charger

Inserting Batteries

To insert batteries in the battery charger, angle the battery with the contacts facing up and slide the contact side of the battery under the LED indicator ledge as shown below. Push down on the label surface of the battery until it clicks in place, engaging the contacts in the battery charger.

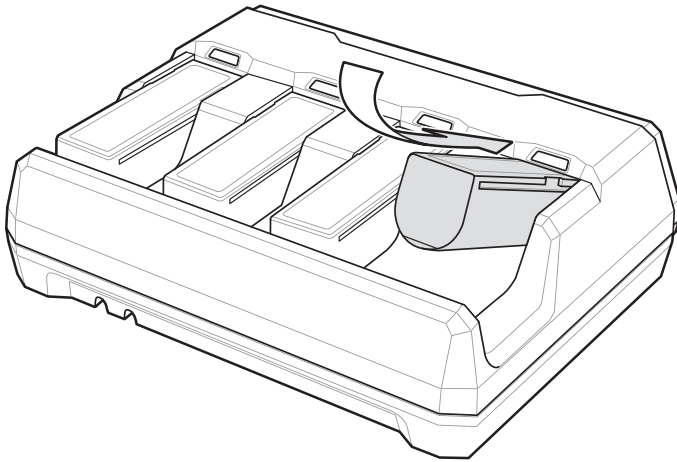

Figure 1-10 *Inserting Batteries*

Lanyard

✓ **NOTE** Do not attach the tool balancer to the lanyard slot at the bottom of the device.

To install the optional lanyard:

1. Insert the loop on the lanyard into the slot at the bottom of the device handle.

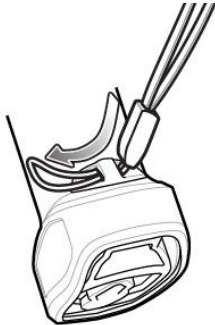

Figure 1-11 *Insert Lanyard Loop*

2. Thread the upper portion of the lanyard into the loop.



Figure 1-12 *Thread the Loop*

3. Pull the clip through the loop over the tether point and tighten into place.

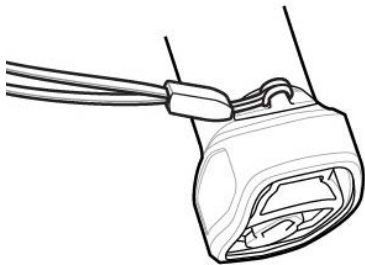

Figure 1-13 *Insert Loop into Tether Point*

DS3678 Accessories

The digital scanner ships with the *DS3678 Quick Start Guide*. The following required accessories must be ordered:

- Interface cable for the appropriate interface.
- Universal power supply, if the interface requires this.

See [Related Product Line Configurations on page xxviii](#). For additional items, contact a local Zebra representative or business partner.

DS3608 Corded Digital Scanner

DS3608 Parts

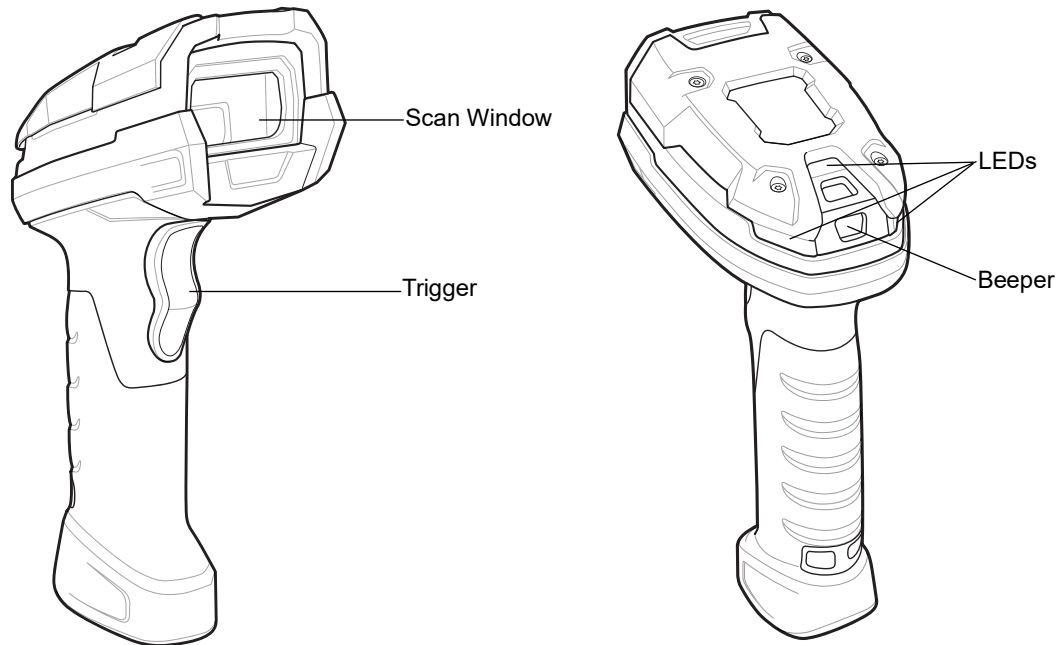

Figure 1-14 DS3608 Parts

Installing the DS3608 Interface Cable

1. Insert cable fully so that the connector is flush with the scanner surface.

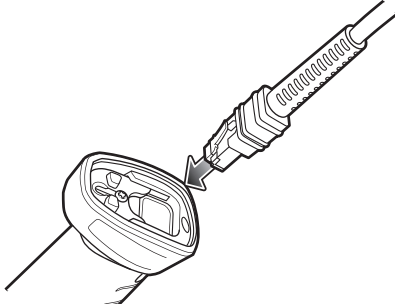

Figure 1-15 *Inserting Cable into DS3608*

2. Loosen metal lock plate screw using a PH1 driver.

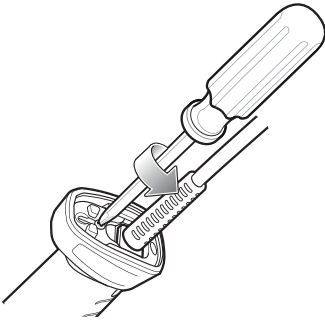

Figure 1-16 *Loosening DS3608 Lock Plate Screw*

3. Slide lock plate to fully locked position.

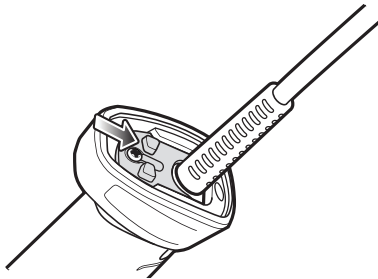

Figure 1-17 *Sliding Lock Plate into Locked Position*

4. Tighten lock plate screw using a PH1 driver (recommended Torque: 5 in-lbs).

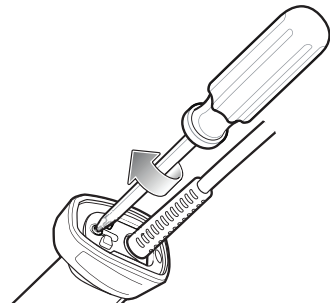

Figure 1-18 *Tightening Lock Plate*

Removing the DS3608 Interface Cable

1. Loosen lock plate screw using a PH1 driver.

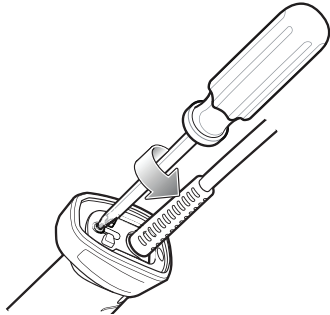

Figure 1-19 *Loosening Lock Plate*

2. Slide lock plate to fully unlocked position.

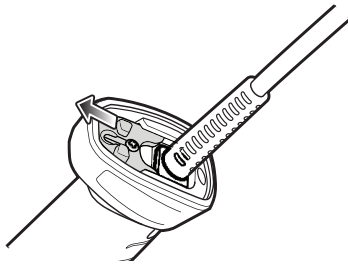

Figure 1-20 *Sliding Lock Plate into Unlocked Position*

3. Tighten lock plate to fully unlocked position.

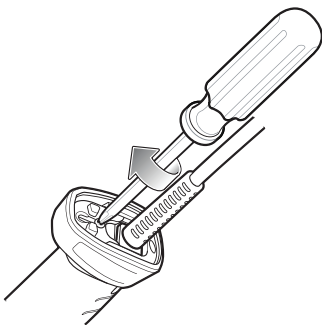

Figure 1-21 *Tightening Lock Plate into Unlocked Position*

4. Remove cable.

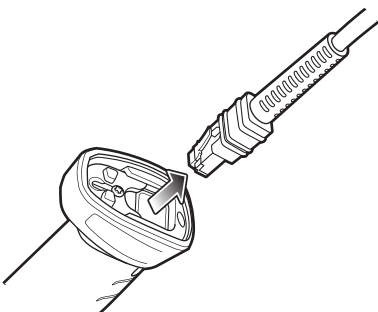

Figure 1-22 *Removing Cable from DS3608*

Connecting Power to the DS3608 (if required)

If the host does not provide power to the digital scanner, connect an external power supply.

1. Plug the power supply into the power jack on the interface cable.
2. Plug the other end of the power supply into an AC outlet.

Configuring the DS3608 Digital Scanner

To configure the digital scanner use the barcodes included in this manual, or use the 123Scan² configuration program. See [Chapter 6, User Preferences & Miscellaneous Options](#), and [Chapter 13, Symbologies](#) for information about programming the digital scanner using barcode menus. See [Chapter 2, 123Scan and Software Tools](#) for information on using this configuration program. Also see each host-specific chapter to set up connection to a specific host type.

DS3608 Accessories

The digital scanner ships with the *DS3608 Quick Start Guide*. The following required accessories must be ordered:

- Interface cable for the appropriate interface.
- Universal power supply, if the interface requires this.
- Intellistand for Hands-free operation of the DS3608.

See [Related Product Line Configurations on page 3-xxviii](#). For additional items, contact a local Zebra representative or business partner.

CHAPTER 2 123SCAN AND SOFTWARE TOOLS

Introduction

This chapter briefly describes the Zebra software tools available for customizing scanner operation.

123Scan

- ✓ **NOTE** With the DS36X8-DP imagers, it is difficult to scan large parameter barcodes generated by 123scan. In this case, it is recommended to use electronic programming only.

123Scan is a software tool that simplifies scanner setup and more.

Intuitive enough for first time users, the 123Scan wizard guides users through a streamlined setup process. Settings are saved in a configuration file that can be printed as a single programming barcode for scanning, emailed to a smart phone for scanning from its screen, or downloaded to the scanner using a USB cable.

Through 123Scan a user can:

- Configure a scanner using a wizard
 - Program the following scanner settings:
 - Beeper tone / volume settings
 - Enable / disable symbologies
 - Communication settings
 - Modify data before transmission to a host using:
 - Advanced Data Formatting (ADF) - Scan one barcode per trigger pull
 - Multicode Data Formatting (MDF) - Scan many barcodes in one trigger pull
 - Preferred Symbol - Single out one barcode on label of many (select scanners).
- Load parameter settings to a scanner via:
 - Bar code scanning:
 - Scan a paper barcode
 - Scan a barcode from a PC screen
 - Scan a barcode from a smart phone screen

- Download over a USB cable:
 - Load settings to one scanner
 - Stage up to 10 scanners simultaneously
- Validate scanner setup:
 - View scanned data within the utility's Data View screen
 - Capture an image and save to a PC within the utility's Data View screen
 - Review settings using the Parameter Report
 - Clone settings from an already deployed scanner
- Upgrade scanner firmware:
 - Load settings to one scanner
 - Stage up to 10 scanners simultaneously with a power USB hub
- View statistics such as:
 - Asset tracking information
 - Time and usage information
 - Bar codes scanned by symbology
 - Battery diagnostics
 - Communication diagnostics
- Generate the following reports:
 - Barcode Report - Programming barcode, included parameter settings, and supported scanner models
 - Parameter Report - Lists parameters programmed within a configuration file
 - Activity Report - Lists activities performed on a scanner(s)
 - Inventory Report - Lists scanner asset tracking information
 - Validation Report - Printout of scanned data
 - Statistics Report - Lists all statistics retrieved from the scanner

For more information go to: <http://zebra.com/123Scan>.

Communication with 123Scan

Use a USB cable to connect the scanner to a Windows host computer running 123Scan.

123Scan Requirements

- Host computer running Windows
- Scanner
- USB cable

123Scan Information

For more information on 123Scan, go to: <http://zebra.com/123Scan>

For a 1 minute tour of 123Scan, go to: <http://zebra.com/ScannerHowToVideos>

To see a list of all of our free software tools, go to: <http://zebra.com/scannersoftware>

Scanner SDK, Other Software Tools, and Videos

Tackle all your scanner programming needs with our diversified set of software tools. Whether you need to simply stage a device, or develop a fully featured application with image and data capture as well as asset management, these tools help you every step of the way.

To download any of the following free tools, go to: <http://zebra.com/scannersoftware>.

- 123Scan configuration utility
- SDKs
 - Scanner SDK for Windows
 - Scanner SDK for Android
 - Scanner SDK for Linux
- Drivers
 - OPOS driver
 - JPOS driver
 - TWAIN driver
 - USB CDC driver
 - Virtual COM port driver
- Scanner Management Service (SMS) for Remote Management
 - Windows
 - Linux
- Mobile Apps
 - Scan-To-Connect Utility
 - Android
 - Windows
- How-To-Videos

✓ **NOTE** For a list of SDK supported scanner functionality by communication protocol, see [Appendix J, Communication Protocol Functionality](#).

CHAPTER 3 DATA CAPTURE

Introduction

This chapter provides beeper and LED definitions, techniques involved in scanning barcodes, general instructions and tips about scanning, and decode ranges.

DS3678 Beeper and LED Definitions

The digital scanner issues different beep sequences/patterns and an LED display to indicate status. [Table 3-1](#) defines beep sequences/patterns and LED displays which occur during both normal scanning and while programming the digital scanner.

✓ **NOTE** Refer to the DS3678-HP PRG Supplement at zebra.com/support regarding DS3678-HP with Keypad & Display LED/Beeper definitions.

Radio and Beeper LED Definitions

In addition to the System/Decode LEDs, the DS3678 cordless digital scanner has a Radio and Battery LED gauge (see [DS3678 Parts on page 1-3](#)).

The Radio and Battery LED gauge is always active when inserted in the cradle. After the scanner is removed from the cradle, it is active for four seconds.

After the trigger is held for three seconds the Radio and Battery LED gauge remain active for four seconds after trigger release.

Table 3-1 DS3678 Scanner Beeper and LED Definitions

Event	Beeper Sequence	LED
Standard Use		
Power up.	Low/medium/high beeps	Green
Scanning		
Presentation Mode on.	None	Green solid
Presentation Mode off.	None	No LED; green LED is turned off
A barcode was successfully decoded. (See Chapter 6, User Preferences & Miscellaneous Options for programming beeper sounds.)	Medium beep (or as configured)	Green flash
Parity error.	Low/low/low/extra low beeps	Red
A transmission error was detected in a scanned symbol. The data is ignored. This occurs if a unit is not properly configured. Check option setting.	Four long low beeps	Red
Conversion or format error.	Five long low beeps	Red
A <BEL> character is received over RS-232.	High	None
Wireless Operation		
Out of batch storage memory, unable to store new barcode.	Low, high, low, high	Red
Radio Indications		
Scanner inserted into a cradle (may be disabled).	Low	System LED: None Radio LED: None
Bluetooth connection established.	Low, high	System LED: Green Radio LED: Green (Stays on after trigger hold for 3 seconds)
Bluetooth disconnection event.	High, low	System LED: Red Radio LED: Red (Stays on at trigger pull)
Bluetooth Page timeout; remote device is out of range/not powered.	Long low, long high	System LED: Red Radio LED: Red (Stays on at trigger pull)
Bluetooth connection attempt was rejected by remote device.	Long low, long high, long low, long high	System LED: None Radio LED: Red (Stays on at trigger pull)
Bluetooth attempting reconnection.	None	System LED: None Radio LED: Red blinking

Table 3-1 DS3678 Scanner Beeper and LED Definitions

Event	Beeper Sequence	LED
Bluetooth attempting reconnection (default is disable).	Five high	System LED: None Radio LED: Red blinking
Paging state indication	Six high	System LED: Blue (fast, fast, slow)
Battery Indications		
Low battery indication (on trigger release)	Four short high beeps	Red (stays on)
Battery LED status		99-51% Green 21-50% Amber 0-20% Red
Battery end of life		99-51% Green/red alternating 21-50% Amber/red alternating 0-20% Red blinking
Parameter Programming		
Input error, incorrect barcode or Cancel scanned, wrong entry, incorrect barcode programming sequence; remain in program mode.	Long low/long high beeps	Red
Keyboard parameter selected. Enter value using barcode keypad.	High/low beeps	Green
Successful program exit with change in the parameter setting.	High/low/high/low beeps	Green
ADF Programming		
ADF transmit error.	Low/high/low beeps	None
Number expected. Enter another digit. Add leading zeros to the front if necessary.	High/low beeps	Green
Alpha expected. Enter another alphabetic character or scan the End of Message barcode.	Low/low beeps	Green
ADF criteria or action is expected. Enter another criteria or action or scan the Save Rule barcode.	High/high beeps	Green blinking
All criteria or actions cleared for current rule, continue entering rule.	High/low/low beeps	Green
Rule saved. Rule entry mode exited.	High/low/high/low beeps	Green (turns off blinking)
Rule error. Entry error, wrong barcode scanned, or criteria/action list is too long for a rule. Re-enter criteria or action.	Long low/long high beeps	Red
Deleted last saved rule. The current rule is left intact.	Low beep	Green

Table 3-1 DS3678 Scanner Beeper and LED Definitions

Event	Beeper Sequence	LED
All rules deleted.	Low/high/high beeps	Green
Out of rule memory. Erase some existing rules, then try to save rule again.	Long low/long high/long low/long high beeps	Red
Cancel rule entry. Rule entry mode exited because of an error or the user asked to exit rule entry.	Long low/long high/long low beeps	Green (turns off blinking)
Host Specific		
USB only		
Digital scanner has not completed initialization. Wait several seconds and scan again.	Four high beeps	None
RS-232 only		
RS-232 receive error.	High/high/high/low beeps	Red
A <BEL> character is received when Beep on <BEL> is enabled (Point-to-Point mode only).	High beep	None

Cradle LED Definitions

Table 3-2 *Cradle LED Indications*

Event	LED
Standard Use	
Power Up	Green (stays on)
Radio Indications	
Bluetooth connection established	Green (off then on)
Page button	Blue
Battery Indications	
Pre-charging	Amber (stays on)
Charging	Amber blinking
Fully charged	Green (stays on)
Charging Error	Amber fast blinking
Battery End of Life Indications	
Charging	Red blinking
Fully charged	Red (stays on)
Charging error	Red fast blinking
Maintenance Indications	
Enter boot loader	Red (stays on)
Firmware installation	Red blinking

Four Slot Battery Charger Definitions

Table 3-3 *Four Slot Battery Charger LED Definitions*

Event	LED
Standard Use	
Power Up	Red, amber, green, off (all four LEDs)
Idle	Off
Battery Indications	
Pre-charging	Amber (stays on)
Charging	Amber blinking
Fully charged	Green (stays on)
Charging error	Amber fast blinking
Battery End of Life Indications	
Charging	Red blinking
Fully charged	Red (stays on)
Charging error	Red fast blinking
Maintenance Indications	
Enter bootloader	Red (stays on; all four LEDs)
Firmware installation	Red blinking (all four LEDs)

DS3608 Beeper and LED Definitions

In addition to beep sequences, the digital scanner uses a two-color LED to indicate status.

[Table 3-4](#) defines beep sequences that occur during both normal scanning and while programming the digital scanner; LED colors that display during scanning.

Table 3-4 *Beeper and LED Indicators*

Event	Beeper Sequence	LED Indicator
Standard Use		
Power up	Low, Medium, High beeps	Green
Decode a barcode	(as configured)	Green
Hands-free Mode (Presentation Mode On)	None	Green (stays on)
Hand-held Mode (Presentation Mode Off)	None	Green (stays off)
Transmission error	4 Low beeps	Red
Conversion or format error	5 Low beeps	Red
RS-232 receive error (Parity Error)	Low, Low, Low, Extra-Low beeps	Red
A <BEL> character is received over RS-232	High beep	None
Image Capture		
Snapshot mode started	Low beep	Green Blinking
Snapshot mode completed	Low beep	Default Green LED mode based upon Hand-held / Hands-free Mode state
Snapshot mode timed-out	High, Low beeps	Default Green mode based upon Hand-held / Hands-free Mode state
Video mode started	None	Green (stays on)
Video mode completed	None	Default Green mode based upon Hand-held / Hands-free Mode state
Parameter Programming		
Input error: Incorrect barcode, programming sequence, or Cancel scanned.	Low, High beeps	Red
Number expected. Enter value using numeric barcodes.	High, Low beeps	Green
Successful program exit with change in parameter setting.	High, Low, High, Low beeps	Green

Table 3-4 *Beeper and LED Indicators (Continued)*

Event	Beeper Sequence	LED Indicator
ADF Programming		
Enter another digit. Add leading zeros to the front if necessary.	High, Low beeps	Green
Enter another alphabetic character or scan the End of Message barcode.	Low, Low beeps	Green
ADF criteria or action is expected. Enter another criterion or action, or scan the Save Rule barcode.	High, High beeps	Green Blinking
Rule saved. Rule entry mode exited.	High, Low, High, Low beeps	Green (turns off blinking)
All criteria or actions cleared for current rule, continue entering rule.	High, Low, Low beeps	Green
Delete last saved rule. The current rule is left intact.	Low beep	Green
All rules are deleted.	Low, High, High beeps	Green
Out of rule memory. Erase some existing rules, then try to save rule again	Low, High, Low, High beeps	Red
Cancel rule entry. Rule entry mode exited because of an error or the user asked to exit rule entry.	Low, High, Low beeps	Green (turns off blinking)
Entry error, wrong barcode scanned, or criteria/action list is too long for a rule. Re-enter criterion or action.	Low, High beeps	Red
Macro PDF		
File ID error. A barcode not in the current MPDF sequence was scanned.	2 Low beeps	None
File ID error. A barcode not in the current MPDF sequence was scanned.	2 Long Low beeps	None
Out of memory. There is not enough buffer space to store the current MPDF symbol.	3 Long Low beeps	None
Bad symbology. Scanned a 1D or 2D barcode in a MPDF sequence, a duplicate MPDF label, a label in an incorrect order, or trying to transmit an empty or illegal MPDF field.	4 Long Low beeps	None
Flushing MPDF buffer	5 Long Low beeps	None
Aborting MPDF sequence	Fast Warble	None
Flushing an already empty MPDF buffer	Low, High beeps	None
Maintenance Indications		
Enter Bootloader	High, High beeps	Red (stays on)
Firmware Installation	None	Red Blinking

DS36X8 Scanning

1. Aim the digital scanner at a barcode and pull the trigger to decode.
2. Press the trigger until the digital scanner beeps, indicating the barcode is successfully decoded. For more information on beeper and LED definitions, see [DS3678 Beeper and LED Definitions on page 3-1](#).

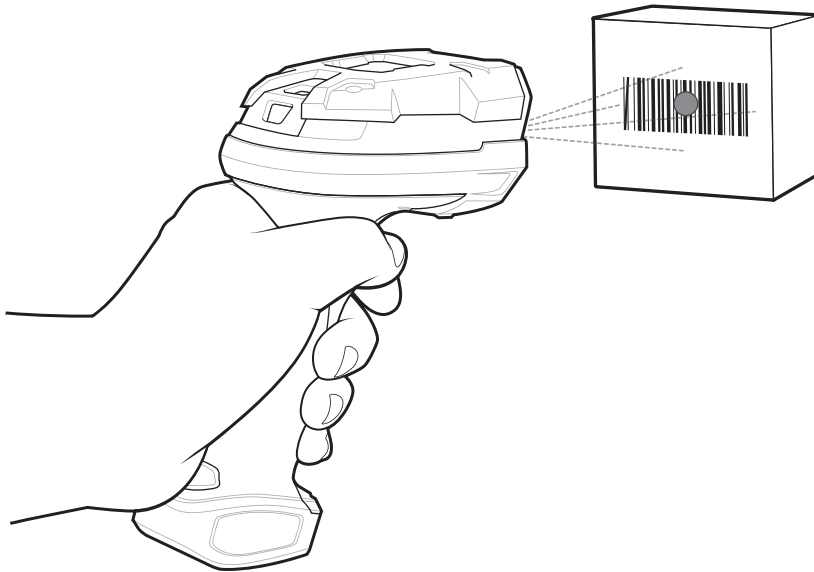

Figure 3-1 Scanning DS36X8-SR in Hand-held Mode

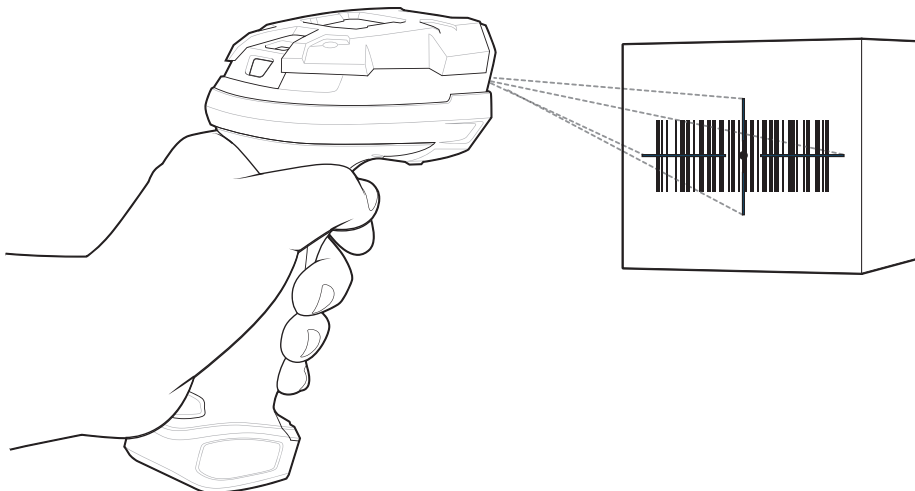

Figure 3-2 Scanning DS36X8-HD, DS36X8-HP, and DS36X8-XR in Hand-held Mode

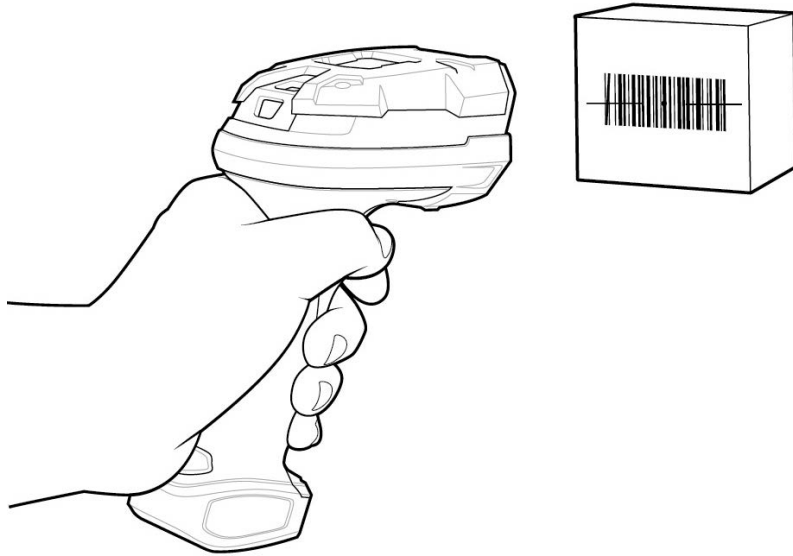

Figure 3-3 Scanning DS36X8-ER in Hand-held Mode

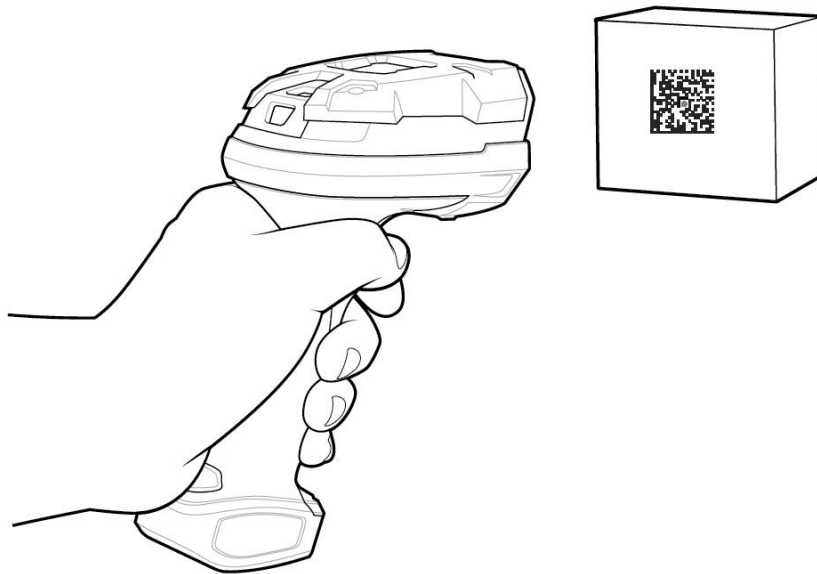

Figure 3-4 Scanning DS36X8-DP and DS36X8-DPA in Hand-held Mode

DS3608 Hands-free Mode

The DS3608 digital scanner is in Hands-free (presentation) mode when it is placed in the Intellistand. In this mode, the digital scanner operates in continuous (constant-on) mode, where it automatically decodes a barcode presented in its field of view.

Scanning in Hands-free (Presentation) Mode

The optional stand adds greater flexibility to DS3608 scanning operation. When the scanner is seated in the scanner cup, the scanner's built-in sensor places the scanner in Hands-free (presentation) mode. When the scanner is removed from the stand, it automatically switches to its programmed hand-held triggered mode.

To operate the digital scanner in the Intellistand:

1. Connect the digital scanner to the host (see the appropriate host chapter for information on host connections).

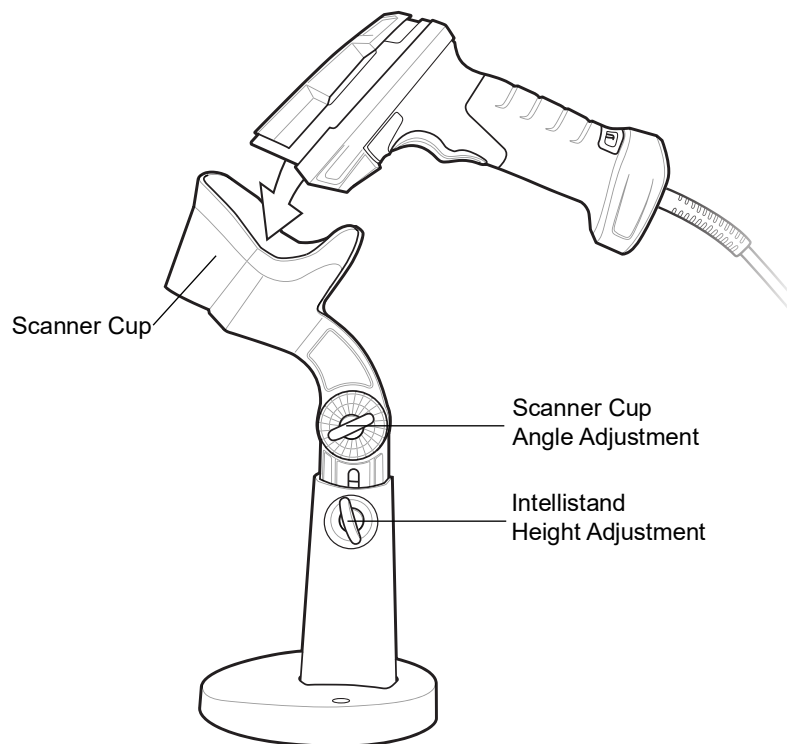

Figure 3-5 Scanning DS3608 in Hands-free Mode

2. Insert the digital scanner in the Intellistand by placing the front of the digital scanner into the scanner cup (see [Figure 3-5](#)).
3. Use the Intellistand's adjustment knobs to adjust the height and angle of the digital scanner.
4. Center the symbol in the aiming pattern.
5. Upon successful decode, the digital scanner beeps and the LED turns green. For more information on beeper and LED definitions, see [Table 3-4 on page 3-7](#).

DS36X8 Aiming

Aiming with DS36X8-SR

When scanning, the DS36X8-SR digital scanner projects an orange LED dot which allows positioning the barcode within its field of view. See [DS36X8-SR Aiming Pattern on page 3-12](#) for the proper distance to achieve between the digital scanner and a barcode.

If necessary, the digital scanner turns on its red LEDs to illuminate the target barcode.

To scan a barcode, center the symbol and ensure the entire symbol is within the rectangular area formed by the illumination LEDs. The digital scanner can also read a barcode presented within the aiming dot not centered.



Figure 3-6 DS36X8-SR Aiming Pattern

The aiming dot is smaller when the digital scanner is closer to the symbol and larger when it is farther from the symbol. Scan symbols with smaller bars or elements (mil size) closer to the digital scanner, and those with larger bars or elements (mil size) farther from the digital scanner.

The digital scanner beeps to indicate that it successfully decoded the barcode. For more information on beeper and LED definitions, see [Table 3-1 on page 3-2](#).

Aiming with DS36X8-HD and DS36X8-HP

When scanning, the DS36X8-HD and DS36X8-HP projects a red laser aiming pattern which allows positioning the barcode within its field of view. See [Table 3-6 on page 3-14](#) and [Table 3-7 on page 3-14](#) for the proper distance to achieve between the digital scanner and a barcode.

If necessary, the digital scanner turns on its white LEDs to illuminate the target barcode.

To scan a barcode, center the symbol in any orientation within the aiming pattern. Be sure the entire symbol is within the rectangular area formed by the cross pattern.



Figure 3-7 DS36X8-HD and DS36X8-HP Aiming Pattern

Aiming with DS36X8-XR

When scanning, the DS36X8-XR projects a green laser aiming pattern which allows positioning the barcode within its field of view. See [Table 3-12 on page 3-16](#) for the proper distance to achieve between the digital scanner and a barcode.

To scan a barcode, center the symbol in any orientation within the aiming pattern. Be sure the entire symbol is within the rectangular area formed by the cross pattern.



Figure 3-8 *DS36X8-XR Aiming Pattern*

Aiming with DS36X8-ER

When scanning, the DS36X8-ER projects a red laser aiming pattern which allows positioning the barcode within its field of view. See [Table 3-9 on page 3-15](#) for the proper distance to achieve between the digital scanner and a barcode.

If necessary, the digital scanner turns on its red LEDs to illuminate the target barcode.

To scan a barcode, center the symbol in any orientation within the aiming pattern. Be sure the entire symbol is within the area formed by the illumination LEDs.

The digital scanner can also read a barcode presented within the aiming pattern but not centered.

The two outer red lines are range indicators which help with near field barcode reading (distances under 2 feet). To ensure a successful decode, make sure the two outer red lines extend beyond the barcode width.

For distances beyond 2 feet, ensure that the dot is within the barcode.

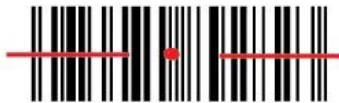

Figure 3-9 *DS36X8-ER Aiming Pattern*

Aiming with DS36X8-DP

When scanning, the DS36X8-DP and DS36X8-DPA projects a red laser aiming dot which allows positioning the barcode within its field of view. See [Table 3-10 on page 3-15](#) for the proper distance to achieve between the digital scanner and a barcode.



Figure 3-10 *DS36X8-DP and DS36X8-DPA Aiming Pattern*

The digital scanner beeps to indicate that it successfully decoded the barcode. For more information on beeper and LED definitions, see [Table 3-1 on page 3-2](#).

DS36X8 Decode Ranges

Table 3-5 DS36X8-DPA Decode Range

Table 3-6 DS36X8-HD Decode Ranges

Barcode Type	Symbol Density	DS36X8-HD Typical Working Ranges	
		Near	Far
Code 128	5.0 mil	0.9 in. / 2.3 cm	7.0 in / 17.8 cm
	15.0 mil	0.9 in. / 2.3 cm	23 in. / 58.4 cm
Code 39	3.0 mil	1.3 in / 3.3 cm	4.7 in / 11.9 cm
	20.0 mil	0.25 in / 0.6 cm	34.0 in / 86.3 cm
100% UPC	13.0 mil	0.25 in / 0.6 cm	22.0 in / 55.8 cm
PDF417	5.0 mil	2.0 in. / 5.1 cm	6.0 in. / 15.2 cm
	6.6 mil	0.9 in. / 2.3 cm	9.0 in. / 22.8 cm
Data Matrix	10.0 mil	1.0 in. / 2.5 cm	9.0 in. / 22.8 cm

Table 3-7 DS36X8-HP Decode Ranges

Barcode Type	Symbol Density	DS36X8-HP Typical Working Ranges	
		Near	Far
Code 128	5.0 mil	6.0 in / 15.2 cm	14.0 in / 35.5 cm
Code 39	20.0 mil	2.0 in / 5.1 cm	43.0 in / 109 cm
100% UPC	13.0 mil	1.1 in / 2.8 cm	36.0 in / 91.0 cm
PDF417	5.0 mil	8.0 in / 20.3 cm	11.5 in / 29.2 cm
Data Matrix	7.5 mil	7.0 in / 17.8 cm	11.0 in / 27.9 cm
	10.0 mil	6.0 in / 15.2 cm	15.0 in / 38.1 cm

Table 3-8 DS36X8-SR Decode Ranges

Barcode Type	Symbol Density	DS36X8-SR Typical Working Ranges	
		Near	Far
Code 128	5.0 mil	1.3 in / 3.3 cm	6.7 in / 17.0 cm
Code 39	5.0 mil	0.5 in / 1.2 cm	12.0 in / 30.4 cm
	20.0 mil	2.8 in / 7.1 cm	28.0 in / 71.0 cm
100% UPC	13.0 mil	0.3 in / 0.8 cm	24.0 in / 61.0 cm
PDF417	5.0 mil	1.9 in / 4.8 cm	6.9 in / 17.5 cm

Table 3-8 DS36X8-SR Decode Ranges

Barcode Type	Symbol Density	DS36X8-SR Typical Working Ranges	
		Near	Far
Data Matrix	7.5 mil	1.9 in / 4.8 cm	6.0 in / 15.2 cm
	10.0 mil	1.4 in / 3.6 cm	8.6 in / 21.8 cm

Table 3-9 DS36X8-ER Decode Ranges

Barcode Type	Symbol Density	DS36X8-ER Typical Working Ranges (20-30 fc ambient)	
		Near	Far
Code 128	15.0 mil	5.0 in / 12.7 cm	100.0 in / 254.0 cm
	40.0 mil	3.5 in / 8.8 cm	260.0 in / 660.4 cm
	100.0 mil Reflective	20.0 in / 50.8 cm	840.0 in / 2,133.6 cm
Code 39	100.0 mil	20.0 in / 50.8 cm	* 700.0 in / 1,778.0 cm
Data Matrix	10.0 mil	4.0 in / 10.1 cm	44.0 in / 111.76 cm
	55.0 mil	4.0 in / 10.1 cm	250.0 in / 635.0 cm
	100.0 mil	5.0 in / 12.7 cm	400.0 in / 1,016.0 cm
	200.0 mil	10.0 in / 25.4 cm	500.0 in / 1,270.0 cm

* Range is reduced under lower ambient light level.

Table 3-10 DS36X8-DP Decode Range

Barcode Type	Symbol Density	DS36X8-DP Typical Working Ranges	
		Near	Far
Code 39	3.0 mil	0.2 in / 0.5 cm	2.8 in / 7.1 cm
PDF417	5.0 mil	0.2 in / 0.5 cm	2.8 in / 7.1 cm
	6.6 mil	* 0.2 in / 0.5 cm	3.2 in / 8.1 cm
Data Matrix	5.0 mil	0.4 in / 1.0 cm	2.5 in / 6.3 cm
	10.0 mil	0.0 in / 0.0 cm	3.4 in / 8.6 cm
QR	5.0 mil	0.4 in / 1.0 cm	2.5 in / 6.3 cm
	10.0 mil	0.0 in / 0.0 cm	3.4 in / 8.6 cm
100% UPC	13.0 mil	* 1.0 in / 2.5 cm	5.8 in / 14.7 cm

* Field of view/barcode width limited. Decode ranges measured with DPM Mode Off (*DPM Mode on page 6-56*), photographic paper barcodes and under 30fcd ambient light conditions.

Table 3-11 DS36X8-DPA Decode Range

Barcode Type	Symbol Density	DS36X8-DPA Typical Working Ranges	
		Near	Far
Code 39	3.0 mil	0.5 in / 1.2 cm	4.7 in / 11.9 cm
	5.0 mil	0.0 in / 0.0 cm	5.6 in / 14.22 cm
Code 128	15.0 mil	* 3.3 in / 8.3 cm	11.0 in / 27.9 cm
PDF417	5.0 mil	0.4 in / 1.0 cm	3.0 in / 7.6 cm
	6.7 mil	0.1 in / 0.2 cm	4.0 in / 10.1 cm
Data Matrix	10.0 mil	0.2 in / 0.5 cm	4.8 in / 12.1 cm
QR	10.0 mil	0.2 in / 0.5 cm	4.8 in / 12.1 cm
100% UPC	13.0 mil	* 0.4 in / 1.0 cm	10.5 in / 26.6 cm

*** Field of view/barcode width limited. Decode ranges measured with DPM Mode Off ([DPM Mode on page 6-56](#)), photographic paper barcodes and under 30fcd ambient light conditions.**

Table 3-12 DS36X8-XR Decode Range

Barcode Type	Symbol Density	DS36X8-XR Typical Working Ranges	
		Near	Far
Code 39	5.0 mil	1.3 in / 3.3 cm	145 in / 368.3 cm
	7.5 mil	1.3 in / 3.3 cm	163 in / 414 cm
	20 mil	2 in / 5.1 cm	*217 in / 551.2 cm
	40 mil	** 6 in / 15.2 cm	*493 in / 1252.22cm
	55 mil Reflective	** 9 in / 22.9 cm	*733 in / 1861.8 cm
	100 mil	** 20 in / 50.8 cm	*1284 in / 3261.4 cm
Code 128	15.0 mil	* 3.3 in / 8.3 cm	11.0 in / 27.9 cm
Data Matrix	10.0 mil	1.3 in / 3.3 cm	66 in / 167.6 cm
QR	10.0 mil	1.3 in / 3.3 cm	55 in / 139.7 cm
100% UPC	13.0 mil	1.3 in / 3.3 cm	145 in / 368.3 cm

*** Range is reduced under lower ambient light**

**** Field of view/barcode width limited**

CHAPTER 4 MAINTENANCE & TECHNICAL SPECIFICATIONS

Introduction

This chapter provides suggested digital scanner maintenance, troubleshooting, technical specifications, and signal descriptions (pinouts).

Maintenance

Known Harmful Ingredients

The following chemicals are known to damage the plastics on Zebra scanners and should not come in contact with the device:

- Acetone
- Ammonia solutions
- Aqueous or alcoholic alkaline solutions
- Aromatic and chlorinated hydrocarbons
- Benzene
- Bleach
- Carboric acid
- Compounds of amines or ammonia
- Ethanolamine
- Ethers
- Ketones
- TB-lysoform
- Toluene
- Trichloroethylene.

Approved Cleaning Agents

The following cleaning agents are approved for cleaning the plastics on Zebra scanners:

- Pre-moistened wipes
- Isopropyl alcohol 70%

Tolerable Industrial Fluids and Chemicals

✓ **NOTE** Not all fluid variants and brands have been tested.

The following industrial fluids and chemicals were evaluated and deemed tolerable for the DS36X8:

- Motor/Engine Oil
- Automatic Transmission Fluid (ATF)
- Continuously Variable Transmission Fluid (CVT)
- Industrial De-Greaser (Engine Brite Heavy Duty)
- Brake Fluid (DOT4)

✓ **NOTE** It is recommended to clean the outside of the scanner daily using the [Approved Cleaning Agents on page 4-1](#) if the scanner comes in contact with the above fluids & chemicals frequently.

Cleaning the Digital Scanner

Routinely cleaning the exit window is required. A dirty window may affect scanning accuracy. Do not allow any abrasive material to touch the window.

To clean the scanner:

1. Dampen a soft cloth with one of the approved cleaning agents listed above or use pre-moistened wipes.
2. Gently wipe all surfaces, including the front, back, sides, top and bottom. Never apply liquid directly to the scanner. Be careful not to let liquid pool around the scanner window, trigger, cable connector or any other area on the device.
3. Be sure to clean the trigger and in between the trigger and the housing (use a cotton-tipped applicator to reach tight or inaccessible areas).
4. Do not spray water or other cleaning liquids directly into the exit window.
5. Wipe the scanner exit window with a lens tissue or other material suitable for cleaning optical material such as eyeglasses.
6. Immediately dry the scanner window after cleaning with a soft non-abrasive cloth to prevent streaking.
7. Allow the unit to air dry before use.
8. Scanner connectors:
 - a. Dip the cotton portion of a cotton-tipped applicator in isopropyl alcohol.
 - b. Rub the cotton portion of the cotton-tipped applicator back-and-forth across the connector on the Zebra scanner at least 3 times. Do not leave any cotton residue on the connector.
 - c. Use the cotton-tipped applicator dipped in alcohol to remove any grease and dirt near the connector area.
 - d. Use a dry cotton tipped applicator and rub the cotton portion of the cotton-tipped applicator back-and-forth across the connectors at least 3 times. Do not leave any cotton residue on the connectors.

Troubleshooting

Table 4-1 *Troubleshooting*

Problem	Possible Causes	Possible Solutions
The aiming pattern does not appear when pressing the trigger.	No power to the digital scanner.	If the configuration requires a power supply, re-connect the power supply.
	Incorrect host interface cable is used.	Connect the correct host interface cable.
	Interface/power cables are loose.	Re-connect cables.
	Digital scanner is disabled.	For IBM 468x and USB IBM Hand-held, IBM Table-top, and OPOS modes, enable the digital scanner via the host interface.
	If using RS-232 Nixdorf B mode, CTS is not asserted.	Assert CTS line.
	Aiming pattern is disabled.	Enable the aiming pattern. See Hand-held Decode Aiming Pattern on page 6-24 .
Digital scanner emits aiming pattern, but does not decode the barcode.	Digital scanner is not programmed for the correct barcode type.	Program the digital scanner to read that type of barcode. See Chapter 13, Symbologies .
	Barcode symbol is unreadable.	Scan test symbols of the same barcode type to determine if the barcode is defaced.
	The symbol is not completely inside aiming pattern.	Move the symbol completely within the aiming pattern. Move the symbol completely within the field of view (AIM pattern does NOT define FOV)
	Distance between digital scanner and barcode is incorrect.	Move the scanner closer to or further from the barcode. See DS36X8 Decode Ranges on page 3-14 .

Table 4-1 *Troubleshooting (Continued)*

Problem	Possible Causes	Possible Solutions
Digital scanner decodes barcode, but does not transmit the data to the host.	Digital scanner is not programmed for the correct host type.	Scan the appropriate host type programming barcode. See the chapter corresponding to the host type.
	Interface cable is loose.	Re-connect the cable.
	Cradle is not programmed for the correct host type.	Check digital scanner host parameters or edit options.
	Digital scanner is not paired to host connected interface.	Pair digital scanner to the cradle by scanning the PAIR barcode on the cradle.
	Cradle has lost connection to the host.	In this exact order: disconnect power supply; disconnect host cable; wait three seconds; reconnect host cable; reconnect power supply; reestablish pairing.
	If the digital scanner emits 4 long low beeps, a transmission error occurred. This occurs if a unit is not properly configured or connected to the wrong host type.	Set the scanner's communication parameters to match the host's setting.
	If the digital scanner emits 5 low beeps, a conversion or format error occurred.	Configure the digital scanner's conversion parameters properly.
Host displays scanned data incorrectly.	Digital scanner is not programmed to work with the host.	Scan the appropriate host type programming barcode.
		For RS-232, set the digital scanner's communication parameters to match the host's settings.
		For a Keyboard Wedge configuration, program the system for the correct keyboard type, and turn off the CAPS LOCK key.
		Program the proper editing options (e.g., UPC-E to UPC-A Conversion).
Digital scanner emits short low/short medium/short high beep sequence (power-up beep sequence) more than once.	The USB bus may put the digital scanner in a state where power to the scanner is cycled on and off more than once.	Normal during host reset.

Table 4-1 Troubleshooting (Continued)

Problem	Possible Causes	Possible Solutions
Digital scanner emits 4 short high beeps during decode attempt.	Digital scanner has not completed USB initialization.	Wait several seconds and scan again.
Digital scanner emits Low/low/low/extra low beeps when not in use.	RS-232 receive error.	Normal during host reset. Otherwise, set the digital scanner's RS-232 parity to match the host setting.
Digital scanner emits low/high beeps during programming.	Input error, incorrect barcode or Cancel barcode was scanned.	Scan the correct numeric barcodes within range for the parameter programmed.
Digital scanner emits low/high/low/high beeps during programming.	Out of host parameter storage space.	Scan User Preferences Parameter Defaults on page 6-2 .
	Out of memory for ADF rules.	Reduce the number of ADF rules or the number of steps in the ADF rules.
	During programming, indicates out of ADF parameter storage space.	Erase all rules and re-program with shorter rules.
Digital scanner emits low/high/low beeps.	ADF transmit error.	Refer to the Advanced Data Formatting Guide for information.
	Invalid ADF rule is detected.	Refer to the Advanced Data Formatting Guide for information.
Digital scanner LED blinks even if the pairing request was canceled from remote iOS/Android device.	If pass key entry is canceled from the tablet/phone, the digital scanner remains in the pass key entry mode for 30 seconds before timing out.	To exit pass key entry mode scan Cancel on page H-2 or scan any other barcode.
Digital scanner emits a power-up beep after changing USB host type.	The USB bus re-established power to the digital scanner.	Normal when changing USB host type.
Digital scanner emits one high beep when not in use.	In RS-232 mode, a <BEL> character was received and Beep on <BEL> option is enabled.	Normal when Beep on <BEL> is enabled and the digital scanner is in RS-232 mode.
Digital scanner emits frequent beeps.	No power to the scanner.	Check the system power. If the configuration requires a power supply, re-connect the power supply.
	Incorrect host interface cable is used.	Verify that the correct host interface cable is used. If not, connect the correct host interface cable.
	Interface/power cables are loose.	Check for loose cable connections and re-connect cables.

Table 4-1 *Troubleshooting (Continued)*

Problem	Possible Causes	Possible Solutions
Digital scanner emits five long low beeps after a barcode is decoded.	Conversion or format error was detected. The scanner's conversion parameters are not properly configured.	Ensure the scanner's conversion parameters are properly configured.
	Conversion or format error was detected. An ADF rule was set up with characters that can't be sent for the host selected.	Change the ADF rule, or change to a host that can support the ADF rule.
	Conversion or format error was detected. A barcode was scanned with characters that can't be sent for that host.	Change the barcode, or change to a host that can support the barcode.



NOTE If after performing these checks the digital scanner still experiences problems, contact the distributor or call support.

Report Software Version Bar Code

When contacting support, a support representative may ask you to scan the barcode below to determine the version of software installed in the digital scanner.

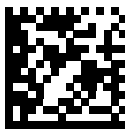

Report Software Version

Technical Specifications

DS36X8 Technical Specifications

Table 4-2 Technical Specifications - DS3678 and DS3608 Digital Scanners

Item	Description
Physical Characteristics	
Dimensions	
DS3678	7.3 in. H x 3.0 in. W x 5.6 in. D (18.5 cm H x 7.7 cm W x 14.3 cm D)
DS3608	7.3 in. H x 3.0 in. W x 5.2 in. D (18.5 cm H x 7.7 cm W x 13.2 cm D)
DS3678 Weight (with Battery)	
DS3678-HD	Approximately 14.50 oz./411 g
DS3678-HP	Approximately 14.50 oz./411 g
DS3678-SR	Approximately 14.34 oz./407 g
DS3678-ER	Approximately 15.38 oz./436 g
DS3678-DP	Approximately 14.18 oz./402 g
DS3678-XR	Approximately 14.46 oz./410 g
DS3608 Weight (without Cable)	
DS3608-HD	Approximately 10.90 oz./309 g
DS3608-HP	Approximately 10.90 oz./309 g
DS3608-SR	Approximately 10.76 oz./305 g
DS3608-ER	Approximately 11.80 oz./334 g
DS3608-DP	Approximately 10.72 oz./304 g
DS3678-XR	Approximately 10.86 oz./308 g
Power	
DS3608-HD	5 VDC +/- 10% @ 360 mA (RMS typical)
DS3608-HP	5 VDC +/- 10% @ 360 mA (RMS typical)
DS3608-SR	5 VDC +/- 10% @ 360 mA (RMS typical)
DS3608-ER	5 VDC +/- 10% @ 800 mA (RMS typical)
DS3608-DP	5 VDC +/- 10% @ 360 mA (RMS typical)
DS3608-XR	5 VDC +/- 10% @ 360 mA (RMS typical)
Color	Industrial Green
USB Certification	DS3608 is USB2.0 Full Speed Compliant, visit USB.org for more details (Only applies to corded model).
Performance Characteristics	

Table 4-2 Technical Specifications - DS3678 and DS3608 Digital Scanners (Continued)

Item	Description
Light Source	
DS36X8-SR	Aiming pattern: 610 nm LED / Illumination: 660 nm LEDs
DS36X8-HP	Aiming pattern: 655 nm Laser / Illumination: Warm white LEDs
DS36X8-HD	Aiming pattern: 655 nm Laser / Illumination: Warm white LEDs
DS36X8-ER	Aiming pattern: 655 nm Laser / Illumination: 660 nm LEDs
DS36X8-DP	Aiming pattern: 655 nm Laser / Illumination: Warm white and red 634nm LEDs
DS36X8-XR	Aiming pattern: 515 nm Laser / Illumination: Warm white LEDs
Field of View (Horizontal x Vertical) Nominal	
DS36X8-SR	42° (H) x 28° (V)
DS36X8-HP	31° (H) x 23° (V)
DS36X8-HD	48° (H) x 36.7° (V)
DS36X8-ER	Near: 32° (H) x 20° (V) / Far: 12° (H) x 7.6° (V)
DS36X8-DP	31° (H) x 23° (V)
DS36X8-XR	42° (H) x 27° (V), Far: 14° (H) x 7.9° (V)
Roll	0 - 360°
Pitch	+/- 60°
Skew	+/- 60°
Scans Per Charge	
DS36X8-HD	Up to 100,000
DS36X8-HP	Up to 100,000
DS36X8-SR	Up to 100,000
DS36X8-ER	Up to 70,000
DS36X8-DP	Up to 100,000
DS36X8-XR	Up to 80,000
Symbology Decode Capability	
1D	UPC/EAN, UPC/EAN with supplementals, Bookland EAN, ISSN, UCC Coupon Extended Code, Code 128, GS1-128, ISBT 128, ISBT Concatenation, Code 39, Code 39 Full ASCII, Trioptic Code 39, Code 32, Code 93, Code 11, Interleaved 2 of 5, Discrete 2 of 5, Codabar, MSI, Chinese 2 of 5, Matrix 2 of 5, Korean 3 of 5, GS1 DataBar variants
2D	PDF417, MicroPDF417, Composite Codes, TLC-39, Data Matrix, Maxicode, QR Code, MicroQR, Aztec, Han Xin, GS1-QR, GS1-DM
Postal	US Postnet, US Planet, UK Postal, Japan Post, Australia Post, Royal Mail 4 State Customer, KIX Code (Dutch), UPU 4 State Postal FICS (Post US4), USPS 4 State Postal (Post US3)
Typical Working Distance	See DS36X8 Decode Ranges on page 3-14 .

Table 4-2 *Technical Specifications - DS3678 and DS3608 Digital Scanners (Continued)*

Item	Description
Interfaces Supported	USB, RS-232, RS-485 (IBM 46xx), keyboard wedge, SSI The scanner supports the following protocols over USB: HID Keyboard (default mode), SNAPI, COM Port Emulation, IBM SurePOS (Yellowstone) (IBM Hand-held, IBM Table-top, OPOS), USB CDC, SSI over USB CDC The scanner supports the following protocols over RS232: Standard, Wincor-Nixdorf, ICL, Fujitsu, Olivetti, Omron, CUTE
Minimum Resolution DS36X8-HD DS36X8-HP DS36X8-SR DS36X8-ER DS36X8-DP DS36X8-XR	Code 39 3 mil UPC 40% 5.2 mil PDF417 5 mil Data Matrix 6 mil Code 39 3 mil UPC 40% 5.2 mil PDF417 5 mil Data Matrix 7.5 mil Code 39 4 mil UPC 60% 7.8 mil PDF417 5 mil Data Matrix 7.5 mil Code 39 3 mil PDF417 5 mil Data Matrix 10 mil Code 39 3 mil PDF417 4 mil Data Matrix 4 mil Code 39 3 mil PDF417 5 mil Data Matrix 10 mil
User Environment	
Operating Temperature DS3678 DS3608	- 4° F to 122°F (-20° C to 50° C) - 22° F to 122°F (-30° C to 50° C)
Storage Temperature	-40° F to 158° F (-40° C to 70° C)
Humidity	5% to 95% RH, non-condensing
ESD	25 kV air discharge (DS36X8-DP: 20 kV air discharge) 10 kV contact discharge

Table 4-2 *Technical Specifications - DS3678 and DS3608 Digital Scanners (Continued)*

Item	Description
Drop Specifications DS36X8 DS3678 DS3608	Withstands multiple 10 ft / 3.0m drops to concrete at room temperature. Withstands multiple 8 ft / 2.4 m drops to concrete at -20° C to 50° C Withstands multiple 8 ft / 2.4 m drops to concrete at -30° C to 50° C
Environmental Sealing	IP65 and IP68
Ambient Light Immunity	0 to 10,037 Foot Candles 0 to 108,000 Lux.
Accessories	
DS3608 Hands-free Option	Intellistand
Power Supplies	Power supplies are available for applications that do not supply power over the host cable.

Cradle Specifications

Table 4-3 *Technical Specifications - STB3678 and FLB3678 Cradles*

Item	Description
Power Requirements Host Powered: External Power Supply:	min 4.5 - max 5.5 min 11.4 - max 12.6
Typical Current Draw Not Charging: Full Charging Mode: Safe Charging Mode:	80mA @ 5V 30mA @ 12V 1200mA @ 5V (BC 1.2), 475mA (non-BC1.2) 700mA @ 12V 400mA @ 5V 200mA @ 12V
Interfaces Supported	Keyboard Wedge, RS-232, USB, IBM 468X/469X
Operating Temperature	-4° to 122° F (-20° to 50° C)
Storage Temperature	-40° to 158° F (-40° to 70° C)
Charging Temperature	32° to 104° F (0° to 40° C) nominal, 41° to 95° F (5° to 35° C) ideal
Humidity	5% to 95% (non-condensing)
ESD	25 kV air discharge 10 kV contact discharge

Table 4-3 *Technical Specifications - STB3678 and FLB3678 Cradles*

Item	Description
Weight STB3678 FLB3678 Mounting Plate	12 oz (340 grams) 13.7 oz (390 grams) 8.5 oz (240 grams)
Dimensions: STB3678 FLB3678	W 9.98 x L 22.94 x H 8.26 cm (W 99.8 x L 229.4 x H 82.6 mm) W 10.94 x L 27.69 x H 10.7 cm (W 109.4 x L 276.9 x H 107 mm) with Mounting Plate
Radio	Bluetooth, Up to 100 meters/300 ft. in open air range/environment Serial Port & HID Profiles 2.402 to 2.480 GHz Adaptive Frequency Hopping (co-existence with 802.11 wireless networks) 3Mbit/s (2.1Mbit/s) for Classic Bluetooth 1Mbit/s (0.27Mbit/s) for Low Energy
Electrical Safety	Certified Pending to UL1950, CSA C22.2 No.950. EN60950/IC950
Input Transient Protection	IEC 1000-4-(2,3,4,5,6,11)
EMI	FCC Part 15 Class B, ICES-003 Class B European Union EMC Directive, Australian SMA, Taiwan EMC, Japan VCCI/MITI/Dentori

DS3608 Digital Scanner Signal Descriptions

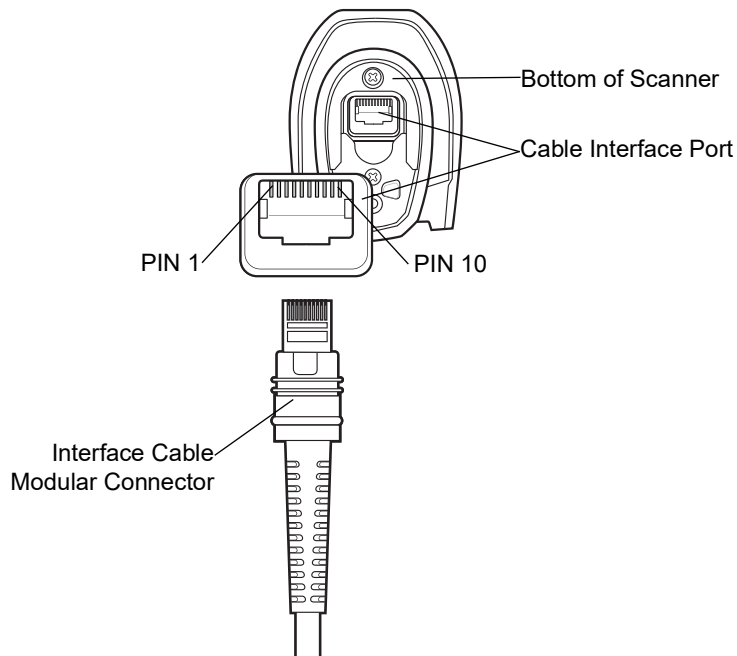

Figure 4-1 DS3608 Digital Scanner Cable Pin-outs

The signal descriptions in [Table 4-4](#) apply to the connectors on the DS3608 digital scanner and are for reference only.

Table 4-4 DS3608 Digital Scanner Signal Pin-outs

Pin	IBM	RS-232	Keyboard Wedge	USB
1	Cable ID	Cable ID	Cable ID	Cable ID
2	Power (+5V)	Power (+5V)	Power (+5V)	Power (+5V)
3	Ground	Ground	Ground	Ground
4	IBM_OUT	TxD	KeyClock	Reserved
5	IBM_IN	RxD	TermData	D +
6	IBM_T/R	RTS	KeyData	Reserved
7	Reserved	CTS	TermClock	D -
8	Reserved	Reserved	Reserved	Reserved
9	Reserved	Reserved	Reserved	Reserved
10	Power (+12V)	Power (+12V)	Power (+12V)	Power (+12V)

CHAPTER 5 RADIO COMMUNICATIONS

Introduction

This chapter provides information about the modes of operation and features available for wireless communication between the DS3678 cordless digital scanners, cradles and hosts. The chapter also includes the parameters necessary to configure the digital scanner.

The digital scanner ships with the settings shown in the [Radio Communication Default Table on page 5-2](#) (also see [Appendix A, Standard Default Parameters](#) for all host device and digital scanner defaults). If the default values suit requirements, programming is not necessary.

To set feature values, scan a single barcode or a short barcode sequence. The settings are stored in non-volatile memory and are preserved even when the digital scanner is powered down.

If not using a Synapse or USB cable with the cradle, select a host type (see each host chapter for specific host information) after the power-up beeps sound. This is only necessary upon the first power-up when connected to a new host.

To return all features to default values, scan a default barcode in [Default Parameters on page 6-5](#). Throughout the programming barcode menus, default values are indicated with asterisks (*).

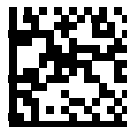

* Indicates Default — * **Enable Pair on Contacts** — Feature/Option
(0) — Option Value

Scanning Sequence Examples

In most cases, scan one barcode to set a specific parameter value.

Errors While Scanning

Unless otherwise specified, to correct an error during a scanning sequence, just re-scan the correct parameter.

Radio Communications Parameter Defaults

[Table 5-1](#) lists the defaults for radio communication parameters. If you wish to change any option, scan the appropriate barcode(s) provided in the Radio Communications Parameters section beginning on [page 5-5](#).

✓ **NOTE** See [Appendix A, Standard Default Parameters](#) for all user preferences, hosts, symbologies, and default parameters.

In this guide, the parameter numbers listed are the same as the attribute numbers for these parameters.

NOTE See [Appendix B, Country Codes](#) for Country Keyboard Types (Country Codes).

Table 5-1 Radio Communication Default Table

Parameter	Parameter Number ¹	SSI Number ²	Default	Page Number
Radio Communications Host Types	383	F0h 7Fh	Cradle Host	5-5
BT Friendly Name	607	F1h 5Fh	n/a	5-11
Discoverable Mode	610	F1h 62h	General	5-12
Wi-Fi Friendly Mode	1299	F8h 05h 13h	Disable	5-13
Wi-Fi Friendly Channel Exclusion	1297	F8h 05h 11h	Use All Channels	5-14
Radio Output Power	1324	F8h 05h 12Ch	High	5-17
Link Supervision Timeout	1698	F8h 06h A2h	5 Seconds	5-18
Bluetooth Radio State	1354	F8h 05h 4Ah	On	5-19
Apple iOS Virtual Keyboard Toggle	1114	F8h 04h 5Ah	Disable	5-20
HID Keyboard Keystroke Delay	N/A	N/A	No Delay (0 msec)	5-21
CAPS Lock Override	N/A	N/A	Disable	5-21
HID Ignore Unknown Characters	N/A	N/A	Send Bar Codes with Unknown Characters	5-22
Emulate Keypad	N/A	N/A	Enable	5-22
Fast HID Keyboard	1361	F8h 05h 51h	Enable	5-23
Quick Keypad Emulation	1362	F8h 05h 52h	Enable	5-23
Keyboard FN1 Substitution	N/A	N/A	Disable	5-24
Function Key Mapping	N/A	N/A	Disable	5-24
Simulated Caps Lock	N/A	N/A	Disable	5-25
Convert Case	N/A	N/A	No Case Conversion	5-25
Reconnect Attempt Beep Feedback	559	F1h 2Fh	Disable	5-27

**1. Parameter number decimal values are used for programming via RSM commands.
2. SSI number hex values are used for programming via SSI commands.**

Table 5-1 Radio Communication Default Table (Continued)

Parameter	Parameter Number ¹	SSI Number ²	Default	Page Number
Reconnect Attempt Interval	558	F1h 2Eh	30 Seconds	5-28
Auto-reconnect	604	F1h 5Ch	Auto-reconnect Immediately	5-30
Sleep Between Attempts	1778	F8h 06h F2h	Sleep for 1 Minute	5-31
Number of Retry Attempts	1779	F8h 06h F3h	Do Not Retry	5-32
Beep on Insertion	288	120h	Enable	5-34
Modes of Operation (Point-to-Point/Multipoint-to-Point)	538	F1h 1Ah	Point-to-Point	5-35
Parameter Broadcast (Cradle Host Only)	148	94h	Enable	5-36
Pairing Modes	542	F1h 1Eh	Unlocked	5-37
Pairing Methods	545	F1h 21h	Enable	5-38
Toggle Pairing	1322	F8h 05h 2Ah	Disable	5-39
Connection Maintenance Interval	5002	N/A	15 Minutes	5-40
AutoConfig (Scanner Cloning Through Cradle)	2139	F8 08 5B	Disable	5-43
Batch Mode	544	F1h 20h	Normal (Do Not Batch Data)	5-43
Persistent Batch Storage	1399	F8h 05h 77h	Disable	5-48
Page Button	746	F1h EAh	Enable	5-49
Page Options				
Page Mode	1364	F8h 05h 54h	Page Simple	5-50
Page State Timeout	1365	F8h 05h 55h		5-51
PIN Code (Set and Store)	552	F1h 28h	12345	5-52
Variable Pin Code	608	F1h 60h	Static (Default PIN code is 12345)	5-53
Bluetooth Security Levels	1393	F8h 05h 71h	Low	5-54
Save Bluetooth Connection Information	1743	F8h 06h CFh	Enable	5-56
Configuring the Alarm on the Scanner	2053	F8h 08h 05h	Disable	5-57
Audio Virtual Tether Alarm on Scanner	2246	F8h 08h C6h	Enable Audio Virtual Tether Alarm	5-58

**1. Parameter number decimal values are used for programming via RSM commands.
2. SSI number hex values are used for programming via SSI commands.**

Table 5-1 Radio Communication Default Table (Continued)

Parameter	Parameter Number ¹	SSI Number ²	Default	Page Number
LED Virtual Tether Alarm on Scanner	2247	F8h 08h C7h	Enable	5-58
Illumination Virtual Tether Alarm on Scanner	2248	F8h 08h C8h	Enable	5-59
Haptic Virtual Tether Alarm on Scanner	2249	F8h 08h C9h	Enable	5-59
Virtual Tether Alarm on the Cradle	2124	F8h 08h 4Ch	Disable	5-60
Delay Before Virtual Alarm Activates	2054	F8h 08h 06h	None	5-60
Virtual Tether Alarm Duration	2055	F8h 08h 07h	None	5-61
Defeat Virtual Tether Alarm	2119	F8h 08h 47h	Pause Alarm on Trigger Pull/Page Button	5-62
Pause Virtual Tether Alarm Duration	2120	F8h 08h 48h	None	5-63

- 1. Parameter number decimal values are used for programming via RSM commands.**
- 2. SSI number hex values are used for programming via SSI commands.**

Wireless Beeper Definitions

When the digital scanner scans the pairing barcode it issues various beep sequences indicating successful or unsuccessful operations. See [DS3678 Scanner Beeper and LED Definitions on page 3-2](#) for all beep sequences and LED displays including those which occur during pairing operations.

Radio Communications Host Types

Parameter # 383 (F0h 7Fh)

To set up the digital scanner for communication with a cradle, or to use standard Bluetooth profiles, scan the appropriate host type barcode below.

Classic Bluetooth vs. Low Energy Bluetooth

Bluetooth Low Energy (LE) Bluetooth has a better Wi-Fi coexistence, as advertising and connection is done outside of the Wi-Fi channels 1, 6, and 11 (2402, 2426, 2480 MHz). Due to its lower data rate, Bluetooth Low Energy is up to seven times slower than Classic Bluetooth (0.27 Mbps versus 0.7-2.1 Mbps). Data intensive activities such as firmware updates, can take significantly longer over Bluetooth Low Energy.

Cradle

Select this host type when connecting a scanner to a communication cradle.



NOTE The scanner automatically tries to reconnect to a remote device when a disconnection occurs that is due to the radio losing communication. See [Reconnect Attempt Beep Feedback on page 5-26](#) for more information.

To establish a connection (for initial setup only):

1. Scan the **Cradle-Classic Bluetooth** or **Cradle-Low Energy** barcode.
2. Scan the pairing barcode on the cradle or place the scanner in the cradle.



Cradle-Classic



Cradle-Low Energy

Keyboard Emulation (HID)

Select this host type when connecting to a PC/tablet/phone emulating a Bluetooth keyboard.

- **HID BT Classic** - Enables the host and scanner to communicate using HID (Human Interface Device) Keyboard Profile over Bluetooth Classic radio. The scanner(s) are discoverable (Peripheral mode) and also support Central mode.

To establish a connection (initial setup only):

- i. Scan the **HID BT Classic** barcode.
 - ii. Connect to central or peripheral mode.
 - Central mode - scan a pairing barcode with the MAC address of the host device.
 - Peripheral mode - from the host, discover Bluetooth devices and select your scanner from the discovered device list.
- **HID BT LE (Discoverable)** - Enables the host to establish a HID (Human Interface Device) Keyboard Profile connection with the scanner over Bluetooth Low Energy radio. The scanner is discoverable (Peripheral mode).

To establish a connection (initial setup only):

- i. Scan the **HID BT LE (Discoverable)** barcode.
- ii. From the host, discover Bluetooth devices.
- iii. Select your scanner from your discovered device list.

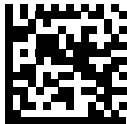

HID Bluetooth Classic



HID BT LE (Discoverable)

Simple Serial Interface (SSI)

Select this host type when connecting to a Zebra mobile device or PC/tablet/phone running a Zebra scanner SDK app.

- **SSI BT Classic (Non-discoverable)** - Enables communication with Zebra Mobile Computers. It enables the scanner(s) to establish a connection with the host over Classic Bluetooth radio. The scanner is NOT in discoverable (Central mode).

To establish a connection (initial setup only):

- i. Scan the **SSI BT Classic (Non-discoverable)** barcode.
- ii. Scan a pairing barcode with the host device's MAC address.

✓ **NOTE** Additional steps may be necessary depending on host's Bluetooth stack.

- **SSI BT Classic (Discoverable)** - Enables communication with Scanner SDK for Android generated apps. It enables the host to establish a connection with the scanner over Classic Bluetooth radio. The scanner is in discoverable (Peripheral mode).

To establish a connection (initial setup only):

- i. Scan the **SSI BT Classic (Discoverable)** barcode.
- ii. From the host, discover Bluetooth devices.
- iii. Select your scanner from your discovered device list.

- **SSI BT LE** - Enables communication with Scanner SDK for iOS generated apps. It enables the host to establish a connection with the scanner over Bluetooth Low Energy radio. The scanner is in discoverable (Peripheral mode).

To establish a connection (initial setup only):

- i. Scan the **SSI BT LE** barcode.
- ii. From the host's application, select your scanner from the discovered device list.



SSI BT Classic (Non-Discoverable)



SSI BT Classic (Discoverable)



SSI BT LE

Serial Port Profile (SPP)

Select this host type when connecting to a PC/tablet/phone using a Bluetooth serial connection.

- **SPP BT Classic (Non-Discoverable)** - Enables the scanner to establish a Serial Port Profile (SPP) connection with the host over Classic Bluetooth radio. The scanner is NOT discoverable (Central mode). To establish a connection (initial setup only):
 - i. Scan the **SPP BT Classic (Non-discoverable)** barcode.
 - ii. Scan a pairing barcode with the MAC address of the host device.
- **SPP BT Classic (Discoverable)** - Enables the host to establish a Serial Port Profile (SPP) connection with the scanner over Classic Bluetooth radio. The scanner is discoverable (Peripheral mode). To establish a connection (initial setup only):
 - i. Scan the **SPP BT Classic (Discoverable)** barcode.
 - ii. From the host, discover Bluetooth devices.
 - iii. Select your scanner from the discovered device list.

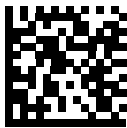

SPP BT Classic (Non-Discoverable)

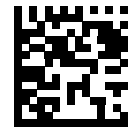

SPP BT Classic (Discoverable)

Bluetooth Technology Profile Support

With Bluetooth Technology Profile Support, the cradle is not required for wireless communication. The digital scanner communicates directly to the host using Bluetooth technology. The digital scanner supports the standard Bluetooth Serial Port Profile (SPP) and HID Profiles which enable the digital scanner to communicate with other Bluetooth devices that support these profiles.

- SPP - the digital scanner connects to the PC/host via Bluetooth and performs like there is a serial connection.
- HID - the digital scanner connects to the PC/host via Bluetooth and performs like a keyboard.

Central/Peripheral Set Up

The digital scanner can be set up as a Central or Peripheral. When the digital scanner is set up as a Peripheral, it is discoverable and connectible to other devices. When the digital scanner is set up as a Central, the Bluetooth address of the remote device to which a connection is requested is required. A pairing barcode with the remote device address must be created and scanned to attempt a connection to the remote device. See the [Pairing Bar Code Format on page 5-40](#) for information about creating a pairing barcode.

Central

When the digital scanner is set up as a Central (SPP), it initiates the radio connection to a peripheral device. Initiating the connection is done by scanning a pairing barcode for the remote device (see [Pairing Bar Code Format on page 5-40](#)).

Peripheral

When the digital scanner is set up as a Peripheral device (SPP), the digital scanner accepts an incoming connection request from a remote device.



NOTE The number of digital scanners is dependent on the host's capability.

Bluetooth Friendly Name

Parameter # 607 (F1h 5Fh)

- ✓ **NOTE** If the scanner was discovered previously by a PC/tablet/phone, it may take a while for the new name to appear as the PC/tablet/phone needs to update its list. Try turning the radio off and then on or reboot your PC/tablet/phone.

You can set a meaningful name for the digital scanner that appears in the application during device discovery. The default name is the digital scanner name followed by its serial number, e.g., **DS3678 123456789ABCDEF**. Scanning Set Defaults reverts the digital scanner to this name; use custom defaults to maintain the user-programmed name through a Set Defaults operation.

To set a new Bluetooth Friendly Name, scan the following barcode, then scan up to 23 characters from [Appendix G, Alphanumeric Bar Codes](#). If the name contains less than 23 characters, Then scan **End of Message** in the *Advanced Data Formatting Guide*.

- ✓ **NOTE** If your application allows you to set a device name, this takes precedence over the Bluetooth Friendly Name.



Bluetooth Friendly Name

Discoverable Mode

Parameter # 610 (F1h 62h)

Select a discoverable mode based on the device initiating discovery:

- Select **General Discoverable Mode** when initiating connection from a PC.
- Select **Limited Discoverable Mode** when initiating connection from a mobile device (e.g., iPhone), and the device does not appear in General Discoverable Mode. Note that it can take longer to discover the device in this mode.

The device remains in Limited Discoverable Mode for 30 seconds, and green LEDs flash while in this mode. It is then non-discoverable. To re-active Limited Discoverable Mode, press the trigger.



* **General Discoverable Mode**
(0)



Limited Discoverable Mode
(1)

Wi-Fi Friendly Mode

Parameter # 1299 (F8h 05h 13h)

Scanners configured for Wi-Fi friendly mode behave as follows:

- The scanner remains in sniff mode, and exits sniff mode only during firmware update.
- If any Wi-Fi channel is excluded from the hopping sequence, AFH turns off.
- Scanner (and cradle) avoid the selected Wi-Fi channels after establishing connection.

Notes

- If using this feature, configure all scanners in the area for Wi-Fi friendly mode.
- By default, no Wi-Fi channels are excluded.
- Since Bluetooth requires a minimum of 20 channels when Wi-Fi channels 1, 6, and 11 are excluded, a smaller number of channels are cut from the hopping sequence.
- Updating Wi-Fi friendly settings before Bluetooth connection is recommended.

Scan a barcode below to enable or disable **Wi-Fi Friendly Mode**, then see [Wi-Fi Friendly Channel Exclusion on page 5-14](#) to select any channels to exclude.



* Disable Wi-Fi Friendly Mode
(0)



Enable Wi-Fi Friendly Mode
(1)

Wi-Fi Friendly Channel Exclusion

Parameter # 1297 (F8h 05h 11h)

WiFi Channel Exclusion

Select the channels to exclude:

- **Exclude Wi-Fi channel 1:** Bluetooth channels 0-21 are excluded from hopping sequence (2402-2423 MHz).
- **Exclude Wi-Fi channel 6:** Bluetooth channels 25-46 are excluded from hopping sequence (2427 - 2448 MHz).
- **Exclude Wi-Fi channel 11:** Bluetooth channels 50-71 are excluded from hopping sequence (2452 - 2473 MHz).
- **Exclude Wi-Fi channel 1, 6 and 11:** Bluetooth channels 2-19 (2404-2421 MHz), 26-45 (2428 - 2447 MHz) and 51-69 (2453 - 2471 MHz) are excluded from hopping sequence.
- **Exclude Wi-Fi channels 1 and 6:** Bluetooth channels 0-21 (2402-2423 MHz) and 25-46 (2427 - 2448 MHz) are excluded from hopping sequence.
- **Exclude Wi-Fi channels 1 and 11:** Bluetooth channels 0-21 (2402-2423 MHz) and 50-71 (2452 - 2473 MHz) are excluded from hopping sequence.
- **Exclude Wi-Fi channel 6 and 11:** Bluetooth channels 25-46 (2427 - 2448 MHz) and 50-71 (2452 - 2473 MHz) are excluded from hopping sequence.



*** Use All Channels (Standard AFH)
(0)**

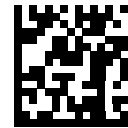

**Exclude Wi-Fi Channel 1
(1)**



**Exclude Wi-Fi Channel 6
(2)**



**Exclude Wi-Fi Channel 11
(3)**



Exclude Wi-Fi Channels 1, 6, and 11
(4)



Exclude Wi-Fi Channels 1 and 6
(5)

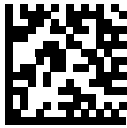

Exclude Wi-Fi Channels 1 and 11
(6)



Exclude Wi-Fi Channels 6 and 11
(7)

Radio Output Power

Parameter # 1324 (F8h 05h 2Ch)

The DS3678 uses a Class 1 Bluetooth radio. Optionally, reduce the radio's output power to restrict the transmission range and reduce the effect of the radio on neighboring wireless systems.

✓ **NOTE** Bluetooth stack resets on power change and the device loses connection.

Scan a barcode to select the desired power mode.



* High Power Setting
(0)



Medium Power Setting
(1)



Low Power Setting
(2)



Very Low Power Setting
(3)

Link Supervision Timeout

Parameter # 1698 (F8h 06h A2h)

Link supervision timeout controls how quickly the scanner senses that the Bluetooth radio lost connection to the remote device. A lower value helps prevent data loss at the edge of the operating range while a larger value helps prevent disconnects due to the remote device not responding in time. If you are experiencing occasional disconnects and the scanner is able to reconnect, increase the link supervision timeout value.

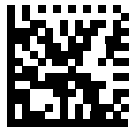

**.5 Seconds
(800)**

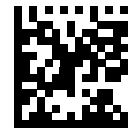

**2 Seconds
(3200)**



*** 5 Seconds
(8000)**

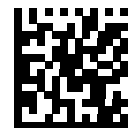

**10 Seconds
(16000)**

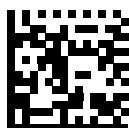

**20 Seconds
(32000)**

Bluetooth Radio State

Parameter # 1354 (F8h 05h 4Ah)



NOTE The radio on/off parameters are for both scanner and cradle. If the scanner is NOT connected to the cradle, the scanner's radio will turn off. If the scanner is connected to the cradle, both the scanner and cradle radios will be turned off.

If the cradle radio is turned off, the only options to turn the cradle radio back on is via host command or using Parameter Batch Mode.

When more than one scanner is paired with the cradle in *Multipoint-to-Point Communication* mode, scanning Bluetooth Radio Off disconnects all scanners. The disconnect beep is heard only on the scanner that scanned the Bluetooth Radio Off parameter (not on the remaining scanners that are paired with cradle).



**Bluetooth Radio Off
(0)**



*** Bluetooth Radio On
(1)**

HID Host Parameters

The digital scanner supports virtual keyboard emulation for the Apple iOS, and keyboard emulation over the Bluetooth HID profile. In this mode the digital scanner can interact with Bluetooth enabled hosts supporting the HID profile as a Bluetooth keyboard. Scanned data is transmitted to the host as keystrokes.

Apple iOS Virtual Keyboard Toggle

Parameter # 1114 (F8h 04h 5Ah)

This option works with Apple iOS devices to enable the opening and closing of the iOS virtual keyboard by double-pressing the trigger.

✓ **NOTE** When this feature is enabled, the digital scanner may be incompatible with non-Apple iOS devices.



* Disable
(0)



Enable
(1)

HID Keyboard Keystroke Delay

This parameter sets the delay, in milliseconds (msec), between emulated keystrokes. Scan a barcode below to increase the delay when the HID host requires a slower transmission of data.



* No Delay (0 msec)



Medium Delay (20 msec)



Long Delay (40 msec)

HID CAPS Lock Override

When enabled, the case of the data is preserved regardless of the state of the caps lock key. This setting is always enabled for the *Japanese, Windows (ASCII)* keyboard type and can not be disabled.



* Do Not Override Caps Lock Key
(Disable)



Override Caps Lock Key
(Enable)

HID Ignore Unknown Characters

This option applies only to the HID Keyboard Emulation device and IBM device. Unknown characters are characters the host does not recognize. When Send Bar Codes With Unknown Characters is selected, all barcode data is sent except for unknown characters, and no error beeps sound. When Do Not Send Bar Codes With Unknown Characters is selected, barcode data is sent up to the first unknown character, then the digital scanner issues an error beep.



*** Send Bar Codes With Unknown Characters
(Enable)**



**Do Not Send Bar Codes With Unknown Characters
(Disable)**

Emulate Keypad

When enabled, all characters are sent as ASCII sequences over the numeric keypad. For example, ASCII A is sent as "ALT make" 0 6 5 "ALT Break".



Disable Keypad Emulation



*** Enable Keypad Emulation**

Fast HID Keyboard

Parameter # 1361 (F8h 05h 15h)

This option transmits Bluetooth HID keyboard data at a faster rate.



Fast HID Disable
(0)



* Fast HID Enable
(1)

Quick Keypad Emulation

Parameter # 1362 (F8h 05h 52h)

✓ **NOTE** This option applies only to a HID Keyboard Emulation Device which has **Emulate Keypad** enabled (see [Emulate Keypad on page 5-22](#)).

This parameter enables a quicker method of keypad emulation where ASCII sequences are only sent for ASCII characters not found on the keyboard.

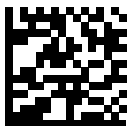

Quick Keypad Emulation Disable
(0)



* Quick Keypad Emulation Enable
(1)

HID Keyboard FN1 Substitution

When enabled, this parameter allows replacement of any FN1 character in an EAN128 barcode with a Key Category and value chosen by the user. See [FN1 Substitution Values on page 6-45](#) to set the Key Category and Key Value.



* **Disable Keyboard FN1 Substitution**



Enable Keyboard FN1 Substitution

HID Function Key Mapping

ASCII values under 32 are normally sent as control-key sequences. When this parameter is enabled, the keys in bold are sent in place of the standard key mapping (see [Table I on page I-1](#)).

Table entries that do not have a bold entry remain the same whether or not this parameter is enabled.



* **Disable Function Key Mapping**



Enable Function Key Mapping

Simulated Caps Lock

When enabled, the digital scanner inverts upper and lower case characters on the digital scanner barcode as if the Caps Lock state is enabled on the keyboard. This inversion is done regardless of the current state of the keyboard Caps Lock state.

✓ **NOTE** This feature is ignored if **Convert All to Upper Case** or **Convert All to Lower case** is enabled.



* **Disable Simulated Caps Lock**



Enable Simulated Caps Lock

Convert Case

When enabled, the digital scanner converts all barcode data to the selected case.



* **No Case Conversion**



Convert All to Upper Case



Convert All to Lower Case

Reconnect Attempt Beep Feedback

When in SPP Central, Cradle Host Mode, and Bluetooth Keyboard Emulation, the digital scanner automatically tries to reconnect to a remote device when a disconnection occurs that is due to the radio losing communication. This can happen if the digital scanner goes out of range with the remote device, or if the remote device powers down. The digital scanner tries to reconnect for the period of time specified by the Reconnect Attempt Interval setting. During that time the green LED continues to blink.

If the auto-reconnect process fails due to page time-outs, the digital scanner sounds a page timeout beep (long low/long high) and enters low power mode. The auto-reconnect process can be re-started by pulling the digital scanner trigger.

If the auto-reconnect process fails because the remote device rejects the connection attempt, the digital scanner sounds a connection reject beep sequence (see [Wireless Beeper Definitions on page 5-5](#)) and deletes the remote pairing address. If this happens, a pairing barcode must be scanned to attempt a new connection to the remote device.

- ✓ **NOTE** If a barcode is scanned while the auto-reconnect sequence is in process, a transmission error beep sequence sounds and the data is not transmitted to the host. After a connection is reestablished, normal scanning operation returns. For error beep sequence definitions, see [DS3678 Scanner Beeper and LED Definitions on page 3-2](#).

The digital scanner has memory available for storing a remote Bluetooth address for each Central mode (SPP, Cradle). When switching between these modes, the digital scanner automatically tries to reconnect to the last device it was connected to in that mode.

- ✓ **NOTE** Switching between Bluetooth host types by scanning a host type barcode ([page 5-5](#)) causes the radio to be reset. Scanning is disabled during this time. It takes several seconds for the digital scanner to re-initialize the radio at which time scanning is enabled.

Reconnect Attempt Beep Feedback

Parameter # 559 (F1h 2Fh)

When a digital scanner disconnects as it goes out of range, it immediately attempts to reconnect. While the digital scanner attempts to reconnect, the green LED continues to blink. If the auto-reconnect process fails, the digital scanner emits a page timeout beep (long low/long high) and stops blinking the LED. The process can be restarted by pulling the trigger.

The Beep on Reconnect Attempt feature is disabled by default. When enabled, the digital scanner emits 5 short high beeps every 5 seconds while the re-connection attempt is in progress. Scan a barcode below to enable or disable Beep on Reconnect Attempt.

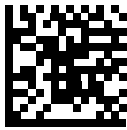

*** Disable Beep on Reconnect Attempt
(0)**



**Enable Beep on Reconnect Attempt
(1)**

Reconnect Attempt Interval

Parameter # 558 (F1h 2Eh)

When a digital scanner disconnects as it goes out of range, it immediately attempts to reconnect for the default time interval of 30 seconds. This time interval can be changed to one of the options below.

To set the Reconnect Attempt Interval, scan one of the barcodes below.



* Attempt to Reconnect for 30 Seconds
(6)



Attempt to Reconnect for 1 Minute
(12)

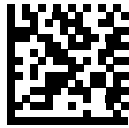

Attempt to Reconnect for 5 Minutes
(60)



Attempt to Reconnect for 30 Minutes
(360)



Attempt to Reconnect for 1 Hour
(720)



Attempt to Reconnect Indefinitely
(0)

Auto-reconnect

Parameter # 604 (F1h 5Ch)

In Bluetooth Keyboard Emulation (HID) mode, SPP Central, and Cradle Host Mode, select a re-connect option for when the digital scanner loses its connection with a remote device:

- **Auto-reconnect on Bar Code Data:** The digital scanner auto-reconnects when you scan a barcode. With this option, a delay can occur when transmitting the first characters. The digital scanner sounds a decode beep upon barcode scan, followed by a connection, a page timeout, a rejection beep, or a transmission error beep. Select this option to optimize battery life on the digital scanner and mobile device. Note that auto-reconnect does not occur on rejection and cable unplug commands.
- **Auto-reconnect Immediately:** When the digital scanner loses connection, it attempts to reconnect. If a page timeout occurs, the digital scanner attempts reconnect on a trigger pull. Select this option if the digital scanner's battery life is not an issue and you do not want a delay to occur when the first barcode is transmitted. Note that auto-reconnect does not occur on rejection and cable unplug commands.
- **Disable Auto-reconnect:** When the digital scanner loses connection, you must re-establish it manually.



**Auto-reconnect on Bar Code Data
(1)**



*** Auto-reconnect Immediately
(2)**

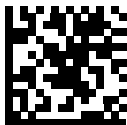

**Disable Auto-reconnect
(0)**

Sleep Between Attempts

Parameter # 1778 (SSI # F8h 06h F2h)

Scan a barcode below to reduce potential Wi-Fi interference and extend scanner battery life by allowing the scanner to go to sleep (low power mode) for the time indicated between reconnect attempts.



NOTE This feature only works when low power mode is enabled on the scanner and when the scanner is not charging in the cradle.

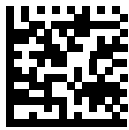

Sleep for 30 Seconds
(30)



*Sleep for 1 Minute
(60)



Sleep for 2 Minutes
(120)



Sleep for 5 Minutes
(300)



**Sleep for 30 Minutes
(1800)**

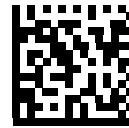

**Sleep for 1 Hour
(3600)**

Number of Retry Attempts

Parameter # 1779 (SSI # F8h 06h F3h)

Scan a barcode below to control how many reconnect and associated sleep attempts to execute. After the number of retries is reached, the scanner no longer attempts to reconnect to the host.



NOTE After the retry period expires, if the trigger is pulled, the scanner restarts the auto-reconnect and sleep sequence.



*** Do Not Retry
(0)**



**Retry 5 Times
(5)**



**Retry 10 Times
(10)**

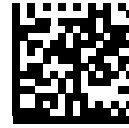

**Retry 20 Times
(20)**



**Retry 40 Times
(40)**

Out of Range Indicator

An out of range indicator can be set by scanning [Enable Beep on Reconnect Attempt \(1\) on page 5-27](#) and extending the time using the [Reconnect Attempt Interval on page 5-28](#).

For example, with Beep on Reconnect Attempt disabled while the digital scanner loses radio connection when it is taken out of range, the digital scanner attempts to reconnect silently during the time interval set by scanning a Reconnect Attempt Interval.

When Beep on Reconnect Attempt is enabled, the digital scanner emits 5 high beeps every 5 seconds while the re-connection attempt is in progress. If the Reconnect Attempt Interval is adjusted to a longer period of time, such as 30 minutes, the digital scanner emits 5 high beeps every 5 seconds for 30 minutes providing an out of range indicator.

Beep on Insertion

Parameter # 288 (120h)

When a digital scanner is inserted into a cradle and detects power, it emits a short low beep. This feature is enabled by default.

To enable or disable beeping on insertion, scan the appropriate barcode below.



*** Enable Beep on Insertion
(1)**



**Disable Beep on Insertion
(0)**

Digital Scanner(s) To Cradle Support

Modes of Operation

Parameter # 538 (F1h 1Ah)

The charging cradle with radio supports two radio communication modes of operation, allowing the digital scanner to communicate wirelessly:

- Point-to-Point
- Multipoint-to-Point.

Point-to-Point Communication

In Point-to-Point communication mode, the cradle allows one digital scanner to connect to it at a time. In this mode, the digital scanner is paired to the cradle either by insertion into the cradle (if pairing on contacts is enabled, [page 5-38](#)), or by scanning the PAIR barcode. Communication can be locked, unlocked (default), or in a lock override state (see [Pairing Modes on page 5-37](#)). In locked mode, locking intervals must be set by scanning a connection maintenance interval barcode beginning on [page 5-40](#).

To activate this mode of operation, scan Point-to-Point.

Multipoint-to-Point Communication

Multipoint-to-Point communication mode allows up to seven digital scanners to pair to one cradle.

To activate this mode, the first digital scanner connected to the cradle must scan the Multipoint-to-Point barcode. This mode allows a parameter broadcast ([page 5-36](#)) feature that forwards parameter barcode settings to all connected digital scanners. In this mode, programming one digital scanner applies the settings to all connected digital scanners.

To select Point-to-Point or Multipoint-to-Point mode, scan the appropriate barcode.



Multipoint-to-Point Mode
(1)



*** Point-to-Point Mode**
(0)

Parameter Broadcast (Cradle Host Only)

Parameter # 148 (94h)

- ✓ **NOTE** When Parameter Broadcast is disabled on one scanner in the piconet, **Parameter Broadcast** is disabled on all scanners in the piconet.

When in multipoint-to-point mode, enable Parameter Broadcast to broadcast all parameter barcodes scanned to all other digital scanners in the piconet. If disabled, parameter barcodes are processed by the individual digital scanner only, and the digital scanner ignores parameters broadcast from other digital scanners or from the cradle.



* **Enable Parameter Broadcast**
(1)



Disable Parameter Broadcast
(0)

Pairing

Pairing is the process by which a digital scanner initiates communication with a cradle. Scanning Multipoint-to-Point activates multi digital scanner-to-cradle operation and allows up to seven digital scanners to pair to one cradle.

To pair the digital scanner with the cradle, scan the pairing barcode. A high/low/high/low beep sequence indicates that the pairing barcode was decoded. When a connection between the cradle and digital scanner is established, a low/high beep sounds.

- ✓ **NOTE**
1. The pairing barcode that connects the digital scanner to a cradle is unique to each cradle.
 2. Do not scan data or parameters until pairing completes.
 3. Only when the digital scanner is paired to the cradle, it automatically tries to reconnect to a remote device when a disconnection occurs that is due to the radio losing communication. For more information see [Reconnect Attempt Beep Feedback on page 5-26](#).

Pairing Modes

Parameter # 542 (F1h 1Eh)

When operating with the cradle, two modes of pairing are supported:

- **Locked Pairing Mode** - When a cradle is paired (connected) to the digital scanner (or up to seven digital scanners in Multipoint-to-Point mode), any attempt to connect a different digital scanner, by either scanning the **PAIR** barcode on the cradle or by inserting it into the cradle with the pairing on contacts feature enabled ([page 5-38](#)), is rejected. The currently connected digital scanner(s) maintain connection. In this mode, you must set a [Connection Maintenance Interval on page 5-40](#).
- **Unlocked Pairing Mode** - Unlocking works in Point-to-Point mode only. Pair (connect) a new digital scanner to a cradle at any time by either scanning the **PAIR** barcode on the cradle or by inserting it into the cradle with the pairing on contacts feature enabled. This unpairs the previous digital scanner from the cradle.

To set the cradle pairing mode, scan the appropriate barcode below.



* Unlocked Pairing Mode
(0)



Locked Pairing Mode
(1)

Lock Override

- ✓ **NOTE** Lock Override is applicable in Point-to-Point mode only (does not apply to Multipoint-to-Point mode). In Multipoint-to-Point mode, if seven scanners are connected, the scanners must be disconnected for a new scanner to connect.

Lock Override overrides a locked digital scanner base pairing and connects a new digital scanner. To use Lock Override, scan the barcode below, followed by the pairing barcode on the cradle.



Lock Override

Pairing Methods

Parameter # 545 (F1h 21h)

There are two methods available to pair (connect) the digital scanner to the cradle:

- Scan the pairing barcode on the cradle
- or
- Pair on contacts by inserting the scanner into the cradle.

When the Bluetooth connection beeps sound, the scanner and cradle connect. See [Wireless Beeper Definitions on page 5-5](#) for other beep sequences.

Enable or disable **Pair on Contacts** by scanning the appropriate barcode below.



NOTE When **Pair on Contacts** is enabled you may still scan the pairing barcode on the cradle. You can enable or disable **Pair on Contacts** for the cradle type by scanning the appropriate barcode below.

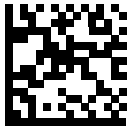

* **Enable Pair On Contacts**
(1)



Disable Pair on Contacts
(0)

Pull Trigger Twice to Re-connect



IMPORTANT This feature only applies to hosts capable of a commanded connection; SPP Peripheral and HID BLE hosts do not support this feature.

Upon a double trigger press, the digital scanner attempts to connect to the last known address. This feature differs from auto-reconnect (see [Reconnect Attempt Beep Feedback on page 5-26](#)) in that the digital scanner attempts connection only once and keeps the address even on commanded disconnect. The last known address is only cleared upon a reject or with a new successful connection. The address persists over scanner reboot.



NOTE This feature does not interfere with a double trigger press to open/close an iOS keypad in HID mode.

Unpairing

Unpair the digital scanner from the cradle or PC/host to make the cradle available for pairing with another digital scanner. Scan the barcode below to disconnect the digital scanner from its cradle/PC host.

An unpairing barcode is also included in the *DS3678 Quick Reference Guide*.

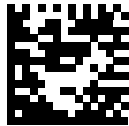

Unpairing

Toggle Pairing

Parameter # 1322 (F8h 05h 2Ah)

If the scanner is configured for Toggle Pairing, scanning the Toggle Pairing barcode a second time will unpair the scanner.



*** Toggle Pairing Disable
(0)**



**Toggle Pairing Enable
(1)**

Pairing Bar Code Format

Scan-To-Connect (STC) Utility

In one step, connect your Zebra Bluetooth scanner to a phone, tablet or PC by scanning a STC barcode. Available as a standalone utility, the supported operating systems include:

- Windows
- Android

For more information go to zebra.com/scantoconnect. Source code is also available for easy app integration.

Connection Maintenance Interval

✓ **NOTE** The Connection Maintenance Interval only applies in locked pairing mode (see [page 5-37](#)).

When a digital scanner disconnects from a cradle due to a Link Supervision Timeout, the digital scanner immediately attempts to reconnect to the cradle for 30 seconds. If the auto-reconnect process fails, it can be restarted by pulling the digital scanner trigger.

To guarantee that a disconnected digital scanner can reconnect when it comes back in range, the cradle reserves the connection for that digital scanner for a period of time defined by the Connection Maintenance Interval. If the cradle is supporting the maximum seven digital scanners and one digital scanner disconnects, an eighth digital scanner cannot pair to the cradle during this interval. To connect another digital scanner: either wait until the connection maintenance interval expires then scan the PAIR barcode on the cradle with the new digital scanner; or, scan Lock Override ([page 5-37](#)) with the new digital scanner then scan the PAIR barcode on the cradle.

✓ **NOTE** The cradle stores the remote pairing address of each digital scanner in memory regardless of the digital scanner condition (e.g., discharged battery). When you want to change the digital scanners paired to the cradle, unpair each digital scanner currently connected to the cradle by scanning the [Unpairing](#) barcode prior and reconnect each appropriate digital scanner by scanning the PAIR barcode on the cradle.

Considerations

The system administrator determines the Connection Maintenance Interval. A shorter interval allows new users to gain access to abandoned connections more quickly, but causes problems if users leave the work area for extended periods. A longer interval allows existing users to leave the work area for longer periods of time, but ties up the system for new users.

To avoid this conflict, users who are going off-shift can scan the unpair barcode on [page 5-39](#) to ignore the Connection Maintenance Interval and make the connection immediately available.

Connection Maintenance Interval (continued)

To set the Connection Maintenance Interval, scan one of the barcodes below.

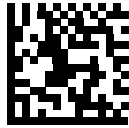

*** Set Interval to 15 Minutes
(0)**



**Set Interval to 30 Minutes
(1)**



**Set Interval to 60 Minutes
(2)**



**Set Interval to 2 Hours
(3)**

Connection Maintenance Interval (continued)



Set Interval to 4 Hours
(4)

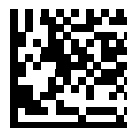

Set Interval to 8 Hours
(5)



Set Interval to 24 Hours
(6)

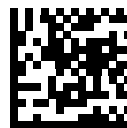

Set Interval to Forever
(7)

AutoConfig (Scanner Cloning Through Cradle)

Parameter # 2139 (SSI # F8 08 5B)

This parameter controls scanner cloning through the cradle. When this parameter is enabled, the cradle's stored scanner parameters are transmitted to the DS3678 upon pairing to the cradle, configuring the DS3678 with updated parameters. This allows the scanner to be automatically configured for a new host application, use case, or workflow. This feature is disabled by default.

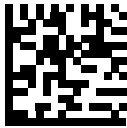

* Disable
(0)



Enable
(1)

The cradle's configuration of the scanner is limited to the following scanner parameters:

- All Symbologies Parameters (see [Chapter 13, Symbologies](#))
- Advanced Data Formatting rules (see [Advanced Data Formatting \(ADF\) on page 16-1](#))
- Multicode Rules (see [Multicode Data Formatting \(MDF\) on page 16-1](#))
- Picklist Mode (see [Picklist Mode on page 6-26](#))
- Digimarc Digital Watermarks (see [Digimarc Digital Watermarks on page 15-2](#))
- Reconnect Attempt Beep Feedback (see [Reconnect Attempt Beep Feedback on page 5-27](#)).



NOTE When AutoConfig (Scanner Cloning Through Cradle) is enabled, scanning is disabled for up to 3 to 5 seconds while the configuration is being uploaded to the scanner. The green LED blinks during this period.

Any pre-programmed scanner settings listed above are overwritten and lost once AutoConfig (Scanner Cloning Through Cradle) is performed by pairing the scanner and cradle.

AutoConfig (Scanner Cloning Through Cradle) is not supported in Multi-Point.

Cradle Configuration

The cradle can be configured using one of the following methods:

- 123Scan
- Parameter bar codes

✓ **NOTE** The scanner must be paired to the cradle when performing parameter bar code scanning for it to persist and be loaded in the future AutoConfig (Scanner Cloning Through Cradle) sessions.

- A Zebra Scanner SDK generated application.
- SMS

Batch Mode

Parameter # 544 (F1h 20h)



IMPORTANT Batch mode does not apply to SPP Peripheral Mode.

The digital scanner supports five versions of batch mode. When the digital scanner is configured for any of the batch modes, it attempts to store barcode data (not parameter barcodes) until transmission is initialized, or the maximum number of barcodes are stored. When a barcode is saved successfully, a good decode beep sounds and the LED flashes green. If the digital scanner is unable to store a new barcode, a low/high/low/high out of memory beep sounds. (See page 3-1 for all beeper and LED definitions.)

In all modes, calculate the amount of data (number of barcodes) the digital scanner can store as follows:

Number of storable barcodes = 30,720 bytes of memory / (number of characters in the barcode + 3).

- ✓ **NOTE** If the batch mode selection is changed while there is batched data, the new batch mode takes effect only after all the previously batched data is sent.

Modes of Operation

- **Normal (default)** - Do not batch data. The digital scanner attempts to transmit every scanned barcode.
- **Out of Range Batch Mode** - The digital scanner starts storing barcode data when it loses its connection to a remote device (for example, when a user holding the digital scanner walks out of range). Data transmission is triggered by reestablishing the connection with the remote device (for example, when a user holding the digital scanner walks back into range).

- ✓ **NOTE** Do not use **Out of Range Batch Mode** together with the **Auto-Reconnect on Bar Code Data** (see [Auto-reconnect on page 5-30](#)). If used together, the decoded scanned data is batched and does not allow the scanner to reconnect.

- **Standard Batch Mode** - The digital scanner starts storing barcode data after **Enter Batch Mode** is scanned. Data transmission is triggered by scanning **Send Batch Data**.

- ✓ **NOTE** Transmission is halted if the connection to the remote device is lost.

- **Cradle Contact Batch Mode** - The digital scanner starts storing barcode data when **Enter Batch Mode** is scanned. Data transmission is triggered by insertion of the digital scanner into the cradle.

- ✓ **NOTE** If the digital scanner is removed from the cradle during batch data transfer, transmission halts until the digital scanner is re-inserted in the cradle.

- **Batch Only Mode** - The scanner radio is turned off and the scanner stores all barcode data. Data transmission is triggered by insertion of the scanner into the cradle.

- ✓ **NOTE** If the digital scanner is removed from the cradle during batch data transfer, transmission halts until the digital scanner is re-inserted in the cradle.

The radio may be turned off as batch data is transmitted over the cradle contacts.

This mode can only be exited by scanning **Normal** (default) mode.

- **Parameter Batch Mode** - When **Parameter Batch Mode** is entered and no connection to the cradle exists, the scanner begins storing parameter barcode data intended for the cradle. Parameter barcode transmission is triggered by insertion of the scanner into the cradle. Parameter Batch Mode is exited upon the end of the transmission. Alternatively, parameter barcode batching may be cancelled prior to insertion of the scanner into

the cradle by scanning **Exit Parameter Batch Mode**.

Parameter Batch Mode may be used when the cradle and/or scanner is configured with its radio turned off or connected to a non-cradle device.



* Normal
(0)



Out of Range Batch Mode
(1)



Standard Batch Mode
(2)



Cradle Contact Batch Mode
(3)

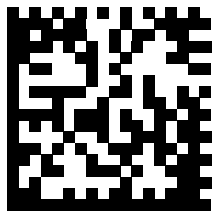

Enter Batch Mode

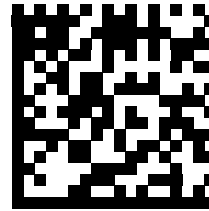

Send Batch Data

Batch Mode (continued)



Batch Only Mode

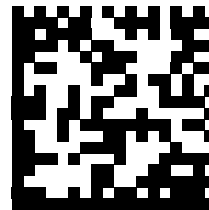

Enter Parameter Batch Mode

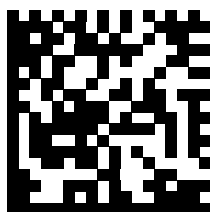

Exit Parameter Batch Mode

Persistent Batch Storage

Parameter #1399 (F8h 05h 77h)

When the scanner is configured for Persistent Batch Storage, batch data is stored in non-volatile memory and preserved even when the digital scanner is powered down. This parameter is Disabled by default.



NOTE Frequently storing batch data with this setting *Enabled* will shorten the life of the non-volatile memory.



* Persistent Batch Disable
(0)



Persistent Batch Enable
(1)

Page Button

Parameter # 746 (F1h EAh)

The cradle offers a page button. The page button is a sensor that when touched, causes paired scanners to emit a beeping sequence. The default is Enable Page Button.

1. Place your finger over the page button sensor.
2. Press down for approximately 1 second.
3. The cradle LED will turn blue when the scanner is out of the cradle. The paired scanner will beep, blink, and vibrate. If multiple scanners are paired to the cradle, all the scanners will beep, blink, and vibrate.
4. Repeat as necessary.

✓ **NOTE** Scanners out of radio range will not beep when paged. Refer to [Technical Specifications on page 4-7](#) for detailed radio range information.

Scan one of the following barcodes to enable or disable this feature.



**Disable Page Button
(0)**



*** Enable Page Button
(1)**

Page Options

To select a page option, select one of the barcodes below.

Page Mode

Parameter # 1364 (F8h 05h 54h)

- **Page State** - In this mode, the cradle sends a page state request to each scanner. It remains in Page State indication until every scanner sends an acknowledgment.

The scanner enters Page State when the LED indicator is blinking blue and the vibrator and beeper is activated. When the trigger is pressed, or the scanner is inserted into the cradle, or the requested timeout (default is 30 seconds) is reached, the scanner sends the acknowledgment to the cradle and returns to its normal state.

- **Page Simple** - In this mode, the cradle sends a page indication request to each scanner, and returns to idle state. Each scanner issues a single Page State indication.



Page State
(1)



*** Page Simple**
(0)

Page State Timeout

Parameter # 1365 (F8h 05h 55h)

Page timeout is programmable in 1 second increments from 1 to 99 seconds. The default timeout is 30 seconds.

✓ **NOTE** Page State Timeout only applies to **Page State Mode**.

To set a page timeout:

1. Scan the **Page Timeout** barcode below.
2. Scan two numeric barcodes from [Appendix H, Numeric Bar Codes](#) that correspond to the desired timeout duration. Enter a leading zero for single digit numbers (for example, for a 5 second page timeout, scan the 0 barcode and then the 5 barcode).

To correct an error or change the selection, scan [Cancel on page H-2](#).

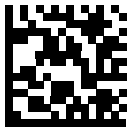

Page Timeout

Bluetooth Security

The digital scanner supports Bluetooth Authentication. Authentication can be requested by either the remote device or the digital scanner.

✓ **NOTE** A remote device can still request Authentication.

PIN Code

Parameter # 552 (F1h 28h)

To set and store a PIN code (e.g., password) on the digital scanner to connect to the host:

1. Scan the **Set & Store PIN Code** barcode below.
2. Scan five alphanumeric programming barcodes using the alphanumeric barcodes beginning on [page G-1](#).
3. Scan **End of Message** in the *Advanced Data Formatting Guide*.

The default PIN code is 12345.

If the digital scanner communicates with a host with enabled, synchronize the PIN codes on the digital scanner and host. To achieve this, connect the digital scanner to the host when setting the PIN codes. If the digital scanner is not connected to a host, the PIN code change only takes affect on the digital scanner. If is required between the digital scanner and host, and the PIN codes do not match, pairing fails.

✓ **NOTE** An extended 16 character PIN code is available for additional with Open Bluetooth (SPP and HID).



Set and Store PIN Code

Variable PIN Code

Parameter # 608 (F1h 60h)

When switching to Cradle Host mode with authentication enabled, scan Static PIN Code below to avoid entering the PIN code manually. The PIN stored in memory is used. Scan the Variable PIN Code below to manually enter a PIN code with each connection.

The default PIN code is the user-programmed PIN set and stored above. Typically, however, HID connections require entering a Variable PIN Code. If, when attempting connection, the application presents a text box that includes a PIN, scan the Variable PIN Code barcode, then re-attempt connection. When you hear a beep indicating the digital scanner is waiting for an alphanumeric entry, enter the provided variable PIN using the [Alphanumeric Bar Codes on page G-1](#), then scan **End of Message** in the *Advanced Data Formatting Guide*. If the code is less than 16 characters. The digital scanner discards the variable PIN code after connection.



* Static PIN Code
(0)



Variable PIN Code
(1)

Bluetooth Security Levels

Parameter # 1393 (F8h 05h 71h)

- **Low Bluetooth Security** - The low security setting is designed for ease of connection with most devices. This setting may be unacceptable to some devices. If connection fails, try re-connecting after increasing security setting on the scanner.

If connecting to Bluetooth 2.1 device and above, *Just Works* method for secure and simple pairing is used.

✓ **NOTE** Data is encrypted using the **Low Bluetooth** security setting if connected to a Bluetooth 2.1 and above device.

- **Medium Bluetooth Security** - The medium security setting may require a passkey for the initial connection to pair scanner and device. If connecting to Bluetooth 2.1 device and above, *Passkey Entry* method for secure and simple pairing is used.
- **High Bluetooth Security** - The high security setting enables *Man in the Middle* protection for Bluetooth 2.1 and above. Not all devices are able to support this mode.
- **Legacy Bluetooth Security** (Bluetooth 2.0 and below) - The legacy security setting enables authentication and encryption for legacy pairing.

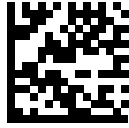

*** Low Bluetooth Security
(0)**



**Medium Bluetooth Security
(1)**

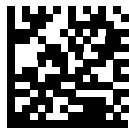

**High Bluetooth Security
(2)**



**Legacy Bluetooth Security
(3)**

Save Bluetooth Connection Information

Parameter # 1743 (F8h 06h CFh)

- ✓ **NOTE** Depending on the auto-reconnect settings, the scanner reconnects when going out of range and other conditions where connection is lost, but auto-reconnect is desired.
- **Enable (default)** - The scanner saves the last connection and attempts to reconnect after battery swap (power cycle) if it is set to auto-reconnect. See [Auto-reconnect on page 5-30](#).
 - **Disable** - The scanner does not save the last connection to permanent memory and does not reconnect after battery swap (power cycle).



* Save Bluetooth Connection Information
(Enable)



Save Bluetooth Connection Information
(Disable)

Virtual Tether

Virtual Tether feature allows the scanner, cradle or host application to alert users when Bluetooth connection is lost. It works by independently controlling the scanner's illumination, audio, haptics, and LEDs.

To adjust the range of the scanner and cradle connection, change the radio power (high, medium, low). See [Radio Output Power on page 5-17](#) for more information.

Configuring the Alarm on the Scanner

Parameter # 2053 (F8h 08h 05h)

The Virtual Tether alarm on the scanner:

- The alarm includes audio, LED, illumination, and haptic.
- Each Alarm Type (Audio, LED, Illumination, Haptic) can be enabled or disabled using the bar codes in this section. This allows for creation of custom alarms.
- The scanner vibrates when the alarm activates.
- This feature is disabled by default.



* **Disable Virtual Tether Alarm on the Scanner**
(0)



Enable Virtual Tether Alarm on the Scanner
(1)

Audio Virtual Tether Alarm on Scanner

Parameter # 2246 (F8h 08h C6h)

Scan the bar codes below to disable or enable the Audio Virtual Tether Alarm on the scanner. When the Virtual Tether is enabled, the audio beeper sounds at high volume.



**Disable Audio Virtual Tether Alarm
(0)**



*** Enable Audio Virtual Tether Alarm
(1)**

LED Virtual Tether Alarm on Scanner

Parameter # 2247 (F8h 08h C7h)

Scan the bar codes below to disable or enable the LED Virtual Tether Alarm on the scanner. When enabled, the scanner LEDs blink green and red.

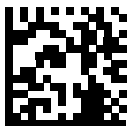

**Disable LED Virtual Tether Alarm
(0)**



*** Enable LED Virtual Tether Alarm
(1)**

Illumination Virtual Tether Alarm on Scanner

Parameter # 2248 (F8h 08h C8h)

Scan the bar codes below to disable or enable the Illumination Virtual Tether Alarm on the scanner.



**Disable Illumination Virtual Tether Alarm
(0)**



*** Enable Illumination Virtual Tether Alarm
(1)**

Haptic Virtual Tether Alarm on Scanner

Parameter # 2249 (F8h 08h C9h)

Scan the bar codes below to disable or enable the Haptic Virtual Tether Alarm on the scanner.



**Disable Haptic Virtual Tether Alarm
(0)**



*** Enable Haptic Virtual Tether Alarm
(1)**

Virtual Tether Alarm on the Cradle

Parameter # 2124 (F8h 08h 4Ch)

Scan the bar codes below to disable or enable the Virtual Tether Alarm on the cradle. When enabled, the cradle LEDs blink green and red.



* **Disable Virtual Tether Alarm on the Cradle**
(0)



Enable Virtual Tether Alarm on the Cradle
(2)

Delay Before Virtual Alarm Activates

Parameter # 2054 (F8h 08h 06h)

When the device is out of range, it holds off on sounding the Virtual Tether alarm to provide an opportunity to re-establish a connection (5 - 99 seconds). The default is 30 seconds.



NOTE Ensure that this setting is not too short in order to avoid the following:

- If the cradle resets, it causes the scanner to activate the Virtual Tether alarm.
- Noisy RF environments can lead to frequent, momentary disconnect/reconnect sequences.

To set a timeout:

1. Scan the **Delay Before Alarm Activates** bar code.
2. Scan two bar codes from [Appendix H, Numeric Bar Codes](#) that correspond to the desired timeout duration. Enter a leading zero for single digit numbers (for example, for an alarm to start after 5 seconds, scan the 0 bar code and then the 5 bar code).

To correct an error or change the selection, scan [Cancel on page H-2](#).



Delay Before Alarm Activates

Virtual Tether Alarm Duration

Parameter # 2055 (F8h 08h 07h)

Set up the amount of time for the Alarm to play in minutes (1 - 99 minutes). The default is 5 minutes.

To set a timeout:

1. Scan the **Alarm Duration** bar code.
2. Scan two bar codes from [Appendix H, Numeric Bar Codes](#) that correspond to the desired alarm duration. Enter a leading zero for single digit numbers (for example, for an alarm to start after 5 minutes, scan the 0 bar code and then the 5 bar code). The value of zero sets the duration to **Infinite**.

To correct an error or change the selection, scan [Cancel on page H-2](#).

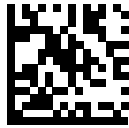

Alarm Duration

Stopping the alarm

The alarm stops once the connection is established, the timeout period expires, or the scanner's battery is drained.



NOTE Any connection stops the alarm. The scanner does not need to connect to the same cradle.

Defeat Virtual Tether Alarm

Parameter # 2119 (F8h 08h 47h)

Pressing the trigger on the scanner can be configured to defeat or pause the alarm.

The cradle Page Button is used to defeat or pause the alarm.



**Do Not Defeat Alarm
(0)**



*** Pause Alarm on Trigger Pull/Page Button
(1)**

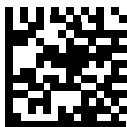

**Stop Alarm on Trigger Pull/Page Button
(2)**

Pause Virtual Tether Alarm Duration

Parameter # 2120 (F8h 08h 48h)

Pressing the Scan Button on the scanner pauses the alarm for a programmable number of seconds (1 - 99 seconds). The default is **30 seconds**.

To set a timeout:

1. Scan the **Pause Virtual Tether Alarm Duration** bar code.
2. Scan two bar codes from [Appendix H, Numeric Bar Codes](#) that correspond to the desired alarm duration. Enter a leading zero for single digit numbers (for example, for an alarm to start after 5 seconds, scan the 0 bar code and then the 5 bar code).

To correct an error or change the selection, scan [Cancel on page H-2](#).



Pause Virtual Tether Alarm Duration

Virtual Tether Alarm Considerations

- Causes for the alarm to activate include:
 - Device going out of range. Depending on configuration, both scanner and cradle can alarm if connection between them is broken due to one of the devices going out of range.
 - If cradle is not powered, the scanner sounds the alarm. Includes USB suspend of the cradle.
 - Removing battery from the scanner will cause the cradle to sound the alarm.
- Causes for the alarm to not activate:
 - Scanner and cradle need to have an existing connection before alarm activates. No alarm on power up.
 - If the scanner is charging in or paired to another cradle/host by insertion or by scanning the pairing bar code, since it is presumed that in this case the scanner is not lost.
 - If another scanner connects to the cradle and causes the original scanner to disconnect.
 - If any of the batch modes are enabled or if auto-reconnect is NOT set to reconnect immediately.
 - Virtual Tether does not apply to the hosts that do not support auto-reconnect feature such as HID Bluetooth Low Energy (Discoverable) and SPP BT Classic (Discoverable).
 - Alarm is not activated if the disconnection occurs due to firmware update or configuration via 123Scan or SMS.
 - If scanner is connected to another cradle/host by insertion or by scanning the pairing bar code.
- Battery Preservation Mode:
 - If the scanner disconnects from the cradle due to the activation of the Battery Preservation Mode and the Virtual Tether Alarm on the cradle is enabled, only the LEDs on the cradle blink green and red.



NOTE Unintended consequences:

If Virtual Tether is enabled and a power outage occurs that causes multiple cradles or Bluetooth hosts to lose power, it activates alarms on the scanners paired to them. A trigger pull can be configured to defeat the alarm (see [Defeat Virtual Tether Alarm on page 5-62](#) for more details.) The alarms can also be defeated by either disconnecting the battery from the scanner or by pairing the scanner to another cradle or host that has power if one is available.

Bluetooth Radio, Linking, and Batch Operation

The DS3678 digital scanner has a Bluetooth Class 1 radio which achieves a range of at least 135m / 440ft (open air, line of sight). The actual range you achieve is influenced by the presence of other radios, shelving and wall materials as well as which cradle is tested. The environments vary widely and often influence radio ranges.

When the digital scanner goes out of communications range to the base, it can be configured for Batch Mode (see [AutoConfig \(Scanner Cloning Through Cradle\) on page 5-43](#)). The digital scanner has sufficient on board memory to store 500 barcodes of typical size (UPC/EAN).

Setting Up an iOS or Android Product To Work With The Digital Scanner

Perform the following steps on each device to establish a link.

HID Keyboard Emulation

1. On the DS3678, scan [Keyboard Emulation \(HID\) on page 5-6](#).
2. On an iOS/iPad/iPhone, select *Settings > General > Bluetooth* and turn Bluetooth *On*. Choose the DS3678 digital scanner from the list of discovered devices. A link should be established allowing scanning into any application with keyboard entry.
3. On an Android, select *Settings > Wireless & networks > Bluetooth* (to turn Bluetooth on, if not already on). Select *Bluetooth Settings* and choose the DS3678 digital scanner from the list of discovered devices. (The DS3678 digital scanner normally displays as DS3678 - xxxxxx, where xxxxxx is the serial number.)

CHAPTER 6 USER PREFERENCES & MISCELLANEOUS OPTIONS

Introduction

You can program the digital scanner to perform various functions, or activate different features. This chapter describes each user preference feature and provides programming barcodes for selecting these features.

The digital scanner ships with the settings shown in [Table 6-1 on page 6-2](#) (also see [Appendix A, Standard Default Parameters](#) for all defaults). If the default values suit requirements, programming is not necessary.

To set feature values, scan a single barcode or a short barcode sequence. The settings are stored in non-volatile memory and are preserved even when the digital scanner is powered down.

✓ **NOTE** Most computer monitors allow scanning the barcodes directly on the screen. When scanning from the screen, be sure to set the document magnification to a level where you can see the barcode clearly, and bars and/or spaces are not merging.

If not using a USB cable, select a host type (see each host chapter for specific host information) after the power-up beeps sound. This is only necessary upon the first power-up when connected to a new host.

To return all features to default values, see [Default Parameters on page 6-5](#). Throughout the programming barcode menus, asterisks indicate (*) default values.



* Indicates Default * High Volume _____ Feature/Option
(0) _____ Option Value

Scanning Sequence Examples

In most cases, scanning one barcode sets the parameter value. For example, to set the beeper tone to high, scan the **High Frequency** (beeper tone) barcode listed under [Beeper Tone on page 6-10](#). The digital scanner issues a fast warble beep and the LED turns green, signifying a successful parameter entry.

Other parameters require scanning several barcodes. See these parameter descriptions for this procedure.

Errors While Scanning

Unless otherwise specified, to correct an error during a scanning sequence, just re-scan the correct parameter.

User Preferences Parameter Defaults

[Table 6-1](#) lists defaults for user preferences parameters. To change the default values:

- Scan the appropriate barcodes in this guide. These new values replace the standard default values in memory. To recall the default parameter values, see [Default Parameters on page 6-5](#).
- Configure the digital scanner using the 123Scan² configuration program (see [Chapter 2, 123Scan and Software Tools](#)).

✓ **NOTE** See [Appendix A, Standard Default Parameters](#) for all user preferences, hosts, symbologies, and default parameters.

Table 6-1 User Preferences Parameter Defaults

Parameter	Parameter Number ¹	SSI Number ²	Default	Page Number
User Preferences				
Set Default Parameter			Restore Defaults	6-5
Parameter Bar Code Scanning	236	ECh	Enable	6-6
Beep After Good Decode	56	38h	Enable	6-6
Beep on <BEL>	150	96h	Enable	6-7
Direct Decode Indicator	859	F2h 5Bh	Disable	6-8
Beeper Volume	140	8Ch	High	6-9
Beeper Tone	145	91h	Medium	6-10
Beeper Duration	628	F1h 74h	Medium	6-11
Suppress Power Up Beeps	721	F1h D1h	Do Not Suppress	6-12
Decode Pager Motor	613	F1h 65h	Enable	6-13

**1. Parameter number decimal values are used for programming via RSM commands.
2. SSI number hex values are used for programming via SSI commands.**

Table 6-1 *User Preferences Parameter Defaults (Continued)*

Parameter	Parameter Number ¹	SSI Number ²	Default	Page Number
Decode Pager Motor Duration	626	F1h 72h	150 msec	6-13
Low Power Mode	128	80h	Enable (DS3678) Disable (DS3608)	6-15
Time Delay to Low Power Mode	146	92h	100 msec (DS3678) 1 Hour (DS3608)	6-16
Timeout to Low Power Mode from Auto Aim (DS3678 Only)	729		15 Seconds	6-19
DS3608-ER Power Mode	1777	F8h 06h F1h	Extended Range Full Power Mode	6-20
Battery Preservation Mode	1765	F8h 06h E5h	Enable	6-20
Hand-held Trigger Mode	138	8Ah	Level	6-22
Hands-free Mode	630	F1h 76h	Enable	6-23
Hand-held Decode Aiming Pattern	306	F0h 32h	Enable	6-24
Hands-free (Presentation) Decode Aiming Pattern	590	F1h 4Eh	Enable Hands-free (Presentation) Decode Aiming Pattern on PDF	6-25
Picklist Mode	402	F0h 92h	Disabled Always	6-26
Outdoor Picklist Mode	1880	N/A	Disable	6-27
FIPS Mode (DS3678 Only)	736	F1h E0h	Disable	6-28
Continuous Bar Code Read	649	F1h 89h	Disable	6-28
Unique Bar Code Reporting	723	F1h D3h	Enable	6-29
Decode Session Timeout	136	88h	9.9 Seconds	6-30
Hands-free Decode Session Timeout	400	F0h 90h	15	6-30
Timeout Between Decodes, Same Symbol	137	89h	0.5 Seconds	6-31
Timeout Between Decodes, Different Symbols	144	90h	0.1 Seconds	6-31
Triggered Timeout, Same Symbol	724	F1 D4	Disable	6-32
Mobile Phone/Display Mode	716	F1h CCh	Normal	6-33
PDF Prioritization	719	F1h CFh	Disable	6-34
PDF Prioritization Timeout	720	F1h D0h	200 msec	6-35

**1. Parameter number decimal values are used for programming via RSM commands.
2. SSI number hex values are used for programming via SSI commands.**

Table 6-1 User Preferences Parameter Defaults (Continued)

Parameter	Parameter Number ¹	SSI Number ²	Default	Page Number
Presentation Mode Field of View	609	F1h 61h	Full	6-36
Decoding Illumination	298	F0h 2Ah	Enable	6-37
Motion Tolerance (Hand-held Trigger Mode Only)	858	F2h 5Ah	Less Motion Tolerance	6-37
Ranging Light Immunity (DS36X8-ER only)	1722	F8h 06h BAh	60Hz Immunity	6-38
Battery Threshold		N/A		6-39
Battery Status High Threshold	1367		50%	
Battery Status Medium Threshold	1368		20%	
Battery Status Low Warning Threshold	1369		10%	
Battery Health Low Warning Threshold	1370		60%	
Add an Enter Key	N/A	N/A	N/A	6-41
Transmit Code ID Character	45	2Dh	None	6-42
Prefix Value	99, 105	63h, 69h	7013 <CR><LF>	6-43
Suffix 1 Value	98, 104	62h, 68h	7013 <CR><LF>	6-43
Suffix 2 Value	100, 106	64h, 6Ah		
Scan Data Transmission Format	235	EBh	Data as is	6-44
FN1 Substitution Values	103, 109	67h, 6Dh	7013 <CR><LF>	6-45
Transmit "No Read" Message	94	5Eh	Disable	6-46
Unsolicited Heartbeat Interval	1118	F8h 04h 5Eh	Disable	6-47
Product ID (PID) Type	1281	F8h 05h 01h	Host Type Unique	6-48
Product ID (PID) Value	1725	F8h 06h BDh	0	6-49
UID	740	F1h E4h	Disable	6-50
UID Error Mode Options	742	F1h E6h	UID Error Beep	6-52
DPM Mode (DS36X8-DP only)	1438	F8h 05h 9Eh	Enable DPM Mode 2	6-56
DPM Illumination Control (DS36X8-DP only)	429	F0h ADh	Cycle Illumination	6-57
DPM Rough Shiny Surface Decoding (DS36X8-DP only)	1904	N/A	Disable	6-58
Ultra High Density DPM Decoding (DS36X8-DP only)	1903	N/A	Disable	6-59

1. Parameter number decimal values are used for programming via RSM commands.
2. SSI number hex values are used for programming via SSI commands.

User Preferences

Default Parameters

The digital scanner can be reset to two types of defaults: factory defaults or custom defaults. Scan the appropriate barcode below to reset the digital scanner to its default settings and/or set the digital scanner's current settings as the custom default.

- **Restore Defaults** - Resets all default parameters as follows:
 - If custom default values were configured (see **Write to Custom Defaults**), the custom default values are set for all parameters each time the **Restore Defaults** barcode below is scanned.
 - If no custom default values were configured, the factory default values are set for all parameters each time the **Restore Defaults** barcode below is scanned. (For factory default values, see [Appendix A, Standard Default Parameters.](#))
- **Set Factory Defaults** - Scan the **Set Factory Defaults** barcode below to eliminate all custom default values and set the digital scanner to factory default values (For factory default values, see [Appendix A, Standard Default Parameters.](#))
- **Write to Custom Defaults** - Custom default parameters can be configured to set unique default values for all parameters. After changing all parameters to the desired default values, scan the **Write to Custom Defaults** barcode below to configure custom defaults.

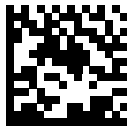

* Restore Defaults



Set Factory Defaults



Write to Custom Defaults

Parameter Bar Code Scanning

Parameter # 236 (SSI # ECh)

To disable the decoding of parameter barcodes, including the **Set Defaults** parameter barcodes, scan the **Disable Parameter Scanning** barcode below. To enable decoding of parameter barcodes, scan **Enable Parameter Scanning**.



* Enable Parameter Bar Code Scanning
(1)



Disable Parameter Bar Code Scanning
(0)

Beep After Good Decode

Parameter # 56 (SSI # 38h)

Scan a barcode below to select whether or not the digital scanner beeps after a good decode. If selecting **Do Not Beep After Good Decode**, the beeper still operates during parameter menu scanning and to indicate error conditions.

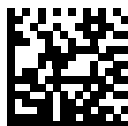

* Beep After Good Decode (Enable)
(1)



Do Not Beep After Good Decode (Disable)
(0)

Beep on <BEL>

Parameter # 150 (96h)

✓ **NOTE** This parameter only applies to the Bluetooth SPP (Serial Port Profile) and USB CDC Host. In Multipoint-to-Point mode only, the scanner that beeped last sounds Beep on <BEL>.

If you enable this parameter, the digital scanner issues a beep when it detects a <BEL> character. <BEL> indicates an illegal entry or other important event.



* Beep On <BEL> Character
(Enable)



Do Not Beep On <BEL> Character
(Disable)

Direct Decode Indicator

Parameter # 859 (SSI # F2h 5Bh)

This feature is only supported in Auto Aim and Standard (Level) trigger modes. Scan a barcode below to select optional blinking of the illumination on a successful decode:

- **Disable Direct Decode Indicator** - illumination does not blink on a successful decode.
- **1 Blink** - illumination blinks once upon a successful decode.
- **2 Blinks** - illumination blinks twice upon a successful decode.



* **Disable Direct Decode Indicator**
(0)



1 Blink
(1)



2 Blinks
(2)

Beeper Volume

Parameter # 140 (SSI # 8Ch)

To select a beeper volume, scan the **Low Volume**, **Medium Volume**, or **High Volume** barcode.



Low Volume
(2)



Medium Volume
(1)



*** High Volume**
(0)

Beeper Tone

Parameter # 145 (SSI # 91h)

To select a beeper tone, scan one of the following barcodes.



Off
(3)



Low Tone
(2)



* Medium Tone
(1)



High Tone
(0)

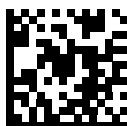

Medium to High Tone (2-tone)
(4)

Beeper Duration

Parameter # 628 (SSI # F1h 74h)

To select the duration for the beeper, scan one of the following barcodes.



Short
(0)



*** Medium**
(1)



Long
(2)

Suppress Power Up Beeps

Parameter # 721 (SSI # F1h D1h)

Scan a barcode below to select whether or not to suppress the digital scanner's power-up beeps.

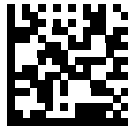

*** Do Not Suppress Power Up Beeps
(0)**



**Suppress Power Up Beeps
(1)**

Decode Pager Motor

Parameter # 613 (SSI # F1h 65h)

The scanner includes a pager motor which, when enabled, vibrates the scanner for a period of time when a successful decode occurs.

✓ **NOTE** When the pager motor is enabled and the DS3608 scanner is in the Intellistand, the pager motor disables until the scanner is removed from the Intellistand.

Scan a barcode below to enable or disable the pager motor. If enabled, scan the appropriate barcode to set the period of time in which to vibrate the scanner (see [Decode Pager Motor Duration](#) below).

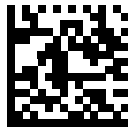

Pager Motor Disable
(0)



* Pager Motor Enable
(1)

Decode Pager Motor Duration

Parameter # 626 (SSI # F1h 72h)



* 150 msec
(15)



200 msec
(20)

Decode Pager Motor Duration (continued)



250 msec
(25)



300 msec
(30)

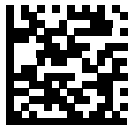

400 msec
(40)



500 msec
(50)

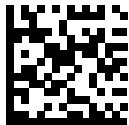

600 msec
(60)



750 msec
(75)

Low Power Mode

Parameter # 128 (SSI # 80h)

✓ **NOTE** The Low Power Mode parameter only applies for non-USB and non-RS485 host interfaces, and when [Hand-held Trigger Mode on page 6-22](#) is set to Level (Standard).

This parameter determines whether or not the digital scanner enters low power mode after a decode attempt. If disabled, power remains on after each decode attempt. The DS3608 corded scanner default is Disable. The DS3678 cordless scanner default is Enable.



Disable Low Power Mode
(0)



Enable Low Power Mode
(1)

Time Delay to Low Power Mode

Parameter # 146 (SSI # 92h)

✓ **NOTE** This parameter only applies when *Low Power Mode* is enabled.

This parameter sets the time it takes the scanner to enter Low Power Mode after any scanning activity. Scan the appropriate barcode below to set the time. The DS3608 corded scanner default is 1 Hour. The DS3678 cordless scanner default is 100 msec.



100 msec
(65)



500 msec
(69)

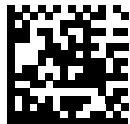

1 Second
(17)



2 sec
(18)



3 sec
(19)

Time Delay to Low Power Mode (continued)



4 Seconds
(20)



5 Seconds
(21)



10 Seconds
(26)

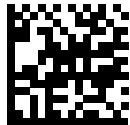

1 Minute
(33)



5 Minutes
(37)



15 Minutes
(43)

Time Delay to Low Power Mode (continued)



**30 Minutes
(45)**



**45 Minutes
(46)**



**1 Hour
(49)**



**3 Hours
(51)**



**6 Hours
(54)**

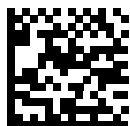

**9 Hours
(57)**

Timeout to Low Power Mode from Auto Aim

Parameter # 729

✓ **NOTE** Timeout to Low Power Mode from Auto Aim applies to the DS3678 cordless scanner only.

If you select **Disabled**, the scanner does not enter Low Power Mode when in Auto Aim.

This parameter sets the time the scanner remains in auto aim before entering Low Power Mode.

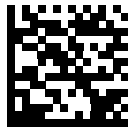

Disabled
(0)



5 Seconds
(5)



*** 15 Seconds**
(11)



30 Seconds
(13)

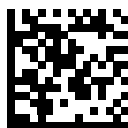

1 Minute
(17)

DS3608-ER Power Mode

Parameter # 1777 (SSI # F8h 06h F1h)

This parameter determines whether the DS3608 extended range digital scanner enters full power mode or 500mA compatibility mode. When selecting the 500mA compatibility mode parameter, you may experience decreased decode performance when scanning in low light or dark environments at an extended range.



* Extended Range Full Power Mode
(0)



Extended Range 500mA Compatibility Mode
(1)

Battery Preservation Mode

Parameter # 1765 (SSI # F8h 06h E5h)

Battery Preservation Mode preserves the battery charge when the digital scanner is not being used for an extended period of time.

- Scan **Enable Battery Preservation Mode** to internally disconnect the battery from the digital scanner when the digital scanner is unused and not being charged for nine hours¹. In this mode the scanner completely turns off. This preserves the battery charge as there is no current drain on the battery and significantly extends battery shelf life. To exit Battery Preservation Mode² and return to normal operation either press the digital scanner trigger or return to charging. The digital scanner cannot scan until the wake up process is complete³. This takes a few seconds. The amount of time before the battery disconnects from the scanner can be set via Battery Preservation Timeout Value below.

✓ **NOTE** 1 Nine hours is the default timeout value but can be changed via Battery Preservation Timeout Value.

2 [Low Power Mode on page 6-15](#) must be enabled for Battery Preservation Mode to take effect.

3 When asleep in Battery Preservation Mode, the digital scanner cannot be accessed for remote management.

- Scan **Disable Battery Preservation Mode** to keep the battery connected to the digital scanner at all times. This prevents the battery from being disconnected from the scanner after hours of sitting idle (no scanning) and not charging. When Battery Preservation Mode is disabled, substantial battery shelf life improvements are not gained as compared to when Battery Preservation Mode is enabled.

- Scan **Battery Preservation Timeout** followed by 3 digits in [Appendix H, Numeric Bar Codes](#) to select a different battery preservation timeout value (the default for battery preservation timeout is nine hours). For example, if the preservation timeout value should be 12 hours, scan Battery Preservation Timeout below, then scan 0, 1, and 2 in [Appendix H, Numeric Bar Codes](#). To correct an error or change the selection, scan [Cancel on page H-2](#).



***Enable Battery Preservation Mode
(9)**



**Disable Battery Preservation Mode
(0)**



Battery Preservation Timeout Value

Hand-held Trigger Mode

Parameter # 138 (SSI # 8Ah)

Select one of the following trigger modes for the digital scanner.

- **Standard (Level)** - A trigger pull activates decode processing. Decode processing continues until the barcode decodes, you release the trigger, or the [Decode Session Timeout on page 6-30](#) occurs.
- **Presentation (Blink)** - The digital scanner activates decode processing when it detects a barcode in its field of view. After a period of non-use, the digital scanner enters a low power mode, in which the LEDs turn off until the digital scanner senses motion.

✓ **NOTE** The DS36X8-ER and DS36X8-XR only use Near Focus in Presentation (Blink) mode.

✓ **NOTE** The DS36X8-HP, HD, and DP scanner uses an internal dim illumination state when it enters low power mode until motion is detected.

- **Auto Aim** - This trigger mode projects the aiming dot when you lift the digital scanner. A trigger pull activates decode processing. After 5 seconds of inactivity the aiming dot shuts off.
- **Two Stage Option 1** - Upon trigger pull, the aimer appears. When the trigger is released, the scanner activates decode processing, using the currently configured decode session timeout. If the trigger is pulled again while in a decode session, the session is terminated and the aimer appears.
- **Two Stage Option 2** - Upon trigger pull, the aimer appears. When the trigger is released, the aimer turns off. Pulling the trigger twice quickly activates decode processing, until the trigger is released.



* Level (Standard)
(0)



Presentation (Blink)
(7)

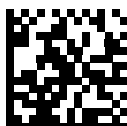

Auto Aim
(9)

Hand-held Trigger Mode (continued)



Two Stage Option 1
(14)



Two Stage Option 2
(15)

Hands-free Mode

Parameter # 630 (SSI # F1h 76h)

If you select **Disable Hands-free Mode**, the digital scanner behaves according to the setting of the [Hand-held Trigger Mode on page 6-22](#).



* Enable Hands-free Mode
(1)



Disable Hands-free Mode
(0)

Hand-held Decode Aiming Pattern

Parameter # 306 (SSI # F0h 32h)

Select **Enable Hand-held Decode Aiming Pattern** to project the aiming dot during barcode capture, **Disable Hand-held Decode Aiming Pattern** to turn the aiming dot off, or **Enable Hand-held Decode Aiming Pattern on PDF** to project the aiming dot when the digital scanner detects a 2D barcode.

- ✓ **NOTE** It is not recommended to disable **Hand-held Decode Aiming Pattern** when decoding a far barcode with the DS36X8-ER or DS36X8-XR.
- ✓ **NOTE** With [Picklist Mode on page 6-26](#) enabled, the decode aiming dot flashes even when the **Hand-held Decode Aiming Pattern** is disabled.



* **Enable Hand-held Decode Aiming Pattern**
(2)



Disable Hand-held Decode Aiming Pattern
(0)



Enable Hand-held Decode Aiming Pattern on PDF
(3)

Hands-free Decode Aiming Pattern

Parameter # 590 (SSI # F1h 4Eh)

Select **Enable Hands-free Decode Aiming Pattern** to project the aiming dot during barcode capture, **Disable Hands-free Decode Aiming Pattern** to turn the aiming dot off, or **Enable Hands-free Decode Aiming Pattern on PDF** to project the aiming dot when the digital scanner detects a 2D barcode.



NOTE With [Picklist Mode on page 6-26](#) enabled, the decode aiming dot flashes even when the **Decode Aiming Pattern** is disabled.



Enable Hands-free Decode Aiming Pattern
(1)



Disable Hands-free Decode Aiming Pattern
(0)



*** Enable Hands-free Decode Aiming Pattern on PDF**
(2)

Picklist Mode

Parameter # 402 (SSI # F0h 92h)

Picklist mode enables the digital scanner to decode only barcodes that are aligned under the LED aiming dot. Select one of the following picklist modes for the digital scanner:

- **Disabled Always** - Picklist mode is always disabled.
- **Enabled in Hand-held Mode** - Picklist mode is enabled in Hand-held mode.
- **Enable Always** - Picklist mode is always enabled.
- **Enabled in Hands-free Mode** - Picklist mode is enabled in Hands-free mode.

✓ **NOTE** **Picklist Mode** temporarily overrides the **Disable Decode Aiming Pattern** parameter. You can not disable the Decode Aiming Pattern when Picklist Mode is enabled.

✓ **NOTE** For the DS36X8-DP, **Picklist Mode** is automatically disabled when **DPM Mode** is enabled.



* Disabled Always
(0)



Enabled in Hand-held Mode
(1)



Enabled Always
(2)



Enabled in Hands-free Mode
(3)

Outdoor Picklist Mode

Parameter #1880

Enable this feature for improved picklist performance in direct sunlight.



Enable Outdoor Picklist
(1)

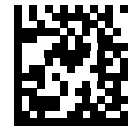

*** Disable Outdoor Picklist**
(0)

FIPS Mode

Parameter # 736 (F1h E0h)

✓ **NOTE** FIPS Mode applies to the DS3678 cordless scanner only.

The Federal Information Processing Standard (FIPS) 140-3 is a U.S. government computer security standard used to accredit cryptographic modules. FIPS enabled DS3678 scanners and cradles offer this secure mode of operation.

To enable the FIPS mode of operation (disabled by default), scan the **Enable FIPS** barcode. The scanner attempts to establish a secure session with the cradle to which it is connected. On success, the scanner lights an amber LED on every trigger pull to signal that all data will be transmitted over Bluetooth in a secure fashion. On failure, the scanner will sound transmission failure error message on every attempt to transmit data.

To disable the FIPS mode, scan the **Disable FIPS** barcode at any time.



Enable FIPS
(1)



* Disable FIPS
(0)

Continuous Bar Code Read

Parameter # 649 (SSI # F1h 89h)

Enable this to report every barcode while the trigger is pulled.

✓ **NOTE** Zebra strongly recommends enabling [Picklist Mode on page 6-26](#) with this feature. Disabling *Picklist Mode* can cause accidental decodes when more than one barcode is in the digital scanner's field of view.



* **Disable Continuous Bar Code Read**
(0)



Enable Continuous Bar Code Read
(1)

Unique Bar Code Reporting

Parameter # 723 (SSI # F1h D3h)

Enable this to report only unique barcodes while the trigger is pulled. This option only applies when **Continuous Bar Code Read** is enabled.



Disable Continuous Bar Code Read Uniqueness
(0)



* **Enable Continuous Bar Code Read Uniqueness**
(1)

Decode Session Timeout

Parameter # 136 (SSI # 88h)

This parameter sets the maximum time decode processing continues during a scan attempt. It is programmable in 0.1 second increments from 0.5 to 9.9 seconds. The default timeout is 9.9 seconds.

To set a Decode Session Timeout, scan the barcode below. Next, scan two numeric barcodes from [Appendix H, Numeric Bar Codes](#) that correspond to the desired on time. Enter a leading zero for single digit numbers. For example, to set a Decode Session Timeout of 0.5 seconds, scan the barcode below, then scan the **0** and **5** barcodes. To correct an error or change the selection, scan [Cancel on page H-2](#).

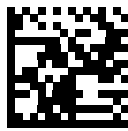

Decode Session Timeout

Hands-free Decode Session Timeout

Parameter # 400 (SSI # F0h 90h)

This parameter is the Hands-free compliment to the **Decode Session Timeout**. It configures the minimum and maximum decode processing time during a Hands-free scan attempt. It only applies to the Hands-free trigger mode.

The minimum decode processing time is defined as the time in which the scanner stops decoding when an object is removed or left stationary in the imaging field of view.

The maximum decode processing time is defined as the time in which the scanner stops decoding when an object is left in and is moving in the field of view.

Both the maximum and minimum times are configured using a single setting. The relationship of this setting is as follows:

Setting Value	Minimum Time	Maximum Time
$X < 25$	250 msec	$X * 100$ msec
$X \geq 25$	$X * 10$ msec	$X * 100$ msec

For example, a setting value of 100 results in the scanner turning off approximately 1 second after an object is removed from the field of view or 10 seconds while an object is in the field of view moving.

The default value of the setting is 15 which results in a minimum time of 250 msec and maximum time of 1.5 seconds.

Adjust this setting based on your requirements. For example, when doing prioritization, this parameter should be set to a value where the maximum time is above the PDF prioritization timeout.

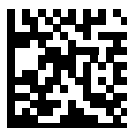

Hands-free Decode Session Timeout

Timeout Between Decodes, Same Symbol

Parameter # 137 (SSI # 89h)

Use this option in Continuous Bar Code Read mode to prevent the beeper from continuously beeping when a symbol is left in the digital scanner's field of view. The barcode must be out of the field of view for the timeout period before the digital scanner reads the same consecutive symbol. It is programmable in 0.1 second increments from 0.0 to 9.9 seconds. The default interval is 0.5 seconds.

To select the timeout between decodes for the same symbol, scan the barcode below, then scan two numeric barcodes from [Appendix H, Numeric Bar Codes](#) that correspond to the desired interval, in 0.1 second increments.

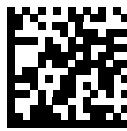

Timeout Between Decodes, Same Symbol

Timeout Between Decodes, Different Symbols

Parameter # 144 (SSI # 90h)

Use this option in presentation mode or Continuous Bar Code Read to control the time the digital scanner is inactive between decoding different symbols. It is programmable in 0.1 second increments from 0.1 to 9.9 seconds. The default is 0.1 seconds.

To select the timeout between decodes for different symbols, scan the barcode below, then scan two numeric barcodes from [Appendix H, Numeric Bar Codes](#) that correspond to the desired interval, in 0.1 second increments.



NOTE Timeout Between Decodes, Different Symbols cannot be greater than or equal to the **Decode Session Timeout**.

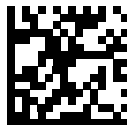

Timeout Between Decodes, Different Symbols

Triggered Timeout, Same Symbol

Parameter # 724 (SSI # F1 D4)

Scan **Enable Triggered Timeout, Same Symbol** below to apply **Timeout Between Decodes, Same Symbol** (parameter #137 on page [6-31](#)) in hand-held trigger mode.

When enabled, subsequent scans of the same barcode are ignored until **Timeout Between Decodes, Same Symbol** expires.



NOTE 1. This feature does not apply to **Timeout Between Decodes, Different Symbols**.

2. **Timeout Between Decodes, Same Symbol** must be less than the **Time Delay to Low Power Mode** (parameter #146 on page [6-16](#))



Enable Triggered Timeout, Same Symbol



*** Disable Triggered Timeout, Same Symbol**

Mobile Phone/Display Mode

Parameter # 716 (SSI # F1h CCh)

This mode improves barcode reading performance off mobile phones and electronic displays. Select Enhanced in Hand-held, Hands-free, or both modes, or select Normal Mobile Phone/Display Mode.

- ✓ **NOTE** The DS36X8-ER restricts **Mobile Phone/Display Mode** to Near Focus only.
- ✓ **NOTE** The DS36X8-DP restricts **Mobile Phone/Display Mode**. Disable [DPM Mode on page 6-56](#) for the Mobile Phone/Display Mode to function properly.



* Normal Mobile Phone/Display Mode
(0)



Enhanced in Hand-held Mode
(1)



Enhanced in Hands-free Mode
(2)



Enhanced in Both Modes
(3)

PDF Prioritization

Parameter # 719 (SSI # F1h CFh)

Enable this feature to delay decoding a 1D barcode (Code 128) by the value specified in [PDF Prioritization Timeout](#). During that time the digital scanner attempts to decode a PDF417 symbol (e.g., on a US driver's license), and if successful, reports this only. If it does not decode (can not find) a PDF417 symbol, it reports the 1D symbol after the timeout. The 1D symbol must be in the device's field of view for the digital scanner to report it. This parameter does not affect decoding other symbologies.



NOTE

The 1D Code 128 barcode lengths include the following:

- 7 to 10 characters
- 14 to 22 characters
- 27 to 28 characters

In addition, a Code 39 barcode with the following lengths are considered to potentially be part of a US driver's license:

- 8 characters
- 12 characters



* Disable PDF Prioritization
(0)



Enable PDF Prioritization
(1)

PDF Prioritization Timeout

Parameter # 720 (SSI # F1h D0h)



NOTE The [Hands-free Decode Session Timeout on page 6-30](#) should be set to a longer duration than **PDF Prioritization Timeout** when configured.

When [PDF Prioritization on page 6-34](#) is enabled, this timeout specifies how long the digital scanner attempts to decode a PDF417 symbol before reporting the 1D barcode in the field of view.

Scan the following barcode, then scan four digits from [Appendix H, Numeric Bar Codes](#) that specify the timeout in milliseconds. For example, to enter 400 msec, scan the following barcode, then scan 0400. The range is 0 to 5000 msec, and the default is 200 msec.



PDF Prioritization Timeout

Presentation Mode Field of View

Parameter # 609 (SSI # F1h 61h)



NOTE Presentation Mode Field of View does not apply to the DS36X8-DP or DS-36X8-DPA.

In presentation mode, by default the digital scanner searches the larger area of the aiming pattern (**Full Field of View**).

To search for a barcode in a smaller region around the aiming dot's center in order to speed search time, select **Small Field of View** or **Medium Field of View**.



Small Field of View
(0)



Medium Field of View
(1)



*** Full Field of View**
(2)

Decoding Illumination

Parameter # 298 (SSI # F0h 2Ah)

Selecting **Enable Decoding Illumination** causes the digital scanner to flash illumination to aid decoding. Select **Disable Decoding Illumination** to prevent the digital scanner from using decoding illumination.

Enabling illumination usually results in superior images. The effectiveness of the illumination decreases as the distance to the target increases.



* **Enable Decoding Illumination**
(1)



Disable Decoding Illumination
(0)

Motion Tolerance (Hand-held Trigger Modes Only)

Parameter # 858 (SSI # F2h 5Ah)

Less Motion Tolerance provides optimal decoding performance on 1D barcodes.

To increase motion tolerance and speed decoding when scanning a series of 1D barcodes in rapid progression, scan **More Motion Tolerance**.



* **Less Motion Tolerance**
(0)



More Motion Tolerance
(1)

Ranging Light Immunity

Parameter # 1722 (SSI # F8h 06h BAh)

This parameter sets the light immunity optimization for ER ranging.

✓ **NOTE** Light Immunity applies to the DS36X8-ER only.



* 60Hz Immunity
(0)

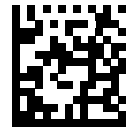

50Hz Immunity
(1)

Battery Threshold

Scan the appropriate barcode below to select the desired battery status threshold.

✓ **NOTE** The Battery Threshold parameters do not apply to DS3678-HP with Keypad & Display.

- **Battery Status High Threshold - Parameter #1367**

This parameter sets the threshold used to show the Battery Status is High. When the battery status is above the High Threshold, the battery indicator is green.

Scan this barcode followed by 2 digits from [Appendix H, Numeric Bar Codes](#) that correspond to the desired percentage from 00 to 99. The default is 50%.

- **Battery Status Medium Threshold - Parameter #1368**

This parameter sets the threshold used to show the Battery Status is Medium. When the battery status is above the Medium Threshold (and below the High Threshold), the Battery indicator is amber. When the battery status is below the Medium Threshold, the Battery indicator is red.

Scan this barcode followed by 2 digits from [Appendix H, Numeric Bar Codes](#) that correspond to the desired percentage from 00 to 99. The default is 20%.

- **Battery Status Low Warning Threshold - Parameter #1369**

This parameter sets the threshold to indicate Battery Status is Critically Low. When the battery status is below the Low Warning Threshold, on every trigger release the scanner issues 4 short beeps.

Scan this barcode followed by 2 digits from [Appendix H, Numeric Bar Codes](#) that correspond to the desired percentage from 00 to 99. The default is 10%.

- **Battery Health Low Warning Threshold - Parameter #1370**

This parameter sets the threshold to indicate Battery Health is Low. When the battery health is below the Low Health Threshold, all battery indication will alternate between Red and the appropriate Battery Status indication.

Scan this barcode followed by 2 digits from [Appendix H, Numeric Bar Codes](#) that correspond to the desired percentage from 00 to 99. The default is 60%.

✓ **NOTE** When Battery Health is Low, you should consider replacing the battery.



Battery Status High Threshold

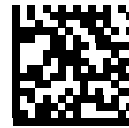

Battery Status Medium Threshold

Battery Threshold (continued)



Battery Status Low Warning Threshold



Battery Health Low Warning Threshold

Add an Enter Key

To add an Enter key (carriage return/line feed) after scanned data, scan the following barcode.
To program other prefixes and/or suffixes, see [Prefix/Suffix Values on page 6-43](#).

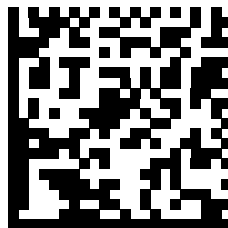

Add Enter Key (Carriage Return/Line Feed)

Transmit Code ID Character

Parameter # 45 (SSI # 2Dh)

A Code ID character identifies the code type of a scanned barcode. This is useful when decoding more than one code type. In addition to any single character prefix already selected, the Code ID character is inserted between the prefix and the decoded symbol.

Select no Code ID character, a Symbol Code ID character, or an AIM Code ID character. For Code ID characters, see [Programming Reference on page E-1](#).

✓ **NOTE** If you enable Symbol Code ID Character or AIM Code ID Character, and enable [Transmit "No Read" Message on page 6-46](#), the digital scanner appends the code ID for Code 39 to the NR message.

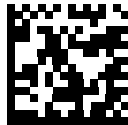

Symbol Code ID Character
(2)



AIM Code ID Character
(1)



* None
(0)

Prefix/Suffix Values

Key Category Parameter # P = 99, S1 = 98, S2 = 100 (SSI # P = 63h, S1 = 62h, S2 = 64h)

Decimal Value Parameter # P = 105, S1 = 104, S2 = 106 (SSI # P = 69h, S1 = 68h, S2 = 6Ah)

You can append a prefix and/or one or two suffixes to scan data for use in data editing. To set a value for a prefix or suffix, scan a four-digit number (i.e., four barcodes from [Appendix H, Numeric Bar Codes](#)) that corresponds to that value. See [Appendix I, ASCII Character Sets](#) for the four-digit codes.

When using host commands to set the prefix or suffix, set the key category parameter to 1, then set the 3-digit decimal value. See [Appendix I, ASCII Character Sets](#) for the four-digit codes.

The default prefix and suffix value is 7013 <CR><LF> (the Enter key). To correct an error or change a selection, scan [Cancel on page H-2](#).

✓ **NOTE** To use Prefix/Suffix values, first set the [Scan Data Transmission Format on page 6-44](#).



Scan Prefix
(7)



Scan Suffix 1
(6)

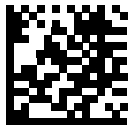

Scan Suffix 2
(8)



Data Format Cancel

Scan Data Transmission Format

Parameter # 235 (SSI # EBh)

To change the scan data format, scan one of the following eight barcodes corresponding to the desired format.

✓ **NOTE** If using this parameter do not use ADF rules to set the prefix/suffix.

To set values for the prefix and/or suffix, see [Prefix/Suffix Values on page 6-43](#).



* Data As Is
(0)



<DATA> <SUFFIX 1>
(1)



<DATA> <SUFFIX 2>
(2)



<DATA> <SUFFIX 1> <SUFFIX 2>
(3)

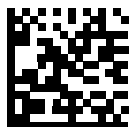

<PREFIX> <DATA >
(4)

Scan Data Transmission Format (continued)

<PREFIX> <DATA> <SUFFIX 1>
(5)



<PREFIX> <DATA> <SUFFIX 2>
(6)



<PREFIX> <DATA> <SUFFIX 1> <SUFFIX 2>
(7)

FN1 Substitution Values**Key Category Parameter # 103 (SSI # 67h)****Decimal Value Parameter # 109 (SSI # 6Dh)**

The wedge and USB HID keyboard hosts support a FN1 Substitution feature. Enabling this substitutes any FN1 character (0x1b) in an EAN128 barcode with a value. This value defaults to 7013 (Enter Key).

When using host commands to set the FN1 substitution value, set the key category parameter to 1, then set the 3-digit keystroke value. See the ASCII Character Set table for the current host interface for the desired value.

To select a FN1 substitution value via barcode menus:

1. Scan the barcode below.

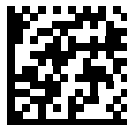

Set FN1 Substitution Value

2. Locate the keystroke desired for FN1 Substitution in the ASCII Character Set table for the current host interface. Enter the 4-digit ASCII Value by scanning each digit in [Appendix H, Numeric Bar Codes](#).

To correct an error or change the selection, scan **Cancel**.

To enable FN1 substitution for USB HID keyboard, scan the **Enable FN1 Substitution** barcode on page [6-45](#).

Transmit “No Read” Message

Parameter # 94 (SSI # 5Eh)

Scan a barcode below to select whether or not to transmit a No Read message. Enable this to transmit the characters NR when a successful decode does not occur before trigger release or the **Decode Session Timeout** expires. See [Decode Session Timeout on page 6-30](#). Disable this to send nothing to the host if a symbol does not decode.



NOTE If you enable **Transmit No Read**, and also enable Symbol Code ID Character or AIM Code ID Character for [Transmit Code ID Character on page 6-42](#), the digital scanner appends the code ID for Code 39 to the NR message.



**Enable No Read
(1)**



*** Disable No Read
(0)**

Unsolicited Heartbeat Interval

Parameter # 1118 (SSI # F8h 04h 5Eh)

The digital scanner supports sending *Unsolicited Heartbeat Messages* to assist in diagnostics. To enable this feature and set the desired unsolicited heartbeat interval, scan one of the time interval barcodes below, or scan **Set Another Interval** followed by four numeric barcodes from [Appendix H, Numeric Bar Codes](#) (scan sequential numbers that correspond to the desired number of seconds). The range is 0 - 9999.

Scan **Disable Unsolicited Heartbeat Interval** to turn off the feature.

The heartbeat event is sent as decode data (with no decode beep) in the form of:

MOTEVTHB:nnn

where *nnn* is a three-digit sequence number starting at 001 and wrapping after 100.



10 Seconds
(10)



1 Minute
(60)



Set Another Interval



*** Disable Unsolicited Heartbeat Interval**
(0)

Product ID (PID) Type

Parameter # 1281 (SSI # F8h 05h 01h)

Scan one of the following barcodes to define the PID value reported in USB enumeration.

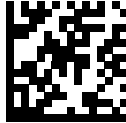

***Host Type Unique
(0)**

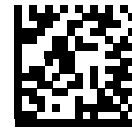

**Product Unique
(1)**



**IBM Unique
(2)**

Product ID (PID) Value

Parameter # 1725 (SSI # F8h 06h BDh)

To set a Product ID value, scan **Set PID Value**, and then scan four numeric barcodes in [Appendix H, Numeric Bar Codes](#) that correspond to the value. Enter a leading zero for single digit numbers. To correct an error, or change a selection, scan [Cancel on page H-2](#). The range is (0,1600-1649).



NOTE This parameter applies to customers using a Firmware Flash Update per the Toshiba Global Commerce Solutions (TGCS) Universal Serial Bus OEM Point-of-Sale Device Interface.



Set PID Value

UID Parsing

Parameter # 740 (SSI # F1h E4h)

✓ **NOTE** UID constructs are compliant with the US Department of Defense MIL-STD-130N w/Change 1.

A UID, or Unique Identifier, is used to identify and track data (e.g., manufacturer, distribution, lifetime of products and other information) specified by the United States Department of Defense for all imported packages containing merchandise equal to or greater than \$5,000.00. Vendors are required to provide a legible and permanent UID marking, in the form of a data matrix barcode, with the contents.

DP configurations of the digital scanner read the data matrix barcode, verify it is a valid UID barcode and parse the data into a UID barcode (**Criterion: Parsed UID** barcode type with UID fields). This output can be used at a later date.

To enable/disable UID parsing, scan the appropriate barcode below. UID parsing is disabled by default. Scan **Enable Embedded UID Parsing** to start the parsing process.



* Disable UID Parsing
(0)



Enable Embedded UID Parsing
(1)

UID Parsing Output

When a UID successfully parses the fields shown in [Table 6-2](#) are created. Each field is separated by a comma. If data is missing from a field in the UID, a lone comma fills the field.

- ✓ **NOTE** When a UID successfully parses, a parsed UID barcode type transmits to the host.
When parsing is unsuccessful but data transmits to the host anyway, the data is in the data matrix format.

Table 6-2 *Output Fields*

Jrj qj	Hj xhvæyrt s
1	Concatenated UID
2	Construct type (UID1 or UID2)
3	Enterprise ID
4	Serialized part #
5	Original part #
6	Lot #
7	Current part #
8	Scanned data in ASCII mode

Example Output - Successful Parsed Data

D12345WS51-004041,UID2,12345,041,WS51-004,,,[> rs 06 gs 17V12345 gs 1PWS51-004 gs S041 rs eot

Table 6-3 *Output Fields*

Jrj qj	Hj xhvæyrt s
1	D12345WS51-004041
2	UID2
3	12345
4	041
5	WS51-004
6	(no data supplied, comma filled field)
7	(no data supplied, comma filled field)
8	[> rs 06 gs 17V12345 gs 1PWS51-004 gs S041 rs eot

UID Error Mode Options

Parameter # 742 (SSI # F1h E6h)

- **UID Error Beep** (default): Scan **UID Error Beep** to program the digital scanner not to parse the data contained in the UID when the UID is not formatted correctly. An error tone sounds and no data transmits to the host.
- **UID Error Pass Data**: Scan **UID Error Pass Data** to program the digital scanner to transmit data to the host even when parsing fails. The digital scanner reads the incorrectly encoded UID, assumes the host can process the data and transmits the unformatted contents of the barcode. No error tone sounds.
- **UID Error Beep and Pass Data**: Scan **UID Error Beep and Pass Data** to program the digital scanner to transmit data to the host even when parsing fails. The digital scanner reads the incorrectly encoded UID, assumes the host can process the data and transmits the unformatted contents of the barcode. An error tone sounds.

Scan the appropriate barcode below to program potential error conditions.



* UID Error Beep
(0)



UID Error Pass Data
(1)



UID Error Beep and Pass Data
(2)

Sample ADF Rule for UID

To transmit only the concatenated UID field of the parsed UID, scan the barcodes below, in order.



Begin New Rule



Criterion: Parsed UID



Send Data Up to Character



'
(Comma)

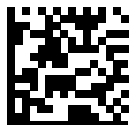

Save Rule



Send Enter Key

UID Sample Bar Codes

05 Format



WS51-004041,UID2,,041,WS51-004,,[]> rs 05 gs 01WS51-004 gs 21041 rs eot

Table 6-4 Sample 05 Formatted Data

Jrj qj	Hj xhvuyt s
1 - Concatenated UID	WS51-004041
2 - Construct type (UID1 or UID2)	UID2
3 - Enterprise ID	, (no data supplied)
4 - Serialized part #	041
5 - Original part #	WS51-004
6 - Lot #	, (no data supplied)
7 - Current part #	, (no data supplied)
8 - Scanned data in ASCII mode	[]> rs 05 gs 01WS51-004 gs 21041 rs eot

06 Format



D12345WS51-004041,UID2,12345,041,WS51-004,,[]> rs 06 gs 17V12345 gs 1PWS51-004 gs S041 rs eot

Table 6-5 Sample 06 Formatted Data

Jrj qj	Hj xhvuyt s
1 - Concatenated UID	D12345WS51-004041
2 - Construct type (UID1 or UID2)	UID2
3 - Enterprise ID	12345
4 - Serialized part #	041
5 - Original part #	WS51-004
6 - Lot #	, (no data supplied)
7 - Current part #	, (no data supplied)
8 - Scanned data in ASCII mode	[]> rs 06 gs 17V12345 gs 1PWS51-004 gs S041 rs eot

12 Format

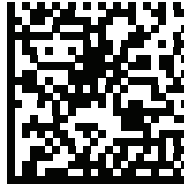

D12345WS51-004041,UID2,12345,041,WS51-004,,[> rs 12 gs MFR 12345 gs PNO WS51-004 gs SEQ 041 rs eot

Table 6-6 Sample 12 Formatted Data

Jrj qj	Hj xhvuyt s
1 - Concatenated UID	D12345WS51-004041
2 - Construct type (UID1 or UID2)	UID2
3 - Enterprise ID	12345
4 - Serialized part #	041
5 - Original part #	WS51-004
6 - Lot #	, (no data supplied)
7 - Current part #	, (no data supplied)
8 - Scanned data in ASCII mode	[> rs 12 gs MFR 12345 gs PNO WS51-004 gs SEQ 041 rs eot

DD Format

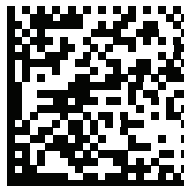

D12345WS51-004041,UID2,12345,041,WS51-004,,[> rs DD gs MFR 12345 gs PNO WS51-004 gs SEQ 041 rs eot

Table 6-7 Sample DD Formatted Data

Jrj qj	Hj xhvuyt s
1 - Concatenated UID	D12345WS51-004041
2 - Construct type (UID1 or UID2)	UID2
3 - Enterprise ID	12345
4 - Serialized part #	041
5 - Original part #	WS51-004
6 - Lot #	, (no data supplied)
7 - Current part #	, (no data supplied)
8 - Scanned data in ASCII mode	[> rs DD gs MFR 12345 gs PNO WS51-004 gs SEQ 041 rs eot

DPM Mode

Parameter # 1438 (SSI # F8h 05h 9Eh)



NOTE This parameter applies to the DS36X8-DP only.



NOTE If you enable **DPM Mode**, the decoder behaves as if the **Data Matrix Inverse Autodetect** setting is selected.

Unlike barcodes typically printed on labels, a direct part mark (DPM) is a symbol that is marked directly on an item's surface for permanent identification, using methods such as laser etching, dot peening, or direct-printing.

Select one of the following DPM modes based on the type of barcode being scanned. There are two DPM modes which are recommended for different sets of barcode characteristics. The combinations of these characteristics vary and it is recommended that all modes are tested on the target barcode to determine the best mode for the application.

- **Disable DPM Mode** - No special processing occurs.
- **DPM Mode 1** - Optimizes decoding performance on smaller DPM barcodes, typically found on electronics and medical instruments, especially on smooth surfaces. These barcodes tend to be laser etched or direct-printed.
- **DPM Mode 2** - Optimizes decoding performance on larger DPM barcodes, typically found on industrial parts, especially on rough, grainy, or visibly machined surfaces. These barcodes tend to be dot-peened or laser etched.



**Disable DPM Mode
(0)**



**Enable DPM Mode 1
(1)**



*** Enable DPM Mode 2
(2)**

DPM Illumination Control

Parameter # 429 (SSI # F0h ADh)

- ✓ **NOTE** This parameter applies to the DS36X8-DP only.
- ✓ **NOTE** In Presentation Mode, the DS36X8-DP scanner uses the internal dim illumination state when it enters low power mode until motion is detected.

This parameter controls the Illumination for DPM barcode reading.

- **Direct Illumination** – scanner uses only the direct (white) illumination. Recommended for use with dot-peened barcodes. Tilt the part 30 degrees.
- **Indirect Illumination** – scanner uses only the (red) illumination. Recommended for use with laser etched barcodes on curved, rough, grainy, highly reflective, visibly machined surfaces or cylinders.
- **Cycle Illumination** – scanner cycles alternately between direct and indirect illumination. The scanner starts with the illumination used during the last successful decode.



Direct Illumination
(0)



Indirect Illumination
(8)



*** Cycle Illumination**
(3)

DPM Rough Shiny Surface Decoding

Parameter # 1904

Enable this parameter to improve decoding of DPM symbols on materials rough from casting or machining marks often found on manufactured parts, as well as on symbols with “hot spots” from machining or lubricating oils and fluids.



NOTE This parameter applies to the DS36X8-DP only.



NOTE Enabling this may adversely impact decoding symbols that do not exhibit rough shiny characteristics.

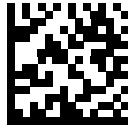

* Disable DPM Rough Shiny Surface Decoding
(0)



Enable DPM Rough Shiny Surface Decoding
(1)

Ultra High Density DPM Decoding

Parameter # 1903

Enable this parameter to improve decoding 2D symbols with module density below 5 mil. This feature is essential for reading 3 mil symbols.

✓ **NOTE** This parameter applies to the DS36X8-DP only.



* Disable Ultra High Density DPM Decoding
(0)



Enable Ultra High Density DPM Decoding
(1)

CHAPTER 7 IMAGING PREFERENCES

Introduction

You can program the digital scanner to perform various functions, or activate different features. This chapter describes imaging preference features and provides programming barcodes for selecting these features.

✓ **NOTE** Only the Symbol Native API (SNAPI) with Imaging interface supports image capture. See [USB Device Type on page 8-5](#) to enable this host.

The digital scanner ships with the settings in [Imaging Preferences Parameter Defaults on page 7-2](#) (also see [Appendix A, Standard Default Parameters](#) for all host device and defaults). If the default values suit requirements, programming is not necessary.

To set feature values, scan a single barcode or a short barcode sequence. The settings are stored in non-volatile memory and are preserved even when you power down the digital scanner.

✓ **NOTE** Most computer monitors allow scanning the barcodes directly on the screen. When scanning from the screen, be sure to set the document magnification to a level where you can see the barcode clearly, and bars and/or spaces are not merging.

To return all features to default values, scan the [Default Parameters on page 6-5](#). Throughout the programming barcode menus, asterisks (*) indicate default values.

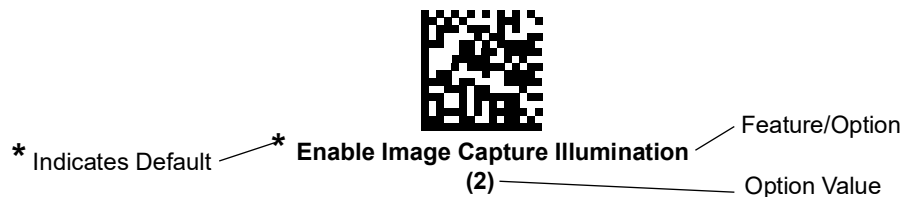

Scanning Sequence Examples

In most cases scanning one barcode sets the parameter value. For example, to disable image capture illumination, scan the **Disable Image Capture Illumination** barcode under *Image Capture Illumination on page 7-5*. The digital scanner issues a fast warble beep and the LED turns green, signifying a successful parameter entry.

Other parameters require scanning several barcodes. See these parameter descriptions for this procedure.

Errors While Scanning

Unless otherwise specified, to correct an error during a scanning sequence, just re-scan the correct parameter.

Imaging Preferences Parameter Defaults

Table 7-1 lists the defaults for imaging preferences parameters. To change the default values, scan the appropriate barcodes in this guide. These new values replace the standard default values in memory. To recall the default parameter values, scan **Restore Defaults on page 6-5*.

✓ **NOTE** See *Appendix A, Standard Default Parameters* for all user preferences, hosts, symbologies, and default parameters.

Table 7-1 *Imaging Preferences Parameter Defaults*

Parameter	Parameter Number	SSI Number	Default	Page Number
Imaging Preferences				
Operational Modes	N/A	N/A	N/A	7-4
Image Capture Illumination	361	F0h 69h	Enable	7-5
Image Capture Autoexposure	360	F0h 68h	Enable	7-5
Fixed Exposure	567	F4h F1h 37h	100	7-6
Gain / Exposure Priority for Snapshot Mode	562	F1h 32h	Autodetect	7-7
Snapshot Mode Timeout	323	F0h 43h	0 (30 Seconds)	7-8
Snapshot Aiming Pattern	300	F0h 2Ch	Enable	7-9
Silence Operational Mode Changes	1293	F8h 05h 0Dh	Disable (do not silence)	7-9
Image Cropping	301	F0h 2Dh	Disable	7-10
Crop to Pixel Addresses	315 316 317 318	F4h F0h 3Bh F4h F0h 3Ch F4h F0h 3Dh F4h F0h 3Eh	0 top 0 left 959 bottom 1279 right	7-11
Image Size (Number of Pixels)	302	F0h 2Eh	Full	7-13

Table 7-1 *Imaging Preferences Parameter Defaults (Continued)*

Parameter	Parameter Number	SSI Number	Default	Page Number
Image Brightness (Target White)	390	F0h 86h	180	7-14
JPEG Image Options	299	F0h 2Bh	Quality	7-14
JPEG Target File Size	561	F1h 31h	160 kB	7-15
JPEG Quality and Size Value	305	F0h 31h	65	7-15
Image Enhancement	564	F1h 34h	Low (1)	7-16
Image File Format Selection	304	F0h 30h	JPEG	7-17
Image Rotation	665	F1h 99h	0°	7-18
Bits per Pixel (BPP)	303	F0h 2Fh	8 BPP	7-19
Signature Capture (DS36X8 HP Only)	93	5Dh	Disable	7-20
Signature Capture Image File Format Selection (DS36X8 HP Only)	313	F0h 39h	JPEG	7-21
Signature Capture Bits per Pixel (BPP) (DS36X8 HP Only)	314	F0h 3Ah	8 BPP	7-22
Signature Capture Width (DS36X8 HP Only)	366	F4h F0h 6Eh	400	7-23
Signature Capture Height (DS36X8 HP Only)	367	F4h F0h 6Fh	100	7-23
Signature Capture JPEG Quality (DS36X8 HP Only)	421	F0h A5h	65	7-24
Video View Finder	324	F0h 44h	Disable	7-24
Video View Finder Image Size	329	F0h 49h	1700 bytes	7-25

Imaging Preferences

The parameters in this chapter control image capture characteristics. Image capture occurs in all modes of operation, including decode, and snapshot.

Operational Modes

The digital scanner has two modes of operation:

- Decode Mode
- Snapshot Mode

Decode Mode

By default, when you pull the trigger the digital scanner attempts to locate and decode enabled barcodes within its field of view. The digital scanner remains in this mode until it decodes a barcode or you release the trigger.

Snapshot Mode

✓ **NOTE** The DS36X8-ER and DS36X8-XR restricts Snapshot Mode to Near Focus only.

Use Snapshot Mode to capture a high-quality image and transmit it to the host. To temporarily enter this mode scan the **Snapshot Mode** barcode. While in this mode the digital scanner blinks the green LED at 1 second intervals to indicate it is not in standard operating (decode) mode.

In Snapshot Mode, the digital scanner turns on its aiming pattern to highlight the area to capture in the image. The next trigger pull instructs the digital scanner to capture a high quality image and transmit it to the host. A short time may pass (less than 2 seconds) between when the trigger is pulled and the image is captured as the digital scanner adjusts to the lighting conditions. Hold the digital scanner steady until the image is captured, denoted by a single beep.

If you do not press the trigger within the Snapshot Mode Timeout period, the digital scanner returns to Decode Mode. Use [Snapshot Mode Timeout on page 7-8](#) to adjust this timeout period. The default timeout period is 30 seconds.

To disable the aiming pattern during Snapshot Mode, see [Snapshot Aiming Pattern on page 7-9](#).



Snapshot Mode

Image Capture Illumination

Parameter # 361 (SSI # F0h 69h)

Selecting **Enable Image Capture Illumination** causes illumination to turn on during every image capture. Disable illumination to prevent the digital scanner from using illumination.

Enabling illumination usually results in superior images. The effectiveness of illumination decreases as the distance to the target increases.



* **Enable Image Capture Illumination**
(1)



Disable Image Capture Illumination
(0)

Image Capture Autoexposure

Parameter # 360 (SSI # F0h 68h)

Select **Enable Image Capture Autoexposure** to allow the digital scanner to control gain settings and exposure (integration) time to best capture an image for the selected operation mode.

Select **Disable Image Capture Autoexposure** to manually adjust the gain and exposure time (see the following pages). This option is only recommended for advanced users with difficult image capture situations.



* **Enable Image Capture Autoexposure**
(1)



Disable Image Capture Autoexposure
(0)

Fixed Exposure

Parameter # 567 (SSI # F4h F1h 37h)

Type: Word

Range: 1 - 1000

This parameter configures the exposure used in manual mode for Snapshot.

Each integer value represents 100 μ s worth of exposure. The default value is 100 which results in an exposure setting of 10 msec.

To set the Fixed Exposure parameter, scan **Fixed Exposure** followed by four numeric barcodes representing the value. Leading zeros are required. For example, to set a Fixed Exposure value of 99, scan 0, 0, 9, 9. See [Appendix H, Numeric Bar Codes](#) for numeric barcodes.



Fixed Exposure
(4 digits)

Gain/Exposure Priority for Snapshot Mode

Parameter # 562 (SSI # F1h 32h)

This parameter alters the digital scanner's gain exposure priority when it acquires an image in Snapshot Mode in auto exposure mode.

- Scan **Low Exposure Priority** to set a mode in which the digital scanner favors higher gain over exposure to capture an image. This results in an image that is less susceptible to motion blur at the expense of noise artifacts. However, for most applications, the amount of noise is acceptable.
- Scan **Low Gain Priority** to set a mode in which the digital scanner favors longer exposure time rather than higher gain to capture an image. This ensures that the image is less noisy and produces fewer artifacts during post processing activities like image enhancement (sharpening). The mode is recommended for fixed mount / fixed object image capture since the image acquired is susceptible to motion blur.
- Scan **Autodetect** (default) to set a mode in which the digital scanner automatically selects Gain Priority or Low Exposure Priority mode for Snapshot Mode. If the digital scanner is in a magnetic reed switch enabled stand (or it is configured in Blink Mode), it uses Low Gain Priority mode. Otherwise, it uses the Low Exposure Priority mode.



Low Gain Priority
(0)



Low Exposure Priority
(1)



*** Autodetect**
(2)

Snapshot Mode Timeout

Parameter # 323 (SSI # F0h 43h)

This parameter sets the amount of time the digital scanner remains in Snapshot Mode. The digital scanner exits Snapshot Mode when you pull the trigger, or when the Snapshot Mode Timeout elapses. To set this timeout value, scan the **Set Snapshot Mode Timeout** barcode below followed by a barcode from [Appendix H, Numeric Bar Codes](#). The default value is 0 which represents 30 seconds; values increment by 30. For example, 1 = 60 seconds, 2 = 90 seconds, etc.

To quickly re-set the default timeout to 30 seconds, scan the **30 Seconds** barcode below.

If you select **No Timeout**, the digital scanner remains in Snapshot Mode until you pull the trigger.



Set Snapshot Mode Timeout



* 30 Seconds
(0)



No Timeout
(255)

Snapshot Aiming Pattern

Parameter # 300 (SSI # F0h 2Ch)

Select **Enable Snapshot Aiming Pattern** to project the aiming pattern when in Snapshot Mode, or **Disable Snapshot Aiming Pattern** to turn the aiming pattern off.



* Enable Snapshot Aiming Pattern
(1)



Disable Snapshot Aiming Pattern
(0)

Silence Operational Mode Changes

Parameter # 1293 (SSI # F8h 05h 0Dh)

Enable this feature to silence the beeper when switching between operational modes (e.g., from Decode Mode to Snapshot Mode).



Silence Operational Mode Changes (Enable)
(1)



* Do Not Silence Operational Mode Changes (Disable)
(0)

Image Cropping

Parameter # 301 (SSI # F0h 2Dh)

- ✓ **NOTE** The full resolution value for the HP and HD configuration is 1280 x 960. The full resolution value for the SR and ER configurations is 1280 x 800. The full resolution value for the XR configuration is 1920 x 1080.

This parameter crops a captured image. Select **Disable Image Cropping** to present the full 1200 x 800 pixels. Select **Enable Image Cropping** to crop the image to the pixel addresses set in [Crop to Pixel Addresses on page 7-11](#).



Enable Image Cropping
(1)



* Disable Image Cropping
(Use Full 1280 x 800 pixels for SR, ER Configurations;
Use Full 1280 x 960 pixels for HP, HD Configurations)
(0)

Crop to Pixel Addresses

Parameter # 315 (SSI # F4h F0h 3Bh) (Top)

Parameter # 316 (SSI # F4h F0h 3Ch) (Left)

Parameter # 317 (SSI # F4h F0h 3Dh) (Bottom)

Parameter # 318 (SSI # F4h F0h 3Eh) (Right)

- ✓ **NOTE** The full resolution value for the HP and HD configuration is 1280 x 960. The full resolution value for the SR and ER configurations is 1280 x 800. The full resolution value for the XR configuration is 1920 x 1080.

If you selected **Enable Image Cropping**, set the pixel addresses from (0,0) to (1279 x 959) to crop to.

Columns are numbered from 0 to 1279, rows from 0 to 959. Specify four values for Top, Left, Bottom, and Right, where Top and Bottom correspond to row pixel addresses, and Left and Right correspond to column pixel addresses. For example, for a 4 row x 8 column image in the extreme bottom-right section of the image set the following values:

Top = 959, Bottom = 959, Left = 1272, Right = 1279

To set the crop to pixel address, scan each pixel address barcode below followed by four numeric barcodes representing the value. Leading zeros are required. For example, to crop the top pixel address to 3, scan 0, 0, 0, 3. See [Appendix H, Numeric Bar Codes](#) for numeric barcodes. The defaults are:

Top = 0, Bottom = 959, Left = 0, Right = 1279

- ✓ **NOTE** The digital scanner has a cropping resolution of 4 pixels. Setting the cropping area to less than 4 pixels (after resolution adjustment, see [Image Size \(Number of Pixels\) on page 7-13](#)) transfers the entire image.



Top Pixel Address
(0 - 959 Decimal)



Left Pixel Address
(0 - 1279 Decimal)

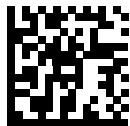

Bottom Pixel Address
(0 - 959 Decimal)



Right Pixel Address
(0 - 1279 Decimal)

Image Size (Number of Pixels)

Parameter # 302 (SSI # F0h 2Eh)

This option alters image resolution before compression. Multiple pixels are combined to one pixel, resulting in a smaller image containing the original content with reduced resolution.

Select one of the following values:

Table 7-2 *Image Size*

Resolution Value	DS36X8 SR, ER, XR	DS36X8 HP, HD
Full	1280 x 800	1280 x 960
1/2	640 x 400	640 x 480
1/4	320 x 200	320 x 240



* Full Resolution
(0)

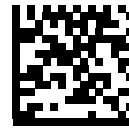

1/2 Resolution
(1)



1/4 Resolution
(3)

Image Brightness (Target White)

Parameter # 390 (SSI # F0h 86h)

Type: Byte

Range: 1 - 240

This parameter sets the Target White value used in Snapshot mode when using auto exposure. White and black are defined as 240 decimal and 1, respectively. Setting the value to the factory default of 180 sets the white level of the image to ~180.

To set the Image Brightness parameter, scan **Image Brightness** below followed by three numeric barcodes representing the value. Leading zeros are required. For example, to set an Image Brightness value of 99, scan 0, 9, 9. See [Appendix H, Numeric Bar Codes](#) for numeric barcodes.



* 180



Image Brightness
(3 digits)

JPEG Image Options

Parameter # 299 (SSI # F0h 2Bh)

Select an option to optimize JPEG images for either size or for quality. Scan the **JPEG Quality Selector** barcode to use a quality value; the digital scanner then selects the corresponding image size. Scan the **JPEG Size Selector** barcode to use a size value; the digital scanner then selects the best image quality.



* JPEG Quality Selector
(1)



JPEG Size Selector
(0)

JPEG Target File Size

Parameter # 561 (SSI # F1h 31h)

Type: Word

Range: 5-350

This parameter defines the target JPEG file size in terms 1 Kilobytes (1024 bytes). The default value is 160 kB which represents 160 Kilobytes.



CAUTION JPEG compress may take 10 to 15 seconds based on the amount of information in the target image. Scanning **JPEG Quality Selector** (default setting) on [page 7-14](#) produces a compressed image that is consistent in quality and compression time.

To set the JPEG Target File Size parameter, scan **JPEG Target File Size** below followed by three numeric barcodes representing the value. Leading zeros are required. For example, to set an image file size value of 99, scan 0, 9, 9 in [Appendix H, Numeric Bar Codes](#).

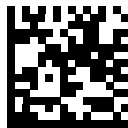

JPEG Target File Size
(3 digits)

JPEG Quality and Size Value

JPEG Quality = Parameter # 305 (SSI # F0h 31h)

If you selected **JPEG Quality Selector**, scan the **JPEG Quality Value** barcode followed by 3 barcodes from [Appendix H, Numeric Bar Codes](#) corresponding to a value from 5 to 100, where 100 represents the highest quality image.



JPEG Quality Value
(Default: 065)
(5 - 100 Decimal)

Image Enhancement

Parameter # 564 (SSI # F1h 34h)

This parameter configures the digital scanner's Image Enhance feature. This feature uses a combination of edge sharpening and contrast enhancement to produce an image that is visually pleasing.

The levels of image enhancement are:

- Off (0)
- Low (1) - Default
- Med (2)
- High (3).



Off
(0)



* Low
(1)



Medium
(2)



High
(3)

Image File Format Selector

Parameter # 304 (SSI # F0h 30h)

Select an image format appropriate for the system (BMP, TIFF, or JPEG). The digital scanner stores captured images in the selected format.



BMP File Format
(3)



*** JPEG File Format**
(1)



TIFF File Format
(4)

Image Rotation

Parameter # 665 (SSI # F1h 99h)

This parameter controls the rotation of the image by 0, 90, 180, or 270 degrees.



* Rotate 0°
(0)



Rotate 90°
(1)



Rotate 180°
(2)



Rotate 270°
(3)

Bits Per Pixel

Parameter # 303 (SSI # F0h 2Fh)

Select the number of significant bits per pixel (BPP) to use when capturing an image. Select **1 BPP** for a black and white image, **4 BPP** to assign 1 of 16 levels of grey to each pixel, or **8 BPP** to assign 1 of 256 levels of grey to each pixel.



NOTE The digital scanner ignores these settings for JPEG file formats, which only support **8 BPP**.

The digital scanner ignores 1 BPP for TIFF file formats, which only support **4 BPP** and **8 BPP**. 1 BPP is coerced to 4 BPP for TIFF file formats.

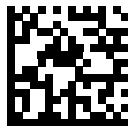

1 BPP
(0)



4 BPP
(1)

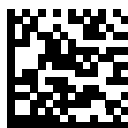

* 8 BPP
(2)

Signature Capture

Parameter # 93 (SSI # 5Dh)

✓ **NOTE** Signature capture only applies to the DS36X8-HP.

For the DS3678-HP with Display and Keypad, signature captures display on the host (not on the device display).

A signature capture barcode is a special-purpose symbology which delineates a signature capture area in a document with a machine-readable format. The recognition pattern is variable so it can optionally provide an index to various signatures. The region inside the barcode pattern is considered the signature capture area. See [Appendix K, Signature Capture Code](#) for more information.

Output File Format

Decoding a signature capture barcode de-skews the signature image and converts the image to a BMP, JPEG, or TIFF file format. The output data includes the file descriptor followed by the formatted signature image.

Table 7-3 *Output File Format*

File Descriptor			Signature Image
Output Format (1 byte)	Signature Type (1 byte)	Signature Image Size (4 bytes) (BIG Endian)	
JPEG - 1 BMP - 3 TIFF - 4	1-8	0x00000400	0x00010203....

To enable or disable Signature Capture, scan the appropriate barcode below.

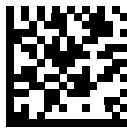

Enable Signature Capture
(1)



* Disable Signature Capture
(0)

Signature Capture File Format Selector

Parameter # 313 (SSI # F0h 39h)

✓ **NOTE** Signature capture only applies to the DS36X8-HP.

Select a signature file format appropriate for the system (BMP, TIFF, or JPEG). The digital scanner stores captured signatures in the selected format.



BMP Signature Format
(3)



*** JPEG Signature Format**
(1)

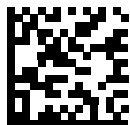

TIFF Signature Format
(4)

Signature Capture Bits Per Pixel

Parameter # 314 (SSI # F0h 3Ah)

✓ **NOTE** Signature capture only applies to the DS36X8-HP.

Select the number of significant bits per pixel (BPP) to use when capturing a signature. Select **1 BPP** for a black and white image, **4 BPP** to assign 1 of 16 levels of grey to each pixel, or **8 BPP** to assign 1 of 256 levels of grey to each pixel.

✓ **NOTE** The digital scanner ignores these settings for JPEG file formats, which only support **8 BPP**.



1 BPP
(0)



4 BPP
(1)

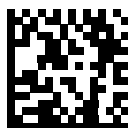

* 8 BPP
(2)

Signature Capture Width

Parameter # 366 (SSI # F4h F0h 6Eh)

✓ **NOTE** Signature capture only applies to the DS36X8-HP.

The aspect ratio of the Signature Capture Width and Signature Capture Height parameters must match that of the signature capture area. For example, a 4 x 1 inch signature capture area would require a 4 to 1 aspect ratio of width to height.

To set the width of the signature capture box, scan the **Signature Capture Width** barcode, followed by 3 barcodes from [Appendix H, Numeric Bar Codes](#) corresponding to a value in the range of 016 to 640 decimal.



Signature Capture Width
(Default: 400)
(016 - 640 Decimal)

Signature Capture Height

Parameter # 367 (SSI # F4h F0h 6Fh)

✓ **NOTE** Signature capture only applies to the DS36X8-HP.

To set the height of the signature capture box, scan the **Signature Capture Height** barcode, followed by 3 barcodes from [Appendix H, Numeric Bar Codes](#) corresponding to a value in the range of 016 to 480 decimal.



Signature Capture Height (Default: 100)
(016 - 480 Decimal)

Signature Capture JPEG Quality

Parameter # 421 (SSI # F0h A5h)

✓ **NOTE** Signature capture only applies to the DS36X8-HP.

Scan the **JPEG Quality Value** barcode followed by 3 barcodes from [Appendix H, Numeric Bar Codes](#) corresponding to a value from 005 to 100, where 100 represents the highest quality image.



JPEG Quality Value (Default: 065)
(5 - 100 Decimal)

Video View Finder

Parameter # 324 (SSI # F0h 44h)

Select **Enable Video View Finder** to project the video view finder while in Video Mode, or **Disable Video View Finder** to turn the video view finder off.

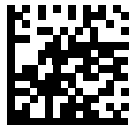

* Disable Video View Finder
(0)



Enable Video View Finder
(1)

Video View Finder Image Size

Parameter # 329 (SSI # F0h 49h)

Select the number of 100-byte blocks. Values range from 800 to 12,000 bytes. Selecting a smaller value transmits more frames per second; selecting a larger value increases video quality.

To set the Video View Finder Image Size, scan the barcode below followed by three barcodes from [Appendix H, Numeric Bar Codes](#) corresponding to the 100-byte value from 800 to 12,000 bytes. For example, to select 1500 bytes, enter 0, 1, 5. To select 900 bytes, enter 0, 0, 9. The default is 1700 bytes.



Video View Finder Image Size

CHAPTER 8 USB INTERFACE

Introduction

This chapter provides instructions for programming the digital scanner to interface with a USB host. The digital scanner connects directly to a USB host, or a powered USB hub. The USB host can power the digital scanner.

Throughout the programming barcode menus, default values are indicated with asterisks (*).



Indicates Default — **HID Keyboard Emulation** — Feature/Option

Connecting a USB Interface

The digital scanner connects to USB capable hosts including:

- TGIS (IBM) terminals
- Apple™ desktops and notebooks
- Other network computers that support more than one keyboard.

The following operating systems support the digital scanner through USB:

- Windows® XP, 7, 8, 10
- MacOS 8.5 - MacOS 10.6
- IBM 4690 OS.

Connecting DS3678 to USB Interface

The digital scanner also interfaces with other USB hosts which support USB Human Interface Devices (HID).

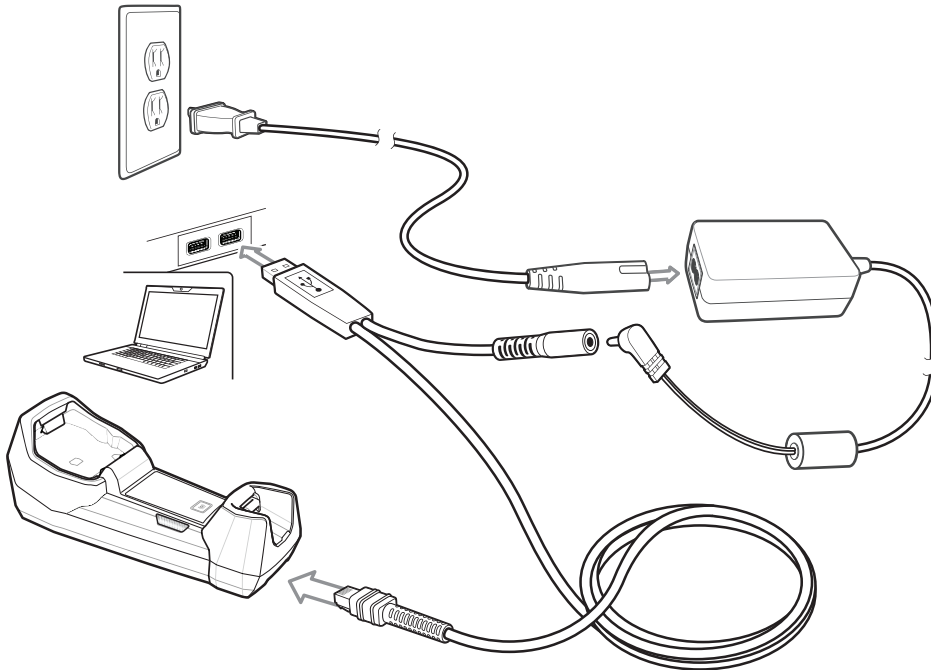

Figure 8-1 *USB Connection to DS3678*

To connect the cradle to a USB host:

1. Attach the modular connector of the USB interface cable to the cable interface port on the cradle. See [Connecting the Cradle on page 1-6](#).
2. Plug the series A connector in the USB host or hub, or plug the Plus Power connector in an available port of the IBM SurePOS terminal.
3. Connect an external power supply if desired.
4. Ensure all connections are secure.
5. Pair the digital scanner to the cradle by scanning the barcode on the cradle.
6. Select the USB device type by scanning the appropriate barcode from [USB Device Type on page 8-5](#).
7. On first installation when using Windows, the software displays a prompt to select or install the *Human Interface Device* driver. To install the Human Interface Device driver provided by Windows, click **Next** through all the choices and click **Finished** on the last choice. The digital scanner powers up during this installation.
8. To modify any other parameter options, scan the appropriate barcodes in this chapter.

✓ **NOTE** Interface cables vary depending on configuration. The connectors illustrated in [Figure 8-1](#) are examples only. The connectors may be different from those illustrated, but the steps to connect the cradle remain the same.

✓ **NOTE** Disconnect the host cables before the power supply, or the digital scanner may not recognize the new host.

If problems occur, see [Troubleshooting on page 4-3](#).

Connecting DS3608 to USB Interface

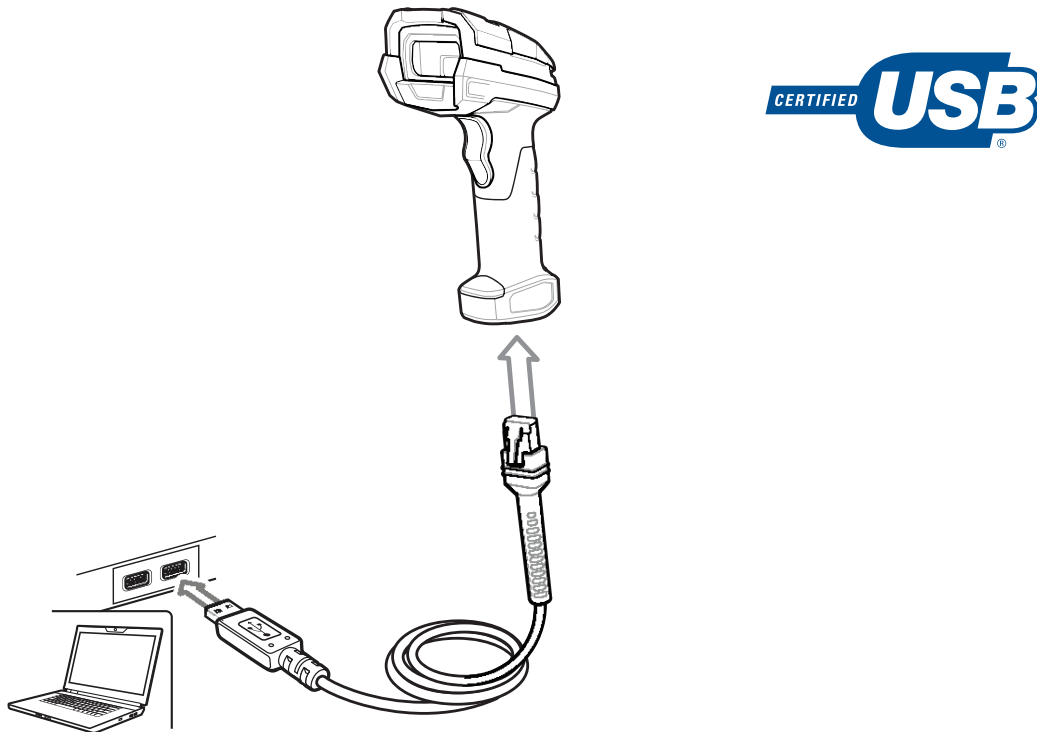

Figure 8-2 *USB Connection to DS3608*

To connect the USB interface to a corded DS3608:

1. Attach the modular connector of the USB interface cable to the host port on the bottom of the digital scanner.
2. Plug the series A connector in the USB host or hub, or plug the Plus Power connector in an available port of the IBM SurePOS terminal.
3. Select the USB device type by scanning the appropriate barcode from [USB Device Type on page 8-5](#).

✓ **NOTE** The interface cable automatically detects the host interface type and uses the default setting. If the default (*) does not meet your requirements, scan another host barcode.

4. On first installation when using Windows, the software prompts to select or install the Human Interface Device driver. To install this driver, provided by Windows, click **Next** through all the choices and click **Finished** on the last choice. The scanner powers up during this installation.
5. To modify any other parameter options, scan the appropriate barcodes in this chapter.

If problems occur with the system, see [Troubleshooting on page 4-3](#).

USB Parameter Defaults

Table 8-1 lists the defaults for USB host parameters. If any option needs to be changed, scan the appropriate barcode(s) provided in the Parameter Descriptions section beginning on [page 8-5](#).

- ✓ **NOTE** See [Appendix A, Standard Default Parameters](#) for all user preferences, hosts, symbologies, and default parameters.
- ✓ **NOTE** See [Appendix B, Country Codes](#) for USB Country Keyboard Types (Country Codes).

Table 8-1 *USB Host Default Table*

Parameter	Default	Page Number
USB Host Parameters		
USB Device Type	HID Keyboard Emulation	8-6
Symbol Native API (SNAPI) Status Handshaking	Enable	8-8
USB Keystroke Delay	No Delay	8-9
USB CAPS Lock Override	Disable	8-9
USB Ignore Unknown Characters	Send	8-10
USB Convert Unknown to Code 39	Disable	8-10
Emulate Keypad	Enable	8-11
Emulate Keypad with Leading Zero	Enable	8-11
Quick Keypad Emulation	Enable	8-12
USB FN1 Substitution	Disable	8-12
Function Key Mapping	Disable	8-13
Simulated Caps Lock	Disable	8-13
Convert Case	No Case Conversion	8-14
USB Static CDC	Enable	8-15
Ignore Beep	Enable	8-16
Ignore Bar Code Configuration	Enable	8-16
USB Polling Interval	3 msec	8-17
USB Fast HID	Enable	8-19
IBM Specification Version	Version 2.2	8-19

USB Host Parameter

USB Device Type

Select the desired USB device type.



NOTES

1. When changing USB device types, the scanner automatically restarts. The scanner issues a power-up beep sequence.
2. Before selecting *USB CDC Host (Note 1) on page 8-7*, install the Zebra USB CDC Driver (located at: <https://zebra.com/us/en/support-downloads/software/drivers/usb-cdc-driver.html>) on the host to ensure the scanner does not stall during power up (due to a failure to enumerate USB).

To recover a stalled scanner:

- Install the CDC Driver.
or
 - For the cordless DS3678, unplug the USB cable and add power. Connect the scanner via Bluetooth and scan **USB HID Keyboard** or another host.
 - For the corded DS3608, unplug the USB cable, while holding the trigger, re-plug the USB cable. After 5 seconds, the scanner temporarily comes up in HID Keyboard, scan another host.
3. Select **IBM Hand-held USB** to disable data transmission when an IBM register issues a Scan Disable command. Aim, illumination, and decoding is still permitted. Select **OPOS (IBM Hand-held with Full Disable)** to completely shut off the scanner when an IBM register issues a Scan Disable command, including aim, illumination, decoding, and data transmission.

USB Device Type (continued)



*** USB HID Keyboard**



IBM Table-top USB



IBM Hand-held USB



**OPOS
(IBM Hand-held with Full Disable)**

USB Device Type (continued)

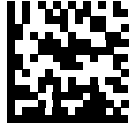

SSI over USB CDC



USB CDC Host
(Note 1)



Symbol Native API (SNAPI) without Imaging Interface



Symbol Native API (SNAPI) with Imaging Interface



Datalogic USB CDC Host Variant

Symbol Native API (SNAPI) Status Handshaking

After selecting a SNAPI interface as the USB device type, select whether to enable or disable status handshaking.



* Enable SNAPI Status Handshaking



Disable SNAPI Status Handshaking

USB Keystroke Delay

This parameter sets the delay, in milliseconds, between emulated keystrokes. Scan a barcode below to increase the delay when hosts require a slower transmission of data.



* No Delay

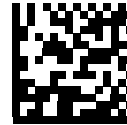

Medium Delay (20 msec)



Long Delay (40 msec)

USB CAPS Lock Override

This option applies only to the HID Keyboard Emulation device. When enabled, the case of the data is preserved regardless of the state of the caps lock key. This setting is always enabled for the “Japanese, Windows (ASCII)” keyboard type and can not be disabled.



Override Caps Lock Key
(Enable)



* Do Not Override Caps Lock Key
(Disable)

USB Ignore Unknown Characters

This option applies only to the HID Keyboard Emulation device and IBM device. Unknown characters are characters the host does not recognize. When **Send Bar Codes With Unknown Characters** is selected, all barcode data is sent except for unknown characters, and no error beeps sound. When **Do Not Send Bar Codes With Unknown Characters** is selected, barcode data is sent up to the first unknown character, then the digital scanner issues an error beep.



* **Send Bar Codes with Unknown Characters**



Do Not Send Bar Codes with Unknown Characters

USB Convert Unknown to Code 39

This option applies only to the IBM Hand-held, IBM Table-top, and OPOS devices. Scan a barcode below to enable or disable converting unknown barcode type data to Code 39.



* **Disable Convert Unknown to Code 39**



Enable Convert Unknown to Code 39

Emulate Keypad

When enabled, all characters are sent as ASCII sequences over the numeric keypad. For example ASCII A would be sent as “ALT make” 0 6 5 “ALT Break.”



Disable Keypad Emulation



*** Enable Keypad Emulation**

Emulate Keypad with Leading Zero

Enable this to send character sequences sent over the numeric keypad as ISO characters which have a leading zero. For example ASCII A transmits as “ALT MAKE” 0 0 6 5 “ALT BREAK”.



Disable Keypad Emulation with Leading Zero



*** Enable Keypad Emulation with Leading Zero**

Quick Keypad Emulation

This option applies only to the HID Keyboard Emulation Device and if Emulate Keypad is enabled. This parameter enables a quicker method of keypad emulation where ASCII sequences are only sent for ASCII characters not found on the keyboard. The default value is **Enable**.



* **Enable Quick Keypad Emulation**



Disable Quick Keypad Emulation

USB Keyboard FN 1 Substitution

This option applies only to the USB HID Keyboard Emulation device. When enabled, this allows replacement of any FN 1 characters in an EAN 128 barcode with a Key Category and value chosen by the user (see [FN1 Substitution Values on page 6-45](#) to set the Key Category and Key Value).



Enable FN1 Substitution



* **Disable FN1 Substitution**

Function Key Mapping

ASCII values under 32 are normally sent as a control-key sequences (see [Table I on page I-1](#)). When this parameter is enabled, the keys in bold are sent in place of the standard key mapping. Table entries that do not have a bold entry remain the same whether or not this parameter is enabled.



* Disable Function Key Mapping



Enable Function Key Mapping

Simulated Caps Lock

When enabled, the digital scanner inverts upper and lower case characters on the digital scanner barcode as if the Caps Lock state is enabled on the keyboard. This inversion is done regardless of the current state of the keyboard's Caps Lock state.



NOTE This feature is ignored if you set [Convert Case](#) to **Convert All to Upper Case** or **Convert All to Lower Case**.



* Disable Simulated Caps Lock



Enable Simulated Caps Lock

Convert Case

When enabled, the digital scanner converts all barcode data to the selected case.



* No Case Conversion



Convert All to Upper Case



Convert All to Lower Case

USB Static CDC

Parameter # 670

When disabled, each device connected consumes another COM port (first device = COM1, second device = COM2, third device = COM3, etc.)

When enabled, each device connects to the same COM port.



* Enable USB Static CDC
(1)



Disable USB Static CDC
(0)

Optional USB Parameters

If you configure the digital scanner and find the settings were not saved, or changed, when the system is restarted scan the barcodes that follow to override USB interface defaults.

Scan a barcode below after setting defaults and before configuring the digital scanner.

Ignore Beep

The host can send a beep request to the digital scanner. When this parameter is enabled, the request is not sent to the attached digital scanner. All directives are still acknowledged to the USB host as if it were processed.



Disable Ignore Beep



*** Enable Ignore Beep**

Ignore Bar Code Configuration

The host has the ability to enable/disable code types. When this parameter is enabled, the request is not sent to the attached digital scanner. All directives are still acknowledged to the USB host as if it were processed.



Disable Ignore Bar Code Configuration



*** Enable Ignore Bar Code Configuration**

USB Polling Interval

Scan a barcode below to set the polling interval. The polling interval determines the rate at which data can be sent between the scanner and host computer. A lower number indicates a faster data rate.



NOTE When changing USB Device Types, the digital scanner automatically restarts and issues a disconnect-reconnect beep sequence.



IMPORTANT Ensure your host machine can handle the selected data rate.

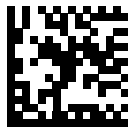

1 msec



2 msec



* 3 msec



4 msec

USB Polling Interval (continued)

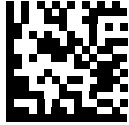

5 msec



6 msec



7 msec



8 msec



9 msec



10 msec

USB Fast HID

This option transmits USB HID data at a faster rate.



* Enable USB Fast HID



Disable USB Fast HID

IBM Specification Version

The IBM USB interface specification version selected defines how code types are reported over the IBM USB interface.

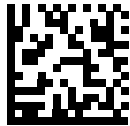

Original Specification



* Version 2.2

ASCII Character Set for USB

See [Appendix H, Numeric Bar Codes](#) for the following:

- ASCII Character Set ([Table I-1 on page I-1](#))
- ALT Key Character Set ([Table I-2 on page I-6](#))
- GUI Key Character Set ([Table I-3 on page I-7](#))
- F Key Character Set ([Table I-5 on page I-11](#)).

CHAPTER 9 SSI INTERFACE

Introduction

This chapter describes the system requirements of the Simple Serial Interface (SSI), which provides a communications link between Zebra decoders (e.g., scan engines, slot scanners, Hand-held scanners, two-dimensional scanners, Hands-free scanners, and RF base stations) and a serial host. It provides the means for the host to control the decoder or scanner.

Communications

All communication between the digital scanner and host occurs over the hardware interface lines using the SSI protocol. Refer to the *Simple Serial Interface Programmer's Guide*, p/n 72-40451-xx, for more information on SSI.

The host and the digital scanner exchange messages in packets. A packet is a collection of bytes framed by the proper SSI protocol formatting bytes. The maximum number of bytes per packet that the SSI protocol allows for any transaction is 257 (255 bytes + 2 byte checksum).

Decode data can be sent as ASCII data (unpacketed), or as part of a larger message (packeted), depending on the digital scanner configuration.

SSI performs the following functions for the host device:

- Maintains a bi-directional interface with the digital scanner
- Allows the host to send commands that control the digital scanner
- Passes data from the digital scanner to a host device in SSI packet format or straight decode message.

The working environment of the SSI consists of a digital scanner, a serial cable which attaches to the host device, and in some instances, a power supply.

SSI transmits all decode data including special formatting (e.g., AIM ID). Parameter settings can control the format of the transmitted data.

The digital scanner can also send parameter information, product identification information, or event codes to the host.

All commands sent between the digital scanner and host must use the format described in the SSI Message Formats section. [SSI Transactions on page 9-3](#) describes the required sequence of messages in specific cases.

Table 9-1 lists all the SSI opcodes the digital scanner supports. It identifies the SSI partner allowed to send a message of each type. The host transmits opcodes designated type H. The digital scanner transmits type D opcodes, and either partner can transmit Host/Decoder (H/D) types.

Table 9-1 SSI Commands

Name	Type	Opcode	Description
AIM_OFF	H	0xC4	Deactivate aim pattern.
AIM_ON	H	0xC5	Activate aim pattern.
BEEP	H	0xE6	Sound the beeper.
CAPABILITIES_REPLY	D	0xD4	Reply to CAPABILITIES_REQUEST; contains a list of the capabilities and commands the decoder supports.
CAPABILITIES_REQUEST	H	0xD3	Request capabilities report from the decoder.
CMD_ACK	H/D	0xD0	Positive acknowledgment of received packet.
CMD_NAK	H/D	0xD1	Negative acknowledgment of received packet.
DECODE_DATA	D	0xF3	Decode data in SSI packet format.
EVENT	D	0xF6	Event indicated by associated event code.
LED_OFF	H	0xE8	De-activate LED output.
LED_ON	H	0xE7	Activate LED output.
PARAM_DEFAULTS	H	0xC8	Set parameter default values.
PARAM_REQUEST	H	0xC7	Request values of certain parameters.
PARAM_SEND	H/D	0xC6	Send parameter values.
REPLY_ID	D	0xA6	Reply to REQUEST_ID; contains decoder's serial number.
REPLY_REVISION	D	0xA4	Reply to REQUEST_REVISION contains decoder's software/hardware configuration.
REQUEST_ID	H	0xA3	Request the decoder's serial number.
REQUEST_REVISION	H	0xA3	Request the decoder's configuration.
SCAN_DISABLE	H	0xEA	Prevent the operator from scanning barcodes.
SCAN_ENABLE	H	0xE9	Permit barcode scanning.
SLEEP	H	0xEB	Request to place the decoder into low power.
START_DECODE	H	0xE4	Tell decoder to attempt to decode a barcode.
STOP_DECODE	H	0xE5	Tell decoder to abort a decode attempt.
WAKEUP	H	N/A	Wakeup decoder after it has entered low power mode.

For details of the SSI protocol, refer to the *Simple Serial Interface Programmer's Guide* (72-40451-xx).

SSI Transactions

General Data Transactions

ACK/NAK Handshaking

If you enable ACK/NAK handshaking, all packeted messages must have a CMD_ACK or CMD_NAK response, unless the command description states otherwise. This parameter is enabled by default. Zebra recommends leaving this handshaking enabled to provide feedback to the host. Raw decode data and WAKEUP do not use ACK/NAK handshaking since they are not packeted data.

Following is an example of a problem which can occur if you disable ACK/NAK handshaking:

- The host sends a PARAM_SEND message to the digital scanner to change the baud rate from 9600 to 19200.
- The digital scanner cannot interpret the message.
- The digital scanner does not implement the change the host requested.
- The host assumes that the parameter change occurred and acts accordingly.
- Communication is lost because the change did not occur on both sides.

If you enable ACK/NAK handshaking, the following occurs:

- The host sends a PARAM_SEND message.
- The digital scanner cannot interpret the message.
- The digital scanner CMD_NAKs the message.
- The host resends the message.
- The digital scanner receives the message successfully, responds with CMD_ACK, and implements parameter changes.

Transfer of Decode Data

The Decode Data Packet Format parameter controls how decode data is sent to the host. Set this parameter to send the data in a DECODE_DATA packet. Clear this parameter to transmit the data as raw ASCII data.

✓ **NOTE** When transmitting decode data as raw ASCII data, ACK/NAK handshaking does not apply regardless of the state of the ACK/NAK handshaking parameter.

ACK/NAK Enabled and Packeted Data

The digital scanner sends a DECODE_DATA message after a successful decode. The digital scanner waits for a programmable time-out for a CMD_ACK response. If it does not receive the response, the digital scanner tries to send two more times before issuing a host transmission error. If the digital scanner receives a CMD_NAK from the host, it may attempt a retry depending on the cause field of the CMD_NAK message.

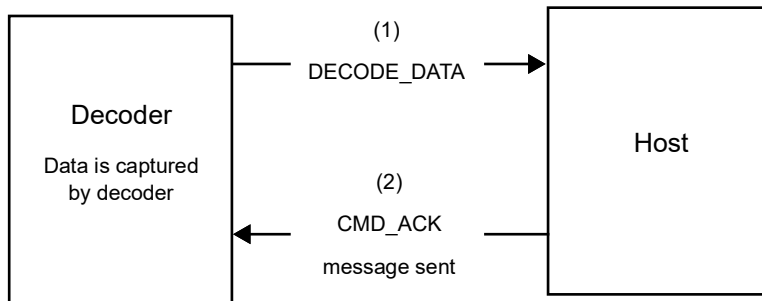

Figure 9-1 ACK/NAK Enabled and Packeted Data

ACK/NAK Enabled and Unpacketed ASCII Data

Even though the ACK/NAK handshaking is enabled, no handshaking occurs because the handshaking applies only to packeted data. In this example the **packeted_decode** parameter is disabled.

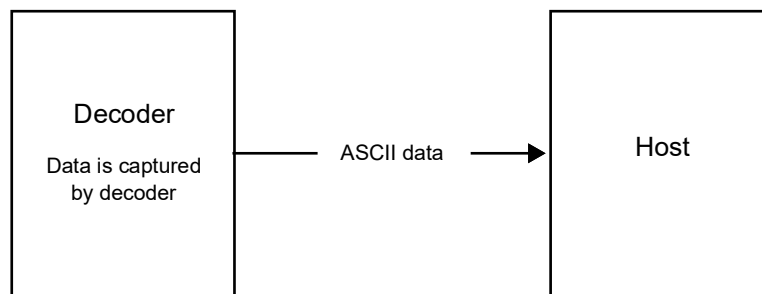

Figure 9-2 ACK/NAK Enabled and Unpacketed ASCII Data

ACK/NAK Disabled and Packeted DECODE_DATA

In this example ACK/NAK does not occur even though **packeted_decode** is enabled because the ACK/NAK handshaking parameter is disabled.

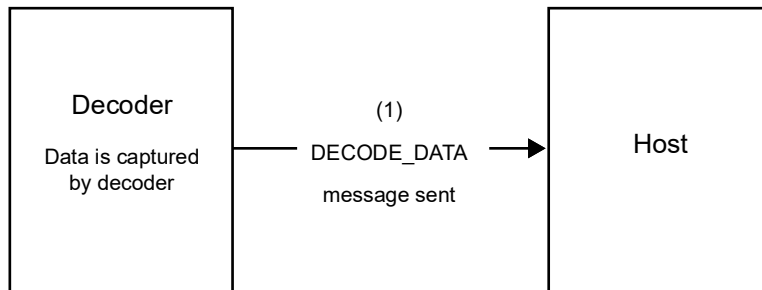

Figure 9-3 ACK/NAK Disabled and Packeted DECODE_DATA

ACK/NAK Disabled and Unpacketed ASCII Data

Data captured by the digital scanner is sent to the host.

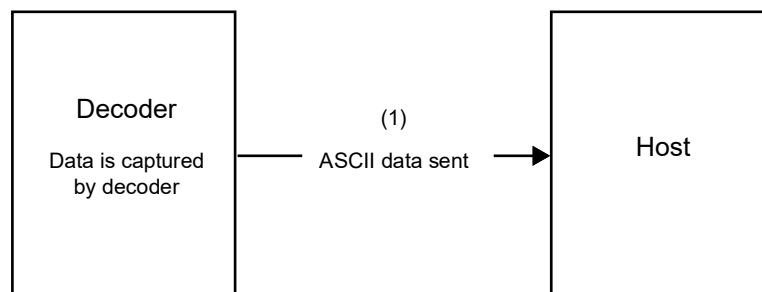

Figure 9-4 ACK/NAK Disabled and Unpacketed ASCII Data

Communication Summary

RTS/CTS Lines

All communication must use RTS/CTS handshaking as described in the *Simple Serial Interface Programmer's Guide*, p/n 72-40451-xx. If hardware handshaking is disabled or bypassed, the WAKEUP command must be sent prior to all other communications, or the first byte of a communication message may be lost during the digital scanner wakeup sequence.

ACK/NAK Option

Enable or disable ACK/NAK handshaking. This handshaking is enabled by default and Zebra recommends leaving it enabled. Disabling this handshaking can cause communication problems, as handshaking is the only acknowledgment that a message was received, and if it was received correctly. ACK/NAK is not used with unpacketed decode data regardless of whether or not it is enabled.

Number of Data Bits

All communication with the digital scanner must use 8-bit data.

Serial Response Time-out

The Serial Response Time-out parameter determines how long to wait for a handshaking response before trying again, or aborting any further attempts. Set the same value for both the host and digital scanner.

- ✓ **NOTE** You can temporarily change the Serial Response Time-out when the host takes longer to process an ACK or longer data string. Zebra does not recommend frequent permanent changes due to limited write cycles of non-volatile memory.

Retries

When sending data, the host should resend twice after the initial send if the digital scanner does not respond with an ACK or NAK (if ACK/NAK handshaking is enabled), or response data (e.g., PARAM_SEND, REPLY_REVISION). If the digital scanner replies with a NAK RESEND, the host resends the data. All resent messages must have the resend bit set in the Status byte.

The digital scanner resends data two times after the initial send if the host fails to reply with an ACK or NAK (if ACK/NAK handshaking is enabled).

Baud Rate, Stop Bits, Parity, Response Time-out, ACK/NAK Handshake

If you use PARAM_SEND to change these serial parameters, the ACK response to the PARAM_SEND uses the previous values for these parameters. The new values then take effect for the next transaction.

Errors

The digital scanner issues a communication error when:

- The CTS line is asserted when the digital scanner tries to transmit, and is still asserted on each of 2 successive retries
- Failure to receive an ACK or NAK after initial transmit and two resends.

Things to Remember When Using SSI Communication

When not using hardware handshaking, space messages sufficiently apart. The host must not communicate with the digital scanner if the digital scanner is transmitting.

When using hardware handshaking, frame each message properly with the handshaking signals. Do not try to send two commands within the same handshaking frame.

There is a permanent/temporary bit in the PARAM_SEND message. Removing power from the digital scanner discards temporary changes. Permanent changes are written to non-volatile memory. Frequent changes shorten the life of the non-volatile memory.

Using Time Delay to Low Power Mode with SSI

[Time Delay to Low Power Mode on page 6-16](#) provides barcodes to select a general time delay. To program a more specific delay value, use an SSI command according to [Table 9-2](#).

Table 9-2 Values for Selecting Time Delay to Low Power

Value	Timeout	Value	Timeout	Value	Timeout	Value	Timeout
0x00	15 Mins	0x10	1 Sec	0x20	1 Min	0x30	1 Hour
0x01	30 Mins	0x11	1 Sec	0x21	1 Min	0x31	1 Hour
0x02	60 Mins	0x12	2 Secs	0x22	2 Mins	0x32	2 Hours
0x03	90 Mins	0x13	3 Secs	0x23	3 Mins	0x33	3 Hours
N/A	N/A	0x14	4 Secs	0x24	4 Mins	0x34	4 Hours
N/A	N/A	0x15	5 Secs	0x25	5 Mins	0x35	5 Hours
N/A	N/A	0x16	6 Secs	0x26	6 Mins	0x36	6 Hours
N/A	N/A	0x17	7 Secs	0x27	7 Mins	0x37	7 Hours
N/A	N/A	0x18	8 Secs	0x28	8 Mins	0x38	8 Hours
N/A	N/A	0x19	9 Secs	0x29	9 Mins	0x39	9 Hours
N/A	N/A	0x1A	10 Secs	0x2A	10 Mins	0x3A	10 Hours
N/A	N/A	0x1B	15 Secs	0x2B	15 Mins	0x3B	15 Hours
N/A	N/A	0x1C	20 Secs	0x2C	20 Mins	0x3C	20 Hours
N/A	N/A	0x1D	30 Secs	0x2D	30 Mins	0x3D	30 Hours
N/A	N/A	0x1E	45 Secs	0x2E	45 Mins	0x3E	45 Hours
N/A	N/A	0x1F	60 Secs	0x2F	60 Mins	0x3F	60 Hours



CAUTION With hardware handshaking disabled, the DS36X8 wakes from low power mode upon receiving a character. However, the DS36X8 does not process this character or any others it receives during the 7 msec period following wakeup. Wait at least 7 msec after wakeup to send valid characters.

Encapsulation of RSM Commands/Responses over SSI

The SSI protocol allows the host to send a command that is variable in length up to 255 bytes. Although there is a provision in the protocol to multi-packet commands from the host, the scan engine does not support this. The host must fragment packets using the provisions in the RSM protocol.

Command Structure

Byte	7	6	5	4	3	2	1	0
0	Length (not including the checksum)							
1	SSI_MGMT_COMMAND (0x80)							
2	Message Source (4 - Host)							
3	Reserved (0)			Reserved (0)		Reserved (0)	Cont'd packet	Retransmit
4	Payload data (see the following example)							
...								
Length -1								
Length	2's complement checksum (MSB)							
Length +1	2's complement checksum (LSB)							

The expected response in the positive case is SSI_MGMT_COMMAND which may be a multi-packet response. For devices that do not support the SSI_MGMT_COMMAND, the response is the standard SSI_NAK.

Response Structure

Byte	7	6	5	4	3	2	1	0
0	Length (not including the checksum)							
1	SSI_MGMT_COMMAND (0x80)							
2	Message Source (0 - Decoder)							
3	Reserved (0)			Reserved (0)		Reserved (0)	Cont'd packet	Retransmit
4	Payload data (see the following example)							
...								
Length -1								
Length	2's complement checksum (MSB)							
Length +1	2's complement checksum (LSB)							

Example Transaction

The following example illustrates how to retrieve diagnostic information (Diagnostic Testing and Reporting (Attribute #10061) decimal) from the engine using encapsulation of RSM commands over SSI. Before sending any RSM command, the host must send the RSM Get Packet Size command to query the packet size supported by the device.

Command from Host to Query Packet Size Supported by Device

```
0A 80 04 00 00 06 20 00 FF FF FD 4E
```

Where:

- 0A 80 04 00 is encapsulation of RSM commands over SSI command header
- 00 06 20 00 FF FF is RSM Get Packet Size command
- FD 4E is SSI command checksum

Response from Device with Packet Size Information

```
0C 80 00 00 00 08 20 00 00 F0 00 F0 FD 6C
```

Where:

- 0C 80 00 00 is encapsulation of RSM command over SSI command header
- 00 08 20 00 00 F0 00 F0 is RSM Get Packet Size response
- FD 6C is SSI response checksum

Command from Host to Retrieve Diagnostic Information

```
0C 80 04 00 00 08 02 00 27 4D 42 00 FE B0
```

Where:

- 0C 80 04 00 is encapsulation of RSM commands over SSI command header
- 00 08 02 00 27 4D 42 00 is attribute Get command requesting attribute 10061 decimal
- FE B0 is SSI command checksum

Response from Device with Diagnostic Information

```
21 80 00 00 00 1D 02 00 27 4D 41 01 42 00 0E 00 00 00 00 01 03 02 03 03 03 04 03 05 03 06 03 FF FF FC 15
```

Where:

- 21 80 00 00 00 1D 02 00 27 4D 41 01 42 00 0E 00 00 is encapsulation of RSM responses over SSI command header
- 00 00 01 03 02 03 03 03 04 03 05 03 06 03 is attribute Get response which includes diagnostic report value
- FF FF is attribute Get response, packet termination
- FC 15 is SSI response checksum

Simple Serial Interface Default Parameters

This section describes how to set up the digital scanner with an SSI host. When using SSI, program the digital scanner via barcode menu or SSI hosts commands.

Throughout the programming barcode menus, asterisks (*) indicate default values.

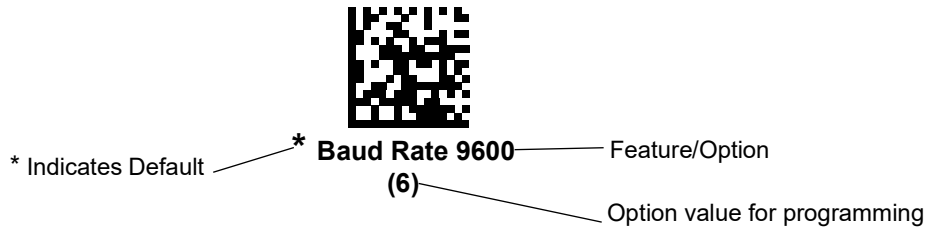

- ✓ **NOTE** Most computer monitors allow scanning the barcodes directly on the screen. When scanning from the screen, be sure to set the document magnification to a level where you can see the barcode clearly, and bars and/or spaces are not merging.

Table 9-3 lists the defaults for the SSI host. There are two ways to change the default values:

- Scan the appropriate barcodes in this guide. These new values replace the standard default values in memory. To recall the default parameter values, scan the ** Restore Defaults* barcode on 6-5.
- Download data through the device's serial port using SSI. Hexadecimal parameter numbers appear in this chapter below the parameter title, and options appear in parenthesis beneath the accompanying barcodes. Refer to the *Simple Serial Interface (SSI) Programmer's Guide* for detailed instructions for changing parameters using this method.

- ✓ **NOTE** See [Appendix A, Standard Default Parameters](#) for all user preferences, hosts, symbologies, and default parameters.

Table 9-3 SSI Default Table

Parameter	Parameter Number	SSI Number	Default	Page Number
Select SSI Host	N/A	N/A	N/A	9-11
Baud Rate	156	9Ch	9600	9-12
Parity	158	9Eh	None	9-13
Check Parity	151	97h	Disable	9-14
Stop Bits	157	9Dh	1	9-15
Software Handshaking	159	9Fh	ACK/NAK	9-16
Host RTS Line State	154	9Ah	Low	9-17
Decode Data Packet Format	238	EEh	Send Raw Decode Data	9-17
Host Serial Response Time-out	155	9Bh	2 Seconds	9-19

Table 9-3 SSI Default Table (Continued)

Parameter	Parameter Number	SSI Number	Default	Page Number
Host Character Time-out	239	EFh	200 msec	9-20
Multipacket Option	334	F0h 4Eh	Option 1	9-21
Interpacket Delay	335	F0h 4Fh	0 msec	9-22
Event Reporting				
Decode Event	256	F0h 00h	Disable	9-23
Boot Up Event	258	F0h 02h	Disable	9-24
Parameter Event	259	F0h 03h	Disable	9-24



NOTE SSI interprets Prefix, Suffix1, and Suffix2 values listed in [Appendix I, ASCII Character Sets](#) differently than other interfaces. SSI does not recognize key categories, only the 3-digit decimal value. The default value of 7013 is interpreted as CR only.

SSI Host Parameters

Select SSI Host

To select SSI as the host interface, scan the following barcode.



SSI Host

Baud Rate

Parameter # 156 (SSI # 9Ch)

Baud rate is the number of bits of data transmitted per second. Set the digital scanner's baud rate to match the baud rate setting of the host device. Otherwise, data may not reach the host device or may reach it in distorted form.



* Baud Rate 9600
(6)



Baud Rate 19,200
(7)



Baud Rate 38,400
(8)



Baud Rate 57,600
(10)

Baud Rate (continued)



**Baud Rate 115,200
(11)**



**Baud Rate 230,400
(13)**



**Baud Rate 460,800
(14)**



**Baud Rate 921,600
(15)**

Parity

Parameter # 158 (SSI # 9Eh)

A parity check bit is the most significant bit of each ASCII coded character. Select the parity type according to host device requirements.

- Select **Odd** parity and the parity bit has a value 0 or 1, based on data, to ensure that an odd number of 1 bits is contained in the coded character.
- Select **Even** parity and the parity bit has a value 0 or 1, based on data, to ensure that an even number of 1 bits is contained in the coded character.

- If no parity is required, select **None**.



**Odd
(2)**



**Even
(1)**



*** None
(0)**

Check Parity

Parameter # 151 (SSI # 97h)

Select whether or not to check the parity of received characters. Use the Parity parameter to select the type of parity.



*** Do Not Check Parity
(0)**



**Check Parity
(1)**

Stop Bits

Parameter # 157 (SSI # 9Dh)

The stop bit(s) at the end of each transmitted character marks the end of transmission of one character and prepares the receiving (host) device for the next character in the serial data stream. Set the number of stop bits (one or two) to match host device requirements.



*** 1 Stop Bit**
(1)



2 Stop Bits
(2)

Software Handshaking

Parameter # 159 (SSI # 9Fh)

This parameter offers control of data transmission in addition to the control hardware handshaking offers. Hardware handshaking is always enabled; you cannot disable it.

- **Disable ACK/NAK Handshaking:** When this option is selected, the digital scanner neither generates nor expects ACK/NAK handshaking packets.
- **Enable ACK/NAK Handshaking:** When this option is selected, after transmitting data, the digital scanner expects either an ACK or NAK response from the host. The digital scanner also ACKs or NAKs messages from the host.

The digital scanner waits up to the programmable Host Serial Response Time-out to receive an ACK or NAK. If the digital scanner does not get a response in this time, it resends its data up to two times before discarding the data and declaring a transmit error.



Disable ACK/NAK
(0)



*** Enable ACK/NAK**
(1)

Host RTS Line State

Parameter # 154 (SSI # 9Ah)

This parameter sets the expected idle state of the Serial Host RTS line.

The SSI Interface is used with host applications which also implement the SSI protocol. However, you can use the digital scanner in a "scan-and-transmit" mode to communicate with any standard serial communication software on a host PC (see [Decode Data Packet Format on page 9-17](#)). If transmission errors occur in this mode, the host PC may be asserting hardware handshaking lines which interfere with the SSI protocol. Scan the **Host: RTS High** barcode to address this problem.



* Host: RTS Low
(0)



Host: RTS High
(1)

Decode Data Packet Format

Parameter # 238 (SSI # EEh)

This parameter selects whether to transmit decoded data in raw format (unpacked), or with the packet format defined by the serial protocol.

Selecting the raw format disables ACK/NAK handshaking for decode data.



*** Send Raw Decode Data**
(0)



Send Packeted Decode Data
(1)

Host Serial Response Time-out

Parameter # 155 (SSI # 9Bh)

This parameter specifies how long the digital scanner waits for an ACK or NAK before resending. Also, if the digital scanner wants to send, and the host has already been granted permission to send, the digital scanner waits for the designated time-out before declaring an error.

To set the delay period (options are 2, 5, 7.5, or 9.9 seconds), scan one of the following barcodes.

✓ **NOTE** Other values are available via SSI command.

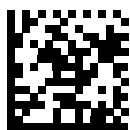

* Low - 2 Seconds
(20)



- 5 Seconds
(50)



High - 7.5 Seconds
(75)



Maximum - 9.9 Seconds
(99)

Host Character Time-out

Parameter # 239 (SSI # EFh)

This parameter determines the maximum time the digital scanner waits between characters transmitted by the host before discarding the received data and declaring an error.

To set the delay period (options are 200, 500, 750, or 990 msec), scan one of the following barcodes.

✓ **NOTE** Other values are available via SSI command.

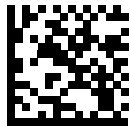

* Low - 200 msec
(20)



Medium - 500 msec
(50)



High - 750 msec
(75)



Maximum - 990 msec
(99)

Multipacket Option

Parameter # 334 (SSI # F0h 4Eh)

This parameter controls ACK/NAK handshaking for multi-packet transmissions.

- **Multi-Packet Option 1:** The host sends an ACK / NAK for each data packet during a multi-packet transmission.
- **Multi-Packet Option 2:** The digital scanner sends data packets continuously, with no ACK/NAK handshaking to pace the transmission. The host, if overrun, can use hardware handshaking to temporarily delay digital scanner transmissions. At the end of transmission, the digital scanner waits for a CMD_ACK or CMD_NAK.
- **Multi-Packet Option 3:** Option 3 is the same as option 2 with the addition of a programmable interpacket delay.



* Multipacket Option 1
(0)



Multipacket Option 2
(1)



Multipacket Option 3
(2)

Interpacket Delay

Parameter # 335 (SSI # F0h 4Fh)

This parameter specifies the interpacket delay if you selected **Multipacket Option 3**.

To set the delay period (options are 0, 25, 50, 75, or 99 msec), scan one of the following barcodes.

✓ **NOTE** Other values are available via SSI command.

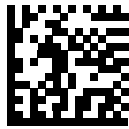

* Minimum - 0 msec
(0)



Low - 25 msec
(25)



Medium - 50 msec
(50)



High - 75 msec
(75)

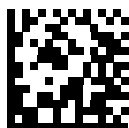

Maximum - 99 msec
(99)

Event Reporting

The host can request the digital scanner to provide certain information (events) relative to the digital scanner's behavior. Enable or disable the events listed in [Table 9-4](#) and on the following pages by scanning the appropriate barcodes.

Table 9-4 *Event Codes*

Event Class	Event	Code Reported
Decode Event	Non parameter decode	0x01
Boot Up Event	System power-up	0x03
Parameter Event	Parameter entry error	0x07
	Parameter stored	0x08
	Defaults set (and parameter event is enabled by default)	0x0A
	Number expected	0x0F

Decode Event

Parameter # 256 (SSI # F0h 00h)

When enabled, the digital scanner generates a message to the host upon a successful barcode decode. When disabled, no notification is sent.



**Enable Decode Event
(1)**



*** Disable Decode Event
(0)**

Boot Up Event

Parameter # 258 (SSI # F0h 02h)

When enabled, the digital scanner generates a message to the host whenever power is applied. When disabled, no notification is sent.



**Enable Boot Up Event
(1)**



*** Disable Boot Up Event
(0)**

Parameter Event

Parameter # 259 (SSI # F0h 03h)

When enabled, the digital scanner generates a message to the host when one of the events specified in [Table 9-4 on page 9-23](#) occurs. When disabled, no notification is sent.

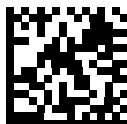

**Enable Parameter Event
(1)**



*** Disable Parameter Event
(0)**

CHAPTER 10 RS-232 INTERFACE

Introduction

This chapter describes how to set up the digital scanner with an RS-232 host. Use the RS-232 interface to connect the digital scanner to point-of-sale devices, host computers, or other devices with an available RS-232 port (e.g., com port).

If your host does not appear in [Table 10-2](#), refer to the documentation for the host device to set communication parameters to match the host.

- ✓ **NOTE** The digital scanner uses TTL RS-232 signal levels, which interface with most system architectures. For system architectures requiring RS-232C signal levels, Zebra offers different cables providing TTL-to-RS-232C conversion. Contact support for more information.

Throughout the programming barcode menus, asterisks (*) indicate default values.



* Indicates default — * **Baud Rate 9600** — Feature/Option

- ✓ **NOTE** Most computer monitors allow scanning the barcodes directly on the screen. When scanning from the screen, be sure to set the document magnification to a level where you can see the barcode clearly, and bars and/or spaces are not merging.

Connecting an RS-232 Interface

Connecting DS3678 to RS-232 Interface

Connect the digital scanner directly to the host computer.

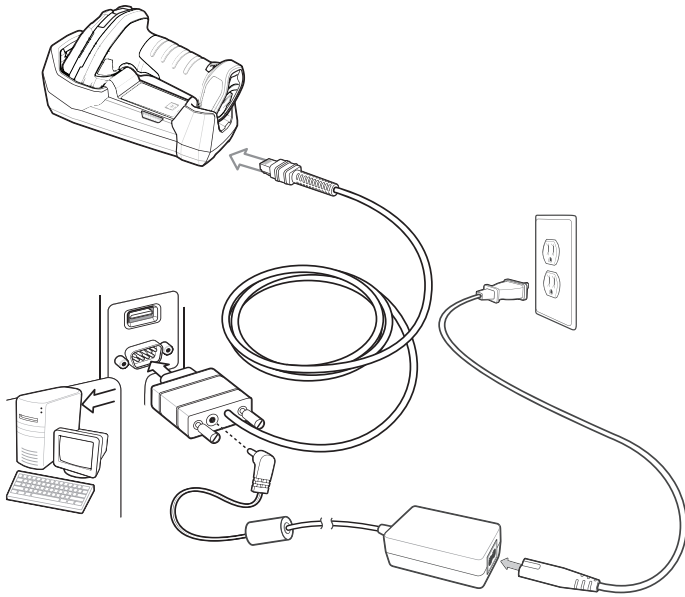

Figure 10-1 RS-232 Direct Connection to DS3678

- ✓ **NOTE** Interface cables vary depending on configuration. The connectors illustrated in [Figure 10-1](#) are examples only. The connectors may be different from those illustrated, but the steps to connect the cradle remain the same.
- ✓ **NOTE** Disconnect the host cables before the power supply, or the digital scanner may not recognize the new host.

To connect the cradle with a RS-232 interface:

1. Connect the other end of the RS-232 interface cable to the serial port on the host.
2. Attach the modular connector of the RS-232 interface cable to the cable interface port on the cradle. See [Connecting the Cradle on page 1-6](#).
3. If required, connect the power supply.
 - ✓ **NOTE** When using the power on pin 9 RS232 cables, ensure that the host the cables are plugged into is supplying 5V only. Some vehicle mounted computers have the option of supplying either 5V or 12V on pin 9. Ensure the option is set to 5V or the cradle will not power up (the cradle does not sustain damage whereas a corded scanner does sustain damage).
4. Ensure that all connections are secure.
5. Pair the digital scanner to the cradle by scanning the barcode on the cradle.
6. Select the RS-232 host type by scanning the appropriate barcode from [RS-232 Host Types on page 10-7](#).
 - ✓ **NOTE** The interface cable automatically detects the host interface type and uses the default setting. If the default (*) does not meet your requirements, scan another host barcode.
7. To modify any other parameter options, scan the appropriate barcodes in this chapter.

Connecting DS3608 to USB Interface

Connect the digital scanner directly to the host computer.

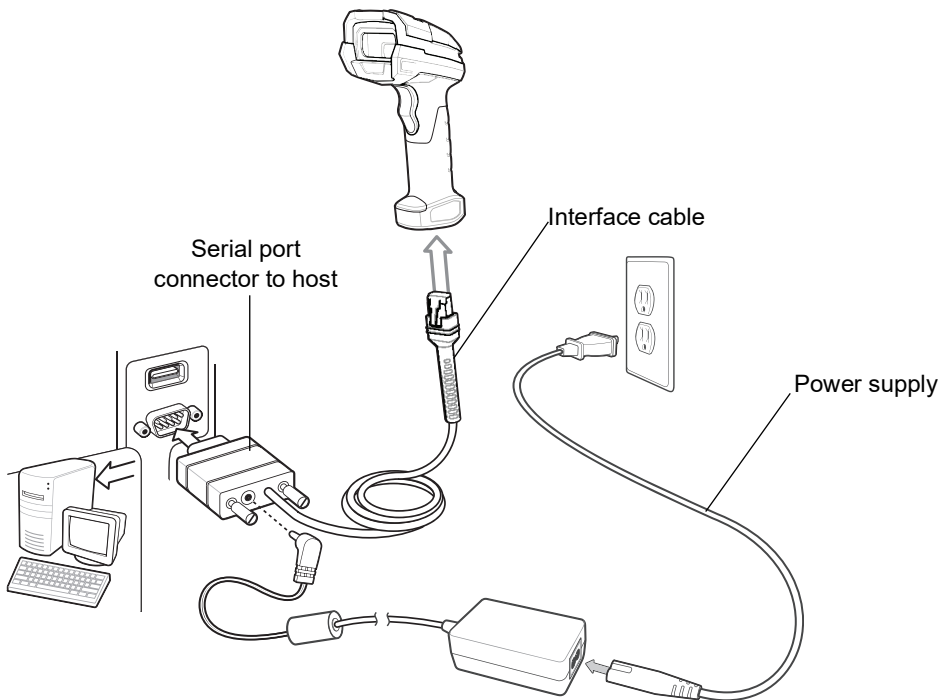

Figure 10-2 RS-232 Direct Connection to DS3608

✓ **NOTE** Interface cables vary depending on configuration. The connectors illustrated in [Figure 10-2](#) are examples only. The connectors may be different than those illustrated, but the steps to connect the digital scanner are the same.

1. Attach the modular connector of the RS-232 interface cable to the cable interface port on the digital scanner (see [Installing the DS3608 Interface Cable on page 1-16](#)).
2. Connect the other end of the RS-232 interface cable to the serial port on the host.
3. Connect the power supply to the serial connector end of the RS-232 interface cable. Plug the power supply into an appropriate outlet.
4. The digital scanner automatically detects the host interface type and uses the default setting. If the default (*) does not meet your requirements, select another RS-232 host type by scanning the appropriate barcode from [RS-232 Host Types on page 10-7](#).
5. To modify any other parameter options, scan the appropriate barcodes in this chapter.

RS-232 Parameter Defaults

[Table 10-1](#) lists the defaults for RS-232 host parameters. To change any option, scan the appropriate barcode(s) provided in the RS-232 Host Parameters section beginning on page [10-5](#).

Table 10-1 *RS-232 Host Default Table*

Parameter	Default	Page Number
RS-232 Host Parameters		
RS-232 Host Types	Standard	10-7
Baud Rate	9600	10-10
Parity Type	None	10-11
Stop Bits	1 Stop Bit	10-12
Data Bits	8-Bit	10-12
Check Receive Errors	Enable	10-13
Hardware Handshaking	None	10-13
Software Handshaking	None	10-15
Host Serial Response Time-out	2 Seconds	10-17
RTS Line State	Low RTS	10-18
Intercharacter Delay	0 msec	10-18
Nixdorf Beep/LED Options	Normal Operation	10-19
Ignore Unknown Characters	Send Bar Code	10-20
Beep on <BEL>	Do Not Beep On <BEL> Character	10-20
Datalogic Host Format	Enable	10-21
Datalogic Supported Commands	Disable	10-22

RS-232 Host Parameters

Various RS-232 hosts use their own parameter default settings. Selecting standard, ICL, Fujitsu, Wincor-Nixdorf Mode A, Wincor-Nixdorf Mode B, OPOS/JPOS, Olivetti, Omron, or Common Use Terminal Equipment (CUTE-LP/LG barcode readers) sets the defaults listed in [Table 10-2](#).

Table 10-2 Terminal Specific RS-232

Parameter	ICL	Fujitsu	Wincor-Nixdorf Mode A	Wincor-Nixdorf Mode B/OPOS/JPOS	Olivetti	Omron	CUTE
Transmit Code ID	Yes	Yes	Yes	Yes	Yes	Yes	Yes
Data Transmission Format	Data/Suffix	Data/Suffix	Data/Suffix	Data/Suffix	Prefix/Data/Suffix	Data/Suffix	Prefix/Data/Suffix
Suffix	CR (1013)	CR (1013)	CR (1013)	CR (1013)	ETX (1002)	CR (1013)	CR (1013) ETX (1003)
Baud Rate	9600	9600	9600	9600	9600	9600	9600
Parity	Even	None	Odd	Odd	Even	None	Even
Hardware Handshaking	RTS/CTS Option 3	None	RTS/CTS Option 3	RTS/CTS Option 3	None	None	None
Software Handshaking	None	None	None	None	ACK/NAK	None	None
Serial Response Time-out	9.9 Sec	2 Sec	None	None	9.9 Sec	9.9 Sec	9.9 Sec
Stop Bit Select	One	One	One	One	One	One	One
ASCII Format	8-Bit	8-Bit	8-Bit	8-Bit	7-Bit	8-Bit	7-Bit
Beep On <BEL>	Disable	Disable	Disable	Disable	Disable	Disable	Disable
RTS Line State	High	Low	Low	Low = No data to send	Low	High	High
Prefix	None	None	None	None	STX (1003)	None	STX (1002)

In the Nixdorf Mode B, if CTS is low, scanning is disabled. When CTS is high, scanning is enabled.

If you scan Nixdorf Mode B without connecting the digital scanner to the proper host, it may appear unable to scan. If this happens, scan a different RS-232 host type within 5 seconds of cycling power to the digital scanner.

The CUTE host disables all parameter scanning, including Set Defaults. If you inadvertently select CUTE, scan * Enable Parameter Bar Code Scanning (1) on page 6-6, then change the host selection.

RS-232 Host Parameters (continued)

Selecting ICL, Fujitsu, Wincor-Nixdorf Mode A, Wincor-Nixdorf Mode B, OPOS/JPOS, Olivetti, Omron, or Common Use Terminal Equipment (CUTE-LP/LG barcode readers) enables the transmission of code ID characters listed in [Table 10-3](#). These code ID characters are not programmable and are separate from the Transmit Code ID feature. Do not enable the Transmit Code ID feature for these terminals.

Table 10-3 Terminal Specific Code ID Characters

Code Type	ICL	Fujitsu	Wincor-Nixdorf Mode A	Wincor-Nixdorf Mode B/ OPOS/JPOS	Olivetti	Omron	CUTE
UPC-A	A	A	A	A	A	A	A
UPC-E	E	E	C	C	C	E	None
EAN-8/JAN-8	FF	FF	B	B	B	FF	None
EAN-13/JAN-13	F	F	A	A	A	F	A
Code 39	C <len>	None	M	M	M <len>	C <len>	3
Code 39 Full ASCII	None	None	M	M	None	None	3
Codabar	N <len>	None	N	N	N <len>	N <len>	None
Code 128	L <len>	None	K	K	K <len>	L <len>	5
I 2 of 5	I <len>	None	I	I	I <len>	I <len>	1
Code 93	None	None	L	L	L <len>	None	None
D 2 of 5	H <len>	None	H	H	H <len>	H <len>	2
GS1-128	L <len>	None	P	P	P <len>	L <len>	5
MSI	None	None	O	O	O <len>	None	None
Bookland EAN	F	F	A	A	A	F	None
Trioptic	None	None	None	None	None	None	None
Code 11	None	None	None	None	None	None	None
IATA	H<len>	None	H	H	H<len>	H<len>	2
Code 32	None	None	None	None	None	None	None
GS1 Databar Variants	None	None	E	E	None	None	None
PDF417	None	None	Q	Q	None	None	6
Data Matrix	None	None	R	R	None	None	4
QR Codes	None	None	U	U	None	None	7
Aztec/Aztec Rune	None	None	V	V	None	None	8
MAXICODE	None	None	T	T	None	None	None
microPDF	None	None	S	S	None	None	6
GS1 Data Matrix	None	None	W	W	None	None	None
QR Codes	None	None	U	U	None	None	7
GS1-QR	None	None	X	X	None	None	None

RS-232 Host Types

To select an RS-232 host interface, scan one of the following barcodes.

✓ **NOTE** For a list of supported scanner functionality by communication protocol, see [Appendix J, Communication Protocol Functionality](#).



* Standard RS-232¹



ICL RS-232



Wincor-Nixdorf RS-232 Mode A



Wincor-Nixdorf RS-232 Mode B

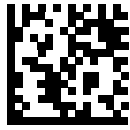

Olivetti ORS4500



Omron

¹Scanning Standard RS-232 activates the RS-232 driver, but does not change port settings (e.g., parity, data bits, handshaking). Selecting another RS-232 host type barcode changes these settings.

RS-232 Host Types (continued)



OPOS/JPOS



Fujitsu RS-232

CUTE ²

Datalogic Variant

²The CUTE host disables all parameter scanning, including Set Defaults. If you inadvertently select CUTE, scan [* Enable Parameter Bar Code Scanning \(1\) on page 6-6](#), then change the host selection.

Baud Rate

Baud rate is the number of bits of data transmitted per second. Set the digital scanner's baud rate to match the baud rate setting of the host device. Otherwise, data may not reach the host device or may reach it in distorted form.



NOTE The digital scanner does not support baud rates below 9600.



* Baud Rate 9600

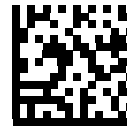

Baud Rate 19,200

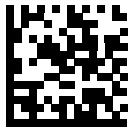

Baud Rate 38,400



Baud Rate 57,600



Baud Rate 115,200

Parity

A parity check bit is the most significant bit of each ASCII coded character. Select the parity type according to host device requirements.

- Select **Odd** parity to set the parity bit value to 0 or 1, based on data, to ensure that the coded character contains an odd number of 1 bits.
- Select **Even** parity to set the parity bit value is set to 0 or 1, based on data, to ensure that the coded character contains an even number of 1 bits.
- Select **None** when no parity bit is required.



Odd



Even



* None

Stop Bit Select

The stop bit(s) at the end of each transmitted character marks the end of transmission of one character and prepares the receiving device for the next character in the serial data stream. Select the number of stop bits (one or two) based on the number the receiving terminal is programmed to accommodate. Set the number of stop bits to match host device requirements.



* 1 Stop Bit



2 Stop Bits

Data Bits

This parameter allows the digital scanner to interface with devices requiring a 7-bit or 8-bit ASCII protocol.



7-Bit



* 8-Bit

Check Receive Errors

Select whether or not to check the parity, framing, and overrun of received characters. The parity value of received characters is verified against the parity parameter selected above.

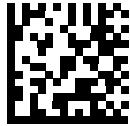

* Check For Received Errors



Do Not Check For Received Errors

Hardware Handshaking

The data interface consists of an RS-232 port designed to operate either with or without the hardware handshaking lines, *Request to Send* (RTS), and *Clear to Send* (CTS).

Disable Standard RTS/CTS handshaking to transmit scan data as it becomes available. Select Standard RTS/CTS handshaking to transmit scan data according to the following sequence:

- The digital scanner reads the CTS line for activity. If CTS is asserted, the scanner waits up to Host Serial Response Time-out for the host to de-assert the CTS line. If, after Host Serial Response Time-out (default), the CTS line is still asserted, the scanner sounds a transmit error, and discards any scanned data.
- When the CTS line is de-asserted, the digital scanner asserts the RTS line and waits up to Host Serial Response Time-out for the host to assert CTS. When the host asserts CTS, the scanner transmits data. If, after Host Serial Response Time-out (default), the CTS line is not asserted, the scanner sounds a transmit error, and discards the data.
- When data transmission completes, the digital scanner de-asserts RTS 10 msec after sending the last character.
- The host should respond by negating CTS. The digital scanner checks for a de-asserted CTS upon the next transmission of data.

During the transmission of data, the CTS line should be asserted. If CTS is deasserted for more than 50 msec between characters, the digital scanner aborts transmission, sounds a transmission error, and discards the data.

If this communication sequence fails, the digital scanner issues an error indication. In this case, the data is lost and must be rescanned.

If hardware handshaking and software handshaking are both enabled, hardware handshaking takes precedence.

✓ **NOTE** The DTR signal is jumpered to the active state.

Hardware Handshaking (continued)

- **None:** Scan this barcode to disable hardware handshaking.
- **Standard RTS/CTS:** Scan this barcode to select Standard RTS/CTS Hardware Handshaking.
- **RTS/CTS Option 1:** If you select RTS/CTS Option 1, the digital scanner asserts RTS before transmitting and ignores the state of CTS. The scanner de-asserts RTS when the transmission completes.
- **RTS/CTS Option 2:** If you select Option 2, RTS is always high or low (user-programmed logic level). However, the digital scanner waits for CTS to be asserted before transmitting data. If CTS is not asserted within Host Serial Response Time-out (default), the scanner issues an error indication and discards the data.
- **RTS/CTS Option 3:** If you select Option 3, the digital scanner asserts RTS prior to any data transmission, regardless of the state of CTS. The scanner waits up to Host Serial Response Time-out (default) for CTS to be asserted. If CTS is not asserted during this time, the scanner issues an error indication and discards the data. The digital scanner de-asserts RTS when transmission is complete.



* None



Standard RTS/CTS



RTS/CTS Option 1



RTS/CTS Option 2



RTS/CTS Option 3

Software Handshaking

This parameter offers control of the data transmission process in addition to, or instead of, that offered by hardware handshaking. There are five options.

If software handshaking and hardware handshaking are both enabled, hardware handshaking takes precedence.

- **None:** Select this to transmit data immediately. The digital scanner expects no response from the host.
- **ACK/NAK:** If you select this option, after transmitting data, the digital scanner expects either an ACK or NAK response from the host. When it receives a NAK, the scanner transmits the same data again and waits for either an ACK or NAK. After three unsuccessful attempts to send data after receiving NAKs, the digital scanner issues an error indication and discards the data.

The digital scanner waits up to the programmable Host Serial Response Time-out to receive an ACK or NAK. If the scanner does not get a response in this time, it issues an error indication and discards the data. There are no retries when a time-out occurs.

- **ENQ:** If you select this option, the digital scanner waits for an ENQ character from the host before transmitting data. If it does not receive an ENQ within the Host Serial Response Time-out, the digital scanner issues an error indication and discards the data. The host must transmit an ENQ character at least every Host Serial Response Time-out to prevent transmission errors.
- **ACK/NAK with ENQ:** This combines the two previous options. For re-transmissions of data, due to a NAK from the host, an additional ENQ is not required.
- **XON/XOFF:** An XOFF character turns the digital scanner transmission off until the scanner receives an XON character. There are two situations for XON/XOFF:
 - The digital scanner receives an XOFF before has data to send. When the scanner has data to send, it waits up to Host Serial Response Time-out for an XON character before transmission. If it does not receive the XON within this time, the digital scanner issues an error indication and discards the data.
 - The digital scanner receives an XOFF during a transmission. Data transmission then stops after sending the current byte. When the digital scanner receives an XON character, it sends the rest of the data message. The digital scanner waits indefinitely for the XON.

Software Handshaking (continued)



* None



ACK/NAK



ENQ



ACK/NAK with ENQ



XON/XOFF

Host Serial Response Time-out

This parameter specifies how long the digital scanner waits for an ACK, NAK, or CTS before determining that a transmission error occurred. This only applies when in one of the ACK/NAK software handshaking modes, or RTS/CTS hardware handshaking mode.



* Minimum: 2 Seconds



Low: 2.5 Seconds



Medium: 5 Seconds



High: 7.5 Seconds



Maximum: 9.9 Seconds

RTS Line State

This parameter sets the idle state of the Serial Host RTS line. Scan a barcode below to select **Low RTS** or **High RTS** line state.



* Host: Low RTS



Host: High RTS

Intercharacter Delay

This parameter specifies the intercharacter delay inserted between character transmissions.



* Minimum: 0 msec



Low: 25 msec



Medium: 50 msec

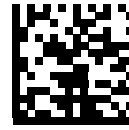

High: 75 msec



Maximum: 99 msec

Nixdorf Beep/LED Options

If you selected Nixdorf Mode B, this indicates when the digital scanner beeps and turns on its LED after a decode.



* Normal Operation
(Beep/LED immediately after decode)



Beep/LED After Transmission



Beep/LED After CTS Pulse

Ignore Unknown Characters

Unknown characters are characters the host does not recognize. Select **Send Bar Codes with Unknown Characters** to send all barcode data except for unknown characters. The digital scanner issues no error beeps.

Select **Do Not Send Bar Codes With Unknown Characters** to send barcode data up to the first unknown character. The digital scanner issues an error beep.



* Send Bar Code
(with unknown characters)



Do Not Send Bar Codes
(with unknown characters)

Beep on <BEL>

If you enable this parameter, the digital scanner issues a beep when it detects a <BEL> character on the RS-232 serial line. <BEL> indicates an illegal entry or other important event.



Beep On <BEL> Character
(Enable)



* Do Not Beep On <BEL> Character
(Disable)

Datalogic Host Format

The following commands are supported over RS-232 or USB CDC.

Parameter # 2253 (SSI # F8 08 CD)

When this parameter is enabled (default), the Datalogic host variant appends a code ID and a suffix value (CR) to the decoded data. When this parameter is disabled, only the decode data is transmitted.

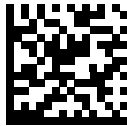

* Enable
(1)



Disable
(0)

Datalogic Supported Commands

Parameter # 2260 (SSI # F8 08 D4)

This parameter allows serial scan to enable or disable commands for a standard RS-232 host.

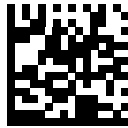

Enable
(1)



* Disable
(0)

- 'E' or 'e' = Enable Scanning
- 'D' or 'd' = Disable Scanning
- 'R' = Reset the scanner
- 'F' = Indicate to the scanner that Datalogic is not on file
- 'B' = Issue a good read beep
- 1 (Not an ASCII Character – This is a decimal number 1) = Force a good read beep
- 7 (Not an ASCII Character – This is a decimal number 7) = Force a good read beep

ASCII Character Set for RS-232

See [Appendix I, ASCII Character Sets](#) for Prefix/Suffix values. The values in [Table I-1](#) can be assigned as prefixes or suffixes for ASCII character data transmission.

CHAPTER 11 IBM INTERFACE

Introduction

This chapter describes how to set up the digital scanner with an IBM 468X/469X host.

Throughout the programming barcode menus, asterisks (*) indicate default values.

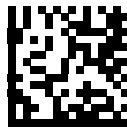

* Indicates default * Disable Convert Unknown to Code 39 Feature/Option

✓ **NOTE** Most computer monitors allow scanning the barcodes directly on the screen. When scanning from the screen, be sure to set the document magnification to a level where you can see the barcode clearly, and bars and/or spaces are not merging.

Connecting to an IBM 468X/469X Host

Connecting DS3678 to an IBM 468X/469X Host

Connect the digital scanner directly to the host interface.

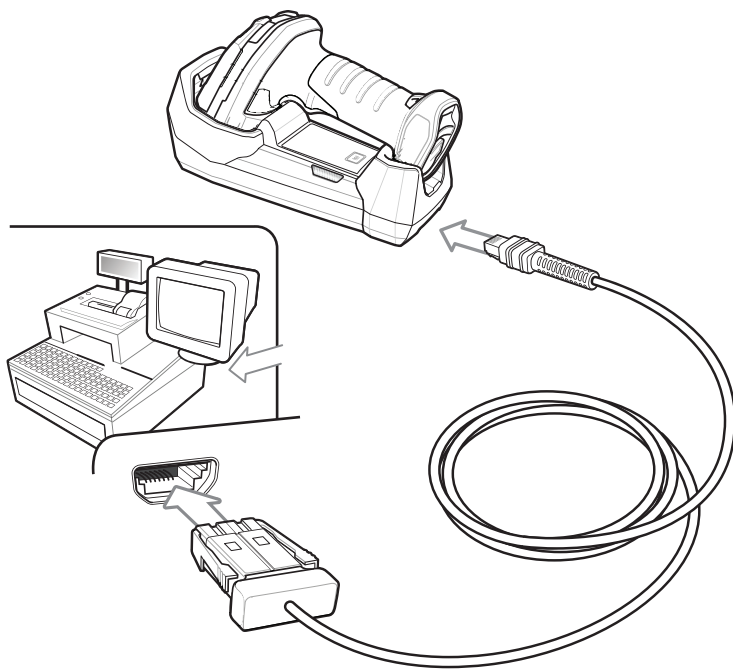

Figure 11-1 IBM Direct Connection to DS3678

- ✓ **NOTE** Interface cables vary depending on configuration. The connectors illustrated in [Figure 11-1](#) are examples only. The connectors may be different from those illustrated, but the steps to connect the cradle remain the same.
 - ✓ **NOTE** Disconnect the host cables before the power supply, or the digital scanner may not recognize the new host.
1. Connect the modular connector of the IBM 46XX interface cable to the cable interface port on the cradle. See [Connecting the Cradle on page 1-6](#).
 2. Connect the other end of the IBM 46XX interface cable to the appropriate port on the host (typically Port 9).
 3. Ensure all connections are secure.
 4. Pair the digital scanner to the cradle by scanning the barcode on the cradle.
 5. Select the port address by scanning the appropriate barcode from [Port Address on page 11-5](#).
 6. To modify other parameter options, scan the appropriate barcodes in this chapter.
- ✓ **NOTE** The only required configuration is the port address. Most other digital scanner parameters are typically controlled by the IBM system.

Connecting DS3608 to an IBM 468X/469X Host

Connect the digital scanner directly to the host interface.

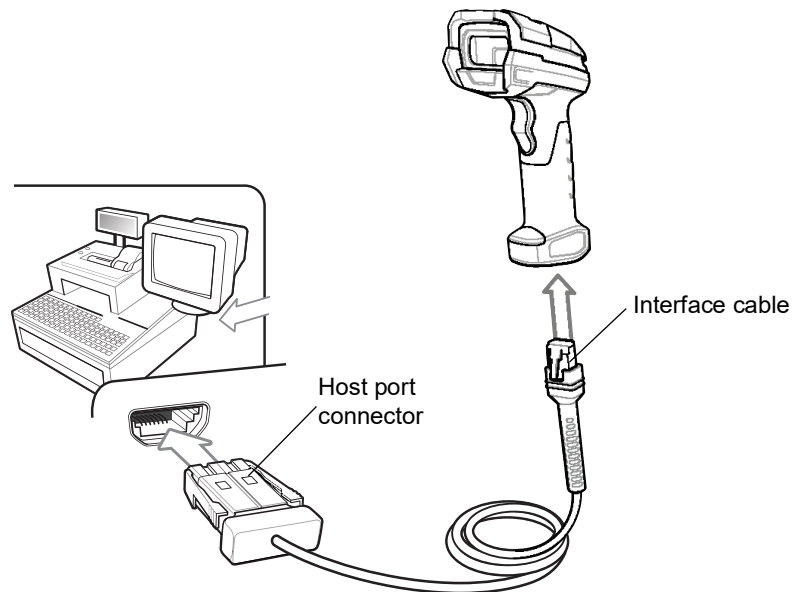

Figure 11-2 IBM Direct Connection to DS3608

✓ **NOTE** Interface cables vary depending on configuration. The connectors illustrated in [Figure 11-2](#) are examples only. The connectors may be different than those illustrated, but the steps to connect the digital scanner are the same.

1. Attach the modular connector of the IBM 46XX interface cable to the cable interface port on the digital scanner. See [Installing the DS3608 Interface Cable on page 1-16](#).
2. Connect the other end of the IBM 46XX interface cable to the appropriate port on the host (typically Port 9).
3. The digital scanner automatically detects the host interface type, but there is no default setting. Scan the port address by scanning the appropriate barcode from [Port Address on page 11-5](#).
4. To modify any other parameter options, scan the appropriate barcodes in this chapter.

✓ **NOTE** The only required configuration is the port address. The IBM system typically controls other digital scanner parameters.

IBM Parameter Defaults

[Table 11-1](#) lists the defaults for IBM host parameters. To change any option, scan the appropriate barcode(s) provided in the Parameter Descriptions section beginning on page [11-5](#).



NOTE See [Appendix A, Standard Default Parameters](#) for all user preferences, hosts, symbologies, and default parameters.

Table 11-1 *IBM Host Default Table*

Parameter	Default	Page Number
IBM 468X/469X Host Parameters		
Port Address	None Selected	11-5
Convert Unknown to Code 39	Disable	11-6
RS-485 Beep Directive	Ignore	11-6
RS-485 Bar Code Configuration Directive	Ignore	11-7
IBM-485 Specification Version	Original Specification	11-7

IBM 468X/469X Host Parameters

Port Address

This parameter sets the IBM 468X/469X port used.

- ✓ **NOTE** Scanning one of these barcodes enables the RS-485 interface on the digital scanner.
- ✓ **NOTE** For a list of supported scanner functionality by communication protocol, see [Appendix J, Communication Protocol Functionality](#).



* None Selected



Hand-held Scanner Emulation (Port 9B)

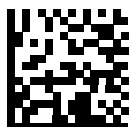

Non-IBM Scanner Emulation (Port 5B)



Table-Top Scanner Emulation (Port 17)

Convert Unknown to Code 39

Scan a barcode below to enable or disable the conversion of unknown barcode type data to Code 39.



Enable Convert Unknown to Code 39



* Disable Convert Unknown to Code 39

RS-485 Beep Directive

The IBM RS-485 host can send a beeper configuration request to the digital scanner. Scan Ignore Beep Directive to prevent the digital scanner from processing the host request. All directives are still acknowledged to the host as if they were processed.



Honor Beep Directive



* Ignore Beep Directive

RS-485 Bar Code Configuration Directive

The IBM RS-485 host can enable and disable code types. Scan Ignore Bar Code Configuration Directive to prevent the digital scanner from processing the host request. All directives are still acknowledged to the IBM RS-485 host as if they were processed.



Honor Bar Code Configuration Directive



* Ignore Bar Code Configuration Directive

IBM-485 Specification Version

Parameter # 1729 (F8h 06h C1h)

Select **IBM-485 Original Specification** to report only symbologies historically supported on each port as known.

Select **IBM-485** to report all symbologies supported in the new IBM specification as known with the respective code types.

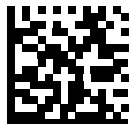

* IBM-485 Original Specification
(0)



IBM-485 (Version 2.2)
(1)

CHAPTER 12 KEYBOARD WEDGE INTERFACE

Introduction

This chapter describes how to set up a keyboard wedge interface with the digital scanner. With this interface, the digital scanner is connected between the keyboard and host computer, and translates barcode data into keystrokes. The host computer accepts the keystrokes as if they originated from the keyboard. This mode adds barcode reading functionality to a system designed for manual keyboard input. Keyboard keystrokes are simply passed through.

Throughout the programming barcode menus, asterisks (*) indicate default values.



*Indicates default * **Send Bar Codes with Unknown Characters** Feature/Option



NOTE Most computer monitors allow scanning the barcodes directly on the screen. When scanning from the screen, be sure to set the document magnification to a level where you can see the barcode clearly, and bars and/or spaces do not merge.

Connecting a Keyboard Wedge Interface

Connecting DS3678 to a Keyboard Wedge Interface

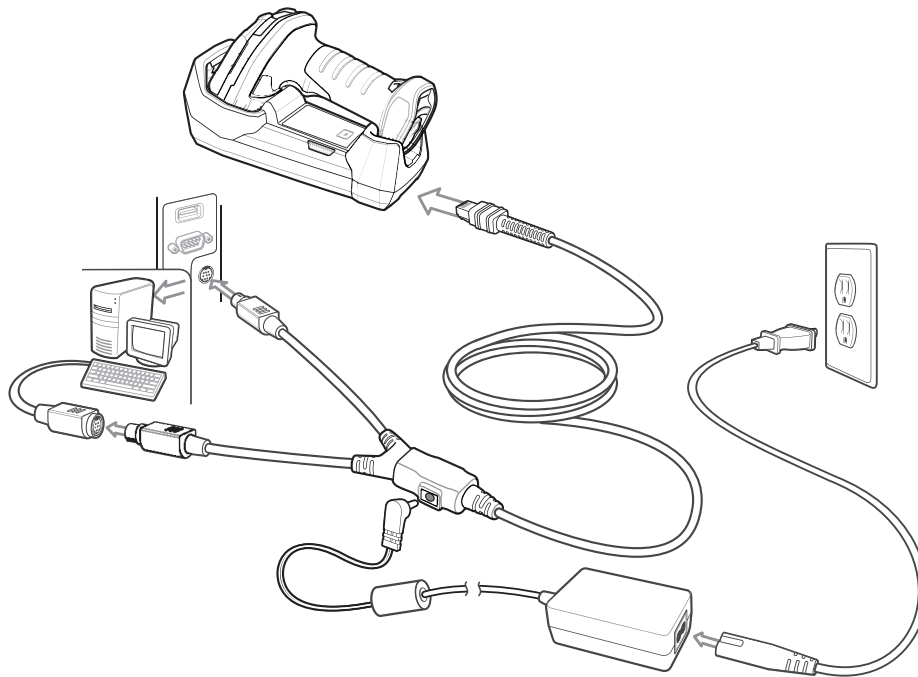

Figure 12-1 Keyboard Wedge Connection to DS3678 with Y-cable

To connect the cordless DS3678 keyboard wedge interface Y-cable:

1. Turn off the host and unplug the keyboard connector.
2. Connect the round male DIN host connector of the Y-cable to the keyboard port on the host.
3. Connect the round female DIN keyboard connector of the Y-cable to the keyboard connector.
4. Attach the modular connector of the Y-cable to the cable interface port on the cradle. See [Connecting the Cradle on page 1-6](#).
5. If required, connect the power supply.
6. Ensure that all connections are secure.
7. Turn on the host system.
8. Pair the digital scanner to the cradle by scanning the barcode on the cradle.
9. Select the keyboard wedge host type by scanning the appropriate barcode from [Keyboard Wedge Host Parameters on page 12-5](#).
10. To modify any other parameter options, scan the appropriate barcodes in this chapter.

✓ **NOTE** Interface cables vary depending on configuration. The connectors illustrated in [Figure 12-1](#) are examples only. The connectors may be different from those illustrated, but the steps to connect the cradle remain the same.

✓ **NOTE** Disconnect the host cables before the power supply, or the digital scanner may not recognize the new host.

Connecting DS3608 to a Keyboard Wedge Interface

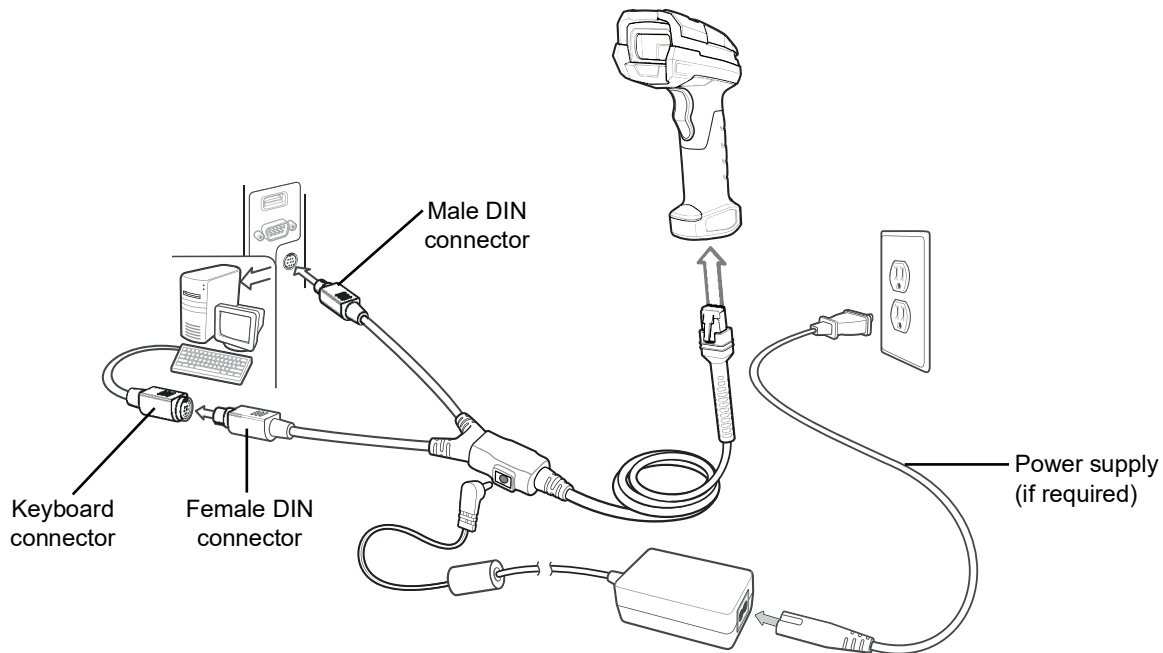

Figure 12-2 Keyboard Wedge Connection to DS3608 with Y-cable

To connect the corded DS3608 to a keyboard wedge interface Y-cable:

✓ **NOTE** Interface cables vary depending on configuration. The connectors illustrated in [Figure 12-2](#) are examples only. The connectors may be different than those illustrated, but the steps to connect the digital scanner are the same.

1. Turn off the host and unplug the keyboard connector.
2. Attach the modular connector of the Y-cable to the cable interface port on the digital scanner. See [Installing the DS3608 Interface Cable on page 1-16](#).
3. Connect the round male DIN host connector of the Y-cable to the keyboard port on the host device.
4. Connect the round female DIN keyboard connector of the Y-cable to the keyboard connector.
5. If needed, attach the optional power supply to the connector in the middle of the Y-cable.
6. Ensure that all connections are secure.
7. Turn on the host system.
8. The digital scanner automatically detects the host interface type and uses the default setting. If the default (*) does not meet your requirements, scan [IBM PC/AT & IBM PC Compatibles on page 12-5](#).
9. To modify any other parameter options, scan the appropriate barcodes in this chapter.

Keyboard Wedge Parameter Defaults

Table 12-1 lists the defaults for Keyboard Wedge host parameters. To change any option, scan the appropriate barcode(s) in *Keyboard Wedge Host Parameters on page 12-5*.



NOTE See *Appendix B, Country Codes* for Keyboard Wedge Country Keyboard Types (Country Codes).

See *Appendix A, Standard Default Parameters* for all user preferences, hosts, symbologies, and default parameters.

Table 12-1 *Keyboard Wedge Host Default Table*

Parameter	Default	Page Number
Keyboard Wedge Host Parameters		
Keyboard Wedge Host Type	IBM AT Notebook	12-5
Ignore Unknown Characters	Transmit	12-5
Keystroke Delay	No Delay	12-6
Intra-Keystroke Delay	Disable	12-6
Alternate Numeric Keypad Emulation	Enable	12-7
Quick Keypad Emulation	Enable	12-7
Simulated Caps Lock	Disable	12-8
Caps Lock Override	Disable	12-8
Convert Wedge Case	No Convert	12-9
Function Key Mapping	Disable	12-9
FN1 Substitution	Disable	12-10
Send Make and Break	Send Make and Break Scan Codes	12-10

Keyboard Wedge Host Parameters

Keyboard Wedge Host Types

Select the Keyboard Wedge host by scanning one of the barcodes below.



NOTE For a list of supported scanner functionality by communication protocol, see [Appendix J, Communication Protocol Functionality](#).



IBM PC/AT & IBM PC Compatibles



* IBM AT Notebook

Ignore Unknown Characters

Unknown characters are characters the host does not recognize. Select **Send Bar Codes With Unknown Characters** to send all barcode data except for unknown characters. The digital scanner issues no error beeps.

Select **Do Not Send Bar Codes With Unknown Characters** to send barcode data up to the first unknown character. The digital scanner issues an error beep.



* Send Bar Codes with Unknown Characters
(Transmit)



Do Not Send Bar Codes with Unknown Characters

Keystroke Delay

This is the delay in milliseconds between emulated keystrokes. Scan a barcode below to increase the delay when hosts require a slower transmission of data.



* No Delay



Medium Delay (20 msec)



Long Delay (40 msec)

Intra-Keystroke Delay

Enable this to insert an additional delay between each emulated key depression and release. This sets the Keystroke Delay parameter to a minimum of 5 msec as well.

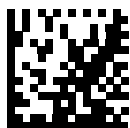

Enable



* Disable

Alternate Numeric Keypad Emulation

This allows emulation of most other country keyboard types not listed in [Appendix B, Country Codes](#) in a Microsoft® operating system environment.

- ✓ **NOTE** If your keyboard type is not listed in the country code list (see [Country Codes on page B-1](#)), disable [Quick Keypad Emulation on page 12-7](#) and ensure [Alternate Numeric Keypad Emulation on page 12-7](#) is enabled.



*Enable Alternate Numeric Keypad



Disable Alternate Numeric Keypad

Quick Keypad Emulation

This parameter enables faster keypad emulation where character value sequences are only sent for characters not found on the keyboard.

- ✓ **NOTE** This option applies only when [Alternate Numeric Keypad Emulation](#) is enabled.



* Enable Quick Keypad Emulation



Disable Quick Keypad Emulation

Simulated Caps Lock

Enable this to invert upper and lower case characters on the barcode as if the Caps Lock state is enabled on the keyboard. This inversion occurs regardless of the keyboard's **Caps Lock** state. Note that this only applies to alpha characters.

✓ **NOTE** Simulated Caps Lock applies to ASCII characters only.



Enable Caps Lock On



* Disable Caps Lock On

Caps Lock Override

Enable this on AT or AT Notebook hosts to preserve the case of the data regardless of the state of the **Caps Lock** key. Therefore, an 'A' in the barcode transmits as an 'A' regardless of the setting of the keyboard's **Caps Lock** key.



Enable Caps Lock Override



* Disable Caps Lock Override

✓ **NOTE** If both Simulated Caps Lock and Caps Lock Override are enabled, Caps Lock Override takes precedence.

Convert Wedge Case

Enable this to convert all barcode data to the selected case.

✓ **NOTE** Convert Case applies to ASCII characters only.



Convert to Upper Case



Convert to Lower Case



* No Convert

Function Key Mapping

ASCII values under 32 are normally sent as control key sequences (see [ASCII Character Sets on page I-1](#)). Enable this parameter to send the keys in bold in place of the standard key mapping. Table entries that do not have a bold entry remain the same whether or not you enable this parameter.



Enable



* Disable

FN1 Substitution

Enable this to replace FN1 characters in an EAN128 barcode with a user-selected keystroke (see [FN1 Substitution Values on page 6-45](#)).



Enable



* Disable

Send Make and Break

Enable this to prevent sending the scan codes for releasing a key.



* Send Make and Break Scan Codes



Send Make Scan Code Only



NOTE Windows-based systems must use **Send Make and Break Scan Codes**.

Keyboard Maps

Refer to the following keyboard maps for prefix/suffix keystroke parameters. To program the prefix/suffix values, see the barcodes on [page 12-11](#).

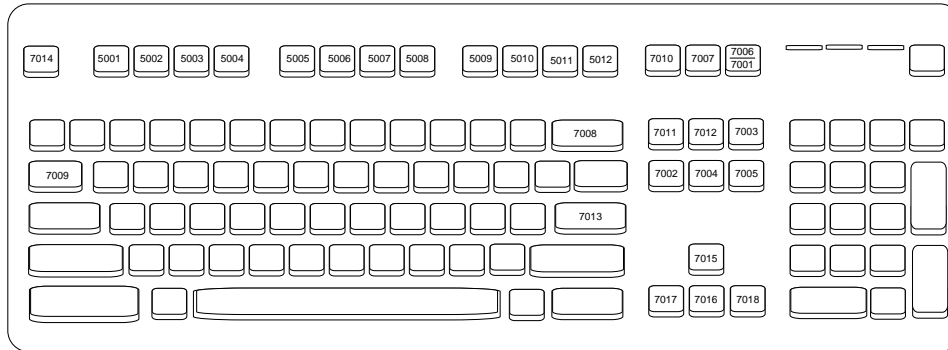

Figure 12-3 IBM PS2 Type Keyboard

ASCII Character Set for Keyboard Wedge

✓ **NOTE** Code 39 Full ASCII interprets the barcode special character (\$ + % /) preceding a Code 39 character and assigns an ASCII character value to the pair. For example, if you enable Code 39 Full ASCII and scan **+B**, it transmits as **b**, **%J** as **?**, and **%V** as **@**. Scanning **ABC%I** outputs the keystroke equivalent of **ABC >**.

See [Appendix I, ASCII Character Sets](#) for the following:

- ASCII Character Set ([Table I-1 on page I-1](#))
- ALT Key Character Set ([Table I-2 on page I-6](#))
- GUI Key Character Set ([Table I-3 on page I-7](#))
- F Key Character Set ([Table I-5 on page I-11](#)).
- Numeric Key Character Set ([Table I-6 on page I-12](#))
- Extended Key Character Set ([Table I-7 on page I-13](#)).

CHAPTER 13 SYMBOLOGIES

Introduction

This chapter describes symbology features and provides programming barcodes for selecting these features. Before programming, follow the instructions in [Chapter 1, Getting Started](#).

To set feature values, scan a single barcode or a short barcode sequence. The settings are stored in non-volatile memory and are preserved even when the digital scanner powers down.

✓ **NOTE** Most computer monitors allow scanning the barcodes directly on the screen. When scanning from the screen, be sure to set the document magnification to a level where you can see the barcode clearly, and bars and/or spaces do not merge.

Select a host type (see each host chapter for specific host information) after the power-up beeps sound. This is only necessary upon the first power-up when connected to a new host.

To return all features to default values, see [Default Parameters on page 6-5](#). Throughout the programming barcode menus, asterisks (*) indicate default values.

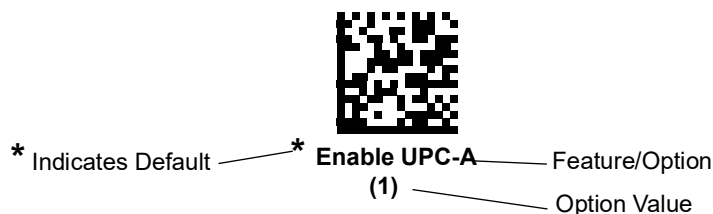

Scanning Sequence Examples

In most cases, scanning one barcode sets the parameter value. For example, to transmit barcode data without the UPC-A check digit, simply scan the **Do Not Transmit UPC-A Check Digit** barcode under [Transmit UPC-A Check Digit on page 13-17](#). The digital scanner issues a fast warble beep and the LED turns green, signifying a successful parameter entry.

Other parameters, such as **Set Length(s) for D 2 of 5** require scanning several barcodes. See the individual parameter, such as **Set Length(s) for D 2 of 5**, for this procedure.

Errors While Scanning

Unless otherwise specified, to correct an error during a scanning sequence, just re-scan the correct parameter.

Symbology Parameter Defaults

[Table 13-1](#) lists the defaults for all symbology parameters. To change the default values, scan the appropriate barcodes in this guide. These new values replace the standard default values in memory. To recall the default parameter values, see [Default Parameters on page 6-5](#).



NOTE See [Appendix A, Standard Default Parameters](#) for all user preferences, hosts, and default parameters.

Table 13-1 Symbology Parameter Defaults

Parameter	Parameter Number	SSI Number	Default	Page Number
Enable/Disable All Code Types				13-8
1D Symbologies				
UPC/EAN				
UPC-A	1	01h	Enable	13-9
UPC-E	2	02h	Enable	13-9
UPC-E1	12	0Ch	Disable	13-10
EAN-8/JAN 8	4	04h	Enable	13-10
EAN-13/JAN 13	3	03h	Enable	13-11
Bookland EAN	83	53h	Disable	13-11
Decode UPC/EAN/JAN Supplementals (2 and 5 digits)	16	10h	Ignore	13-13
User-Programmable Supplementals			000	13-15
Supplemental 1:	579	F1h 43h		
Supplemental 2:	580	F1h 44h		
UPC/EAN/JAN Supplemental Redundancy	80	50h	10	13-15
Decode UPC/EAN/JAN Supplemental AIM ID	672	F1h A0h	Combined	13-16
UPC Reduced Quiet Zone	1289	F8h 05h 09h	Disable	13-17
Transmit UPC-A Check Digit	40	28h	Enable	13-17
Transmit UPC-E Check Digit	41	29h	Enable	13-18
Transmit UPC-E1 Check Digit	42	2Ah	Enable	13-18

Table 13-1 Symbology Parameter Defaults (Continued)

Parameter	Parameter Number	SSI Number	Default	Page Number
UPC-A Preamble	34	22h	System Character	13-19
UPC-E Preamble	35	23h	System Character	13-20
UPC-E1 Preamble	36	24h	System Character	13-21
Convert UPC-E to A	37	25h	Disable	13-22
Convert UPC-E1 to A	38	26h	Disable	13-22
EAN-8/JAN-8 Extend	39	27h	Disable	13-23
Bookland ISBN Format	576	F1h 40h	ISBN-10	13-23
UCC Coupon Extended Code	85	55h	Disable	13-24
Coupon Report	730	F1h DAh	New Coupon Format	13-25
ISSN EAN	617	F1h 69h	Disable	13-25
Code 128				
Code 128	8	08h	Enable	13-26
Set Length(s) for Code 128	209, 210	D1h, D2h	1 to 55	13-27
GS1-128 (formerly UCC/EAN-128)	14	0Eh	Enable	13-29
ISBT 128	84	54h	Disable	13-29
ISBT Concatenation	577	F1h 41h	Autodiscriminate	13-30
Check ISBT Table	578	F1h 42h	Enable	13-31
ISBT Concatenation Redundancy	223	DFh	10	13-31
Code 128 Security Level	751	F1h EFh	Security Level 1	13-32
Code 128 Reduced Quiet Zone	1208	F8h 04h B8h	Disable	13-33
Ignore Code 128 <FNC4>	1254	F8h 04h E6h	Disable	13-33
Code 39				
Code 39	0	00h	Enable	13-34
Trioptic Code 39	13	0Dh	Disable	13-34
Convert Code 39 to Code 32 (Italian Pharmacy Code)	86	56h	Disable	13-35
Code 32 Prefix	231	E7h	Disable	13-35
Set Length(s) for Code 39	18, 19	12h, 13h	1 to 55	13-36
Code 39 Check Digit Verification	48	30h	Disable	13-37
Transmit Code 39 Check Digit	43	2Bh	Disable	13-37

Table 13-1 Symbology Parameter Defaults (Continued)

Parameter	Parameter Number	SSI Number	Default	Page Number
Code 39 Full ASCII Conversion	17	11h	Disable	13-38
Code 39 Security Level	750	F1h EEh	Security Level 1	13-39
Code 39 Reduced Quiet Zone	1209	F8h 04h B9h	Disable	13-40
Code 93				
Code 93	9	09h	Enable	13-40
Set Length(s) for Code 93	26, 27	1Ah, 1Bh	1 to 55	13-41
Code 11				
Code 11	10	0Ah	Disable	13-42
Set Lengths for Code 11	28, 29	1Ch, 1Dh	4 to 55	13-43
Code 11 Check Digit Verification	52	34h	Disable	13-44
Transmit Code 11 Check Digit(s)	47	2Fh	Disable	13-45
Interleaved 2 of 5 (ITF)				
Interleaved 2 of 5 (ITF)	6	06h	Disable	13-45
Set Lengths for I 2 of 5	22, 23	16h, 17h	6 to 55	13-46
I 2 of 5 Check Digit Verification	49	31h	Disable	13-47
Transmit I 2 of 5 Check Digit	44	2Ch	Disable	13-48
Convert I 2 of 5 to EAN 13	82	52h	Disable	13-48
I 2 of 5 Security Level	1121	F8h 04h 61h	Security Level 1	13-49
I 2 of 5 Reduced Quiet Zone	1210	F8h 04h BAh	Disable	13-50
Discrete 2 of 5 (DTF)				
Discrete 2 of 5	5	05h	Disable	13-50
Set Length(s) for D 2 of 5	20, 21	14h 15h	1 to 55	13-51
Codabar (NW - 7)				
Codabar	7	07h	Enable	13-52
Set Lengths for Codabar	24, 25	18h, 19h	4 to 55	13-53
CLSI Editing	54	36h	Disable	13-55
NOTIS Editing	55	37h	Disable	13-55
Codabar Security Level	1776	F8h 06h F0h	Security Level 1	13-56
Codabar Upper or Lower Case Start/ Stop Characters Detection	855	F2h 57h	Upper Case	13-58

Table 13-1 Symbology Parameter Defaults (Continued)

Parameter	Parameter Number	SSI Number	Default	Page Number
Codabar Mod 16 Check Digit Verification	1784	F8h 06h F8h	Disable	13-58
Transmit Codabar Check Digit	704	F1h C0h	Disable	13-59
MSI				
MSI	11	0Bh	Disable	13-60
Set Length(s) for MSI	30, 31	1Eh, 1Fh	4 to 55	13-61
MSI Check Digits	50	32h	One	13-62
Transmit MSI Check Digit	46	2Eh	Disable	13-63
MSI Check Digit Algorithm	51	33h	Mod 10/Mod 10	13-64
MSI Reduced Quiet Zone	1392	F8h 05h 70h	Disable	13-64
Chinese 2 of 5				
Chinese 2 of 5	408	F0h 98h	Disable	13-65
Matrix 2 of 5				
Matrix 2 of 5	618	F1h 6Ah	Disable	13-66
Matrix 2 of 5 Lengths	619 620	F1h 6Bh F1h 6Ch	4 to 55	13-67
Matrix 2 of 5 Check Digit	622	F1h 6Eh	Disable	13-68
Transmit Matrix 2 of 5 Check Digit	623	F1h 6Fh	Disable	13-68
Korean 3 of 5				
Korean 3 of 5	581	F1h 45h	Disable	13-69
Inverse 1D	586	F1h 4Ah	Regular	13-70
GS1 DataBar				
GS1 DataBar-14	338	F0h 52h	Enable	13-71
GS1 DataBar Limited	339	F0h 53h	Enable	13-71
GS1 DataBar Expanded	340	F0h 54h	Enable	13-72
Convert GS1 DataBar to UPC/EAN	397	F0h 8Dh	Disable	13-72
GS1 DataBar Security Level	1706	F8h 06h AAh	Level 1	13-73
GS1 DataBar Limited Margin Check	728	F1h D8h	Level 3	13-74
Composite				
Composite CC-C	341	F0h 55h	Disable	13-75
Composite CC-A/B	342	F0h 56h	Disable	13-75

Table 13-1 Symbology Parameter Defaults (Continued)

Parameter	Parameter Number	SSI Number	Default	Page Number
Composite TLC-39	371	F0h 73h	Disable	13-76
Composite Inverse	1113	F8h 04h 59h	Regular	13-77
UPC Composite Mode	344	F0h 58h	UPC Never Linked	13-78
Composite Beep Mode	398	F0h 8Eh	Beep As Each Code Type is Decoded	13-79
GS1-128 Emulation Mode for UCC/EAN Composite Codes	427	F0h ABh	Disable	13-79
2D Symbologies				
PDF417	15	0Fh	Enable	13-80
MicroPDF417	227	E3h	Disable	13-80
Code 128 Emulation	123	7Bh	Disable	13-81
Data Matrix	292	F0h 24h	Enable	13-82
GS1 Data Matrix	1336	F8h 05h 38h	Disable	13-82
Data Matrix Inverse	588	F1h 4Ch	Inverse Autodetect	13-83
Maxicode	294	F0h 26h	Disable	13-84
QR Code	293	F0h 25h	Enable	13-84
GS1 QR	1343	F8h 05h 3Fh	Disable	13-84
MicroQR	573	F1h 3Dh	Enable	13-85
Linked QR Mode	1847	737h	Linked QR Only	13-86
Aztec	574	F1h 3Eh	Enable	13-87
Aztec Inverse	589	F1h 4Dh	Inverse Autodetect	13-88
Han Xin	1167	F8h 04h 8Fh	Disable	13-89
Han Xin Inverse	1168	F8h 04h 90h	Regular	13-89
Grid Matrix	1718	F8h 06h B6h	Disable	13-90
Grid Matrix Inverse	1719	F8h 06h B7h	Regular	13-91
Grid Matrix Mirrored	1736	F8h 06h C8h	Non-Mirrored	13-92
DotCode	1906	F8 07 72h	Disable	13-93
DotCode Inverse	1907	F8 07 73h	Autodetect	13-94
DotCode Mirrored	1908	F8 07 74h	Autodetect	13-95
DotCode Prioritize	1937	F8 07 91h	Disable	13-96
Postal Codes				

Table 13-1 Symbology Parameter Defaults (Continued)

Parameter	Parameter Number	SSI Number	Default	Page Number
US Postnet	89	59h	Disable	13-97
US Planet	90	5Ah	Disable	13-97
Transmit US Postal Check Digit	95	5Fh	Enable	13-98
UK Postal	91	5Bh	Disable	13-98
Transmit UK Postal Check Digit	96	60h	Enable	13-99
Japan Postal	290	F0h 22h	Disable	13-99
Australia Post	291	F0h 23h	Disable	13-100
Australia Post Format	718	F1h CEh	Autodiscriminate	13-101
Netherlands KIX Code	326	F0h 46h	Disable	13-102
USPS 4CB/One Code/Intelligent Mail	592	F1h 50h	Disable	13-102
UPU FICS Postal	611	F1h 63h	Disable	13-103
Mailmark	1337	F8h 05h 39h	Disable	13-103
Symbology-Specific Security Levels				
Redundancy Level	78	4Eh	1	13-104
Security Level	77	4Dh	1	13-106
1D Quiet Zone Level	1288	F8h 05h 08h	1	13-107
Intercharacter Gap Size	381	F0h 7Dh	Normal	13-108
Report Version				13-108
Macro PDF				
Flush Macro PDF Buffer	N/A	N/A	N/A	13-109
Abort Macro PDF Entry	N/A	N/A	N/A	13-109

Enable/Disable All Code Types

To disable all symbologies, scan **Disable All Code Types** below. This is useful when enabling only a few code types.

Scan **Enable All Code Types** turn on (enable) all code types. This is useful when you want to read all codes, or when you want to disable only a few code types.

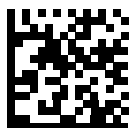

Disable All Code Types



Enable All Code Types

UPC/EAN

Enable/Disable UPC-A

Parameter # 1 (SSI # 01h)

To enable or disable UPC-A, scan the appropriate barcode below.



* Enable UPC-A
(1)



Disable UPC-A
(0)

Enable/Disable UPC-E

Parameter # 2 (SSI # 02h)

To enable or disable UPC-E, scan the appropriate barcode below.

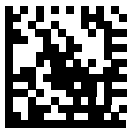

* Enable UPC-E
(1)



Disable UPC-E
(0)

Enable/Disable UPC-E1

Parameter # 12 (SSI # 0Ch)

UPC-E1 is disabled by default.

To enable or disable UPC-E1, scan the appropriate barcode below.

✓ **NOTE** UPC-E1 is not a UCC (Uniform Code Council) approved symbology.



Enable UPC-E1
(1)



* Disable UPC-E1
(0)

Enable/Disable EAN-8/JAN-8

Parameter # 4 (SSI # 04h)

To enable or disable EAN-8/JAN-8, scan the appropriate barcode below.

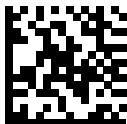

* Enable EAN-8/JAN-8
(1)



Disable EAN-8/JAN-8
(0)

Enable/Disable EAN-13/JAN-13

Parameter # 3 (SSI # 03h)

To enable or disable EAN-13/JAN-13, scan the appropriate barcode below.



* Enable EAN-13/JAN-13
(1)



Disable EAN-13/JAN-13
(0)

Enable/Disable Bookland EAN

Parameter # 83 (SSI # 53h)

To enable or disable Bookland EAN, scan the appropriate barcode below.



Enable Bookland EAN
(1)



* Disable Bookland EAN
(0)



NOTE If you enable Bookland EAN, select a [Bookland ISBN Format on page 13-23](#). Also select either Decode UPC/EAN Supplementals, Autodiscriminate UPC/EAN Supplementals, or Enable 978/979 Supplemental Mode in [Decode UPC/EAN/JAN Supplementals on page 13-12](#).

Decode UPC/EAN/JAN Supplementals

Parameter # 16 (SSI # 10h)

Supplementals are barcodes appended according to specific format conventions (e.g., UPC A+2, UPC E+2, EAN 13+2). The following options are available:

- If you select **Ignore UPC/EAN with Supplementals**, and the digital scanner is presented with a UPC/EAN plus supplemental symbol, the digital scanner decodes UPC/EAN and ignores the supplemental characters.
- If you select **Decode UPC/EAN with Supplementals**, the digital scanner only decodes UPC/EAN symbols with supplemental characters, and ignores symbols without supplementals.
- If you select **Autodiscriminate UPC/EAN Supplementals**, the digital scanner decodes UPC/EAN symbols with supplemental characters immediately. If the symbol does not have a supplemental, the digital scanner must decode the barcode the number of times set via [UPC/EAN/JAN Supplemental Redundancy on page 13-15](#) before transmitting its data to confirm that there is no supplemental.
- If you select one of the following **Supplemental Mode** options, the digital scanner immediately transmits EAN-13 barcodes starting with that prefix that have supplemental characters. If the symbol does not have a supplemental, the digital scanner must decode the barcode the number of times set via [UPC/EAN/JAN Supplemental Redundancy on page 13-15](#) before transmitting its data to confirm that there is no supplemental. The digital scanner transmits UPC/EAN barcodes that do not have that prefix immediately.
 - **Enable 378/379 Supplemental Mode**
 - **Enable 978/979 Supplemental Mode**

✓ **NOTE** If you select 978/979 Supplemental Mode and are scanning Bookland EAN barcodes, see [Enable/Disable Bookland EAN on page 13-11](#) to enable Bookland EAN, and select a format using [Bookland ISBN Format on page 13-23](#).

- **Enable 977 Supplemental Mode**
- **Enable 414/419/434/439 Supplemental Mode**
- **Enable 491 Supplemental Mode**
- **Enable Smart Supplemental Mode** - applies to EAN-13 barcodes starting with any prefix listed previously.
- **Supplemental User-Programmable Type 1** - applies to EAN-13 barcodes starting with a 3-digit user-defined prefix. Set this 3-digit prefix using [User-Programmable Supplementals on page 13-15](#).
- **Supplemental User-Programmable Type 1 and 2** - applies to EAN-13 barcodes starting with either of two 3-digit user-defined prefixes. Set the 3-digit prefixes using [User-Programmable Supplementals on page 13-15](#).
- **Smart Supplemental Plus User-Programmable 1** - applies to EAN-13 barcodes starting with any prefix listed previously or the user-defined prefix set using [User-Programmable Supplementals on page 13-15](#).
- **Smart Supplemental Plus User-Programmable 1 and 2** - applies to EAN-13 barcodes starting with any prefix listed previously or one of the two user-defined prefixes set using [User-Programmable Supplementals on page 13-15](#).

✓ **NOTE** To minimize the risk of invalid data transmission, select either to decode or ignore supplemental characters.

Decode UPC/EAN/JAN Supplementals (continued)



Decode UPC/EAN/JAN Only With Supplementals
(1)

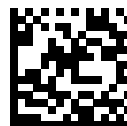

* Ignore Supplementals
(0)



Autodiscriminate UPC/EAN/JAN Supplementals
(2)

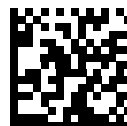

Enable 378/379 Supplemental Mode
(4)

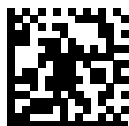

Enable 978/979 Supplemental Mode
(5)

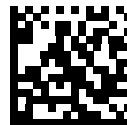

Enable 977 Supplemental Mode
(7)

Decode UPC/EAN/JAN Supplementals (continued)



**Enable 414/419/434/439 Supplemental Mode
(6)**



**Enable 491 Supplemental Mode
(8)**



**Enable Smart Supplemental Mode
(3)**



**Supplemental User-Programmable Type 1
(9)**



**Supplemental User-Programmable Type 1 and 2
(10)**



**Smart Supplemental Plus User-Programmable 1
(11)**



**Smart Supplemental Plus User-Programmable 1 and 2
(12)**

User-Programmable Supplementals

Supplemental 1: Parameter # 579 (SSI # F1h 43h)

Supplemental 2: Parameter # 580 (SSI # F1h 44h)

If you selected a Supplemental User-Programmable option from [Decode UPC/EAN/JAN Supplementals on page 13-12](#), select **User-Programmable Supplemental 1** to set the 3-digit prefix. Then select the 3 digits using the numeric barcodes beginning on [page H-1](#). Select **User-Programmable Supplemental 2** to set a second 3-digit prefix. Then select the 3 digits using the numeric barcodes beginning on [page H-1](#). The default is 000 (zeroes).



User-Programmable Supplemental 1

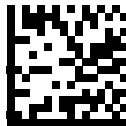

User-Programmable Supplemental 2

UPC/EAN/JAN Supplemental Redundancy

Parameter # 80 (SSI # 50h)

If you selected **Autodiscriminate UPC/EAN/JAN Supplementals**, this option adjusts the number of times to decode a symbol without supplementals before transmission. The range is from two to thirty times. Five or above is recommended when decoding a mix of UPC/EAN/JAN symbols with and without supplementals. The default is 10.

Scan the barcode below to set a decode redundancy value. Next, scan two numeric barcodes in [Appendix H, Numeric Bar Codes](#). Enter a leading zero for single digit numbers. To correct an error or change a selection, scan [Cancel on page H-2](#).

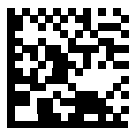

UPC/EAN/JAN Supplemental Redundancy

UPC/EAN/JAN Supplemental AIM ID Format

Parameter # 672 (SSI # F1h A0h)

Select an output format when reporting UPC/EAN/JAN barcodes with Supplementals with *Transmit Code ID Character* on page 6-42 set to **AIM Code ID Character**:

- **Separate** - transmit UPC/EAN with supplementals with separate AIM IDs but one transmission, i.e.:
]E<0 or 4><data>]E<1 or 2>[supplemental data]
- **Combined** – transmit UPC/EAN with supplementals with one AIM ID and one transmission, i.e.:
]E3<data+supplemental data>
- **Separate Transmissions** - transmit UPC/EAN with supplementals with separate AIM IDs and separate transmissions, i.e.:
]E<0 or 4><data>
]E<1 or 2>[supplemental data]

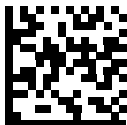

**Separate
(0)**



*** Combined
(1)**



**Separate Transmissions
(2)**

UPC Reduced Quiet Zone

Parameter # 1289 (SSI # F8h 05h 09h)

Scan one of the following barcodes to enable or disable decoding UPC barcodes with reduced quiet zones. If you select **Enable**, select a [1D Quiet Zone Level on page 13-107](#).

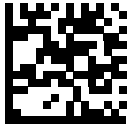

Enable UPC Reduced Quiet Zone
(1)



*** Disable UPC Reduced Quiet Zone**
(0)

Transmit UPC-A Check Digit

Parameter # 40 (SSI # 28h)

The check digit is the last character of the symbol used to verify the integrity of the data. Scan the appropriate barcode below to transmit the barcode data with or without the UPC-A check digit. It is always verified to guarantee the integrity of the data.



*** Transmit UPC-A Check Digit**
(1)



Do Not Transmit UPC-A Check Digit
(0)

Transmit UPC-E Check Digit

Parameter # 41 (SSI # 29h)

The check digit is the last character of the symbol used to verify the integrity of the data. Scan the appropriate barcode below to transmit the barcode data with or without the UPC-E check digit. It is always verified to guarantee the integrity of the data.



*** Transmit UPC-E Check Digit
(1)**



**Do Not Transmit UPC-E Check Digit
(0)**

Transmit UPC-E1 Check Digit

Parameter # 42 (SSI # 2Ah)

The check digit is the last character of the symbol used to verify the integrity of the data. Scan the appropriate barcode below to transmit the barcode data with or without the UPC-E1 check digit. It is always verified to guarantee the integrity of the data.

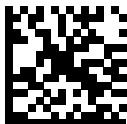

*** Transmit UPC-E1 Check Digit
(1)**



**Do Not Transmit UPC-E1 Check Digit
(0)**

UPC-A Preamble

Parameter # 34 (SSI # 22h)

Preamble characters are part of the UPC symbol, and include Country Code and System Character. There are three options for transmitting a UPC-A preamble to the host device: transmit System Character only, transmit System Character and Country Code ("0" for USA), and transmit no preamble. Select the appropriate option to match the host system.



No Preamble (<DATA>)
(0)



* System Character (<SYSTEM CHARACTER>
<DATA>)
(1)



System Character & Country Code
(< COUNTRY CODE> <SYSTEM CHARACTER>
<DATA>)
(2)

UPC-E Preamble

Parameter # 35 (SSI # 23h)

Preamble characters are part of the UPC symbol, and include Country Code and System Character. There are three options for transmitting a UPC-E preamble to the host device: transmit System Character only, transmit System Character and Country Code ("0" for USA), and transmit no preamble. Select the appropriate option to match the host system.



No Preamble (<DATA>)
(0)



* System Character (<SYSTEM CHARACTER>
<DATA>)
(1)



System Character & Country Code
(< COUNTRY CODE> <SYSTEM CHARACTER>
<DATA>)
(2)

UPC-E1 Preamble

Parameter # 36 (SSI # 24h)

Preamble characters are part of the UPC symbol, and include Country Code and System Character. There are three options for transmitting a UPC-E1 preamble to the host device: transmit System Character only, transmit System Character and Country Code ("0" for USA), and transmit no preamble. Select the appropriate option to match the host system.



No Preamble (<DATA>)
(0)



* System Character (<SYSTEM CHARACTER> <DATA>)
(1)



System Character & Country Code
(< COUNTRY CODE> <SYSTEM CHARACTER> <DATA>)
(2)

Convert UPC-E to UPC-A

Parameter # 37 (SSI # 25h)

Enable this to convert UPC-E (zero suppressed) decoded data to UPC-A format before transmission. After conversion, the data follows UPC-A format and is affected by UPC-A programming selections (e.g., Preamble, Check Digit).

Disable this to transmit UPC-E decoded data as UPC-E data, without conversion.



Convert UPC-E to UPC-A (Enable)
(1)



* Do Not Convert UPC-E to UPC-A (Disable)
(0)

Convert UPC-E1 to UPC-A

Parameter # 38 (SSI # 26h)

Enable this to convert UPC-E1 decoded data to UPC-A format before transmission. After conversion, the data follows UPC-A format and is affected by UPC-A programming selections (e.g., Preamble, Check Digit).

Disable this to transmit UPC-E1 decoded data as UPC-E1 data, without conversion.



Convert UPC-E1 to UPC-A (Enable)
(1)



* Do Not Convert UPC-E1 to UPC-A (Disable)
(0)

EAN-8/JAN-8 Extend

Parameter # 39 (SSI # 27h)

Enable this parameter to add five leading zeros to decoded EAN-8 symbols to make them compatible in format to EAN-13 symbols. Disable this to transmit EAN-8 symbols as is.



Enable EAN/JAN Zero Extend
(1)



* Disable EAN/JAN Zero Extend
(0)

Bookland ISBN Format

Parameter # 576 (SSI # F1h 40h)

If you enabled Bookland EAN using [Enable/Disable Bookland EAN on page 13-11](#), select one of the following formats for Bookland data:

- **Bookland ISBN-10** - The digital scanner reports Bookland data starting with 978 in traditional 10-digit format with the special Bookland check digit for backward-compatibility. Data starting with 979 is not considered Bookland in this mode.
- **Bookland ISBN-13** - The digital scanner reports Bookland data (starting with either 978 or 979) as EAN-13 in 13-digit format to meet the 2007 ISBN-13 protocol.

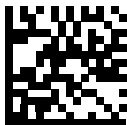

* Bookland ISBN-10
(0)



Bookland ISBN-13
(1)



NOTE For Bookland EAN to function properly, first enable Bookland EAN using [Enable/Disable Bookland EAN on page 13-11](#), then select either Decode UPC/EAN Supplementals, Autodiscriminate UPC/EAN Supplementals, or Enable 978/979 Supplemental Mode in [Decode UPC/EAN/JAN Supplementals on page 13-12](#).

UCC Coupon Extended Code

Parameter # 85 (SSI # 55h)

Enable this parameter to decode UPC-A barcodes starting with digit '5', EAN-13 barcodes starting with digit '99', and UPC-A/GS1-128 Coupon Codes. UPCA, EAN-13, and GS1-128 must be enabled to scan all types of Coupon Codes.



Enable UCC Coupon Extended Code
(1)



*** Disable UCC Coupon Extended Code**
(0)



NOTE See [UPC/EAN/JAN Supplemental Redundancy on page 13-15](#) to control autodiscrimination of the GS1-128 (right half) of a coupon code.

Coupon Report

Parameter # 730 (SSI # F1h DAh)

Select an option to determine which type of coupon format to support.

- Select **Old Coupon Format** to support UPC-A/GS1-128 and EAN-13/GS1-128.
- Select **New Coupon Format** as an interim format to support UPC-A/GS1-DataBar and EAN-13/GS1-DataBar.
- If you select **Autodiscriminate Format**, the digital scanner supports both **Old Coupon Format** and **New Coupon Format**.

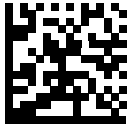

Old Coupon Format
(0)



* New Coupon Format
(1)



Autodiscriminate Coupon Format
(2)

ISSN EAN

Parameter # 617 (SSI # F1h 69h)

To enable or disable ISSN EAN, scan the appropriate barcode below.



Enable ISSN EAN
(1)



* Disable ISSN EAN
(0)

Code 128

Enable/Disable Code 128

Parameter # 8 (SSI # 08h)

To enable or disable Code 128, scan the appropriate barcode below.



* Enable Code 128
(1)



Disable Code 128
(0)

Set Lengths for Code 128

Parameter # L1 = 209 (SSI # D1h), L2 = 210 (SSI # D2h)

The length of a code refers to the number of characters (i.e., human readable characters), including check digit(s) the code contains. Set lengths for Code 128 to any length, one or two discrete lengths, or lengths within a specific range. The default is 1 to 55.

✓ **NOTE** When setting lengths for different barcode types, enter a leading zero for single digit numbers.

- **One Discrete Length** - Select this option to decode only Code 128 symbols containing a selected length. Select the length using the numeric barcodes in [Appendix H, Numeric Bar Codes](#). For example, to decode only Code 128 symbols with 14 characters, scan **Code 128 - One Discrete Length**, then scan **1** followed by **4**. To correct an error or change the selection, scan [Cancel on page H-2](#).
- **Two Discrete Lengths** - Select this option to decode only Code 128 symbols containing either of two selected lengths. Select lengths using the numeric barcodes in [Appendix H, Numeric Bar Codes](#). For example, to decode only Code 128 symbols containing either 2 or 14 characters, select **Code 128 - Two Discrete Lengths**, then scan **0**, **2**, **1**, and then **4**. To correct an error or change the selection, scan [Cancel on page H-2](#).
- **Length Within Range** - Select this option to decode a Code 128 symbol with a specific length range. Select lengths using numeric barcodes in [Appendix H, Numeric Bar Codes](#). For example, to decode Code 128 symbols containing between 4 and 12 characters, first scan **Code 128 - Length Within Range**. Then scan **0**, **4**, **1**, and **2** (enter a leading zero for single digit numbers). To correct an error or change the selection, scan [Cancel on page H-2](#).
- **Any Length** - Select this option to decode Code 128 symbols containing any number of characters within the digital scanner's capability.

Set Lengths for Code 128 (continued)

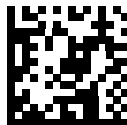

Code 128 - One Discrete Length



Code 128 - Two Discrete Lengths



Code 128 - Length Within Range



Code 128 - Any Length

Enable/Disable GS1-128 (formerly UCC/EAN-128)**Parameter # 14 (SSI # 0Eh)**

To enable or disable GS1-128, scan the appropriate barcode below.

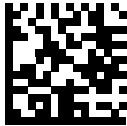

*** Enable GS1-128
(1)**



**Disable GS1-128
(0)**

Enable/Disable ISBT 128**Parameter # 84 (SSI # 54h)**

ISBT 128 is a variant of Code 128 used in the blood bank industry. Scan a barcode below to enable or disable ISBT 128. If necessary, the host must perform concatenation of the ISBT data.



**Enable ISBT 128
(1)**



*** Disable ISBT 128
(0)**

ISBT Concatenation

Parameter # 577 (SSI # F1h 41h)

Select an option for concatenating pairs of ISBT code types:

- If you select **Disable ISBT Concatenation**, the digital scanner does not concatenate pairs of ISBT codes it encounters.
- If you select **Enable ISBT Concatenation**, there must be two ISBT codes in order for the digital scanner to decode and perform concatenation. The digital scanner does not decode single ISBT symbols.
- If you select **Autodiscriminate ISBT Concatenation**, the digital scanner decodes and concatenates pairs of ISBT codes immediately. If only a single ISBT symbol is present, the digital scanner must decode the symbol the number of times set via [ISBT Concatenation Redundancy on page 13-31](#) before transmitting its data to confirm that there is no additional ISBT symbol.



Disable ISBT Concatenation
(0)



Enable ISBT Concatenation
(1)

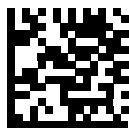

*** Autodiscriminate ISBT Concatenation**
(2)

Check ISBT Table

Parameter # 578 (SSI # F1h 42h)

The ISBT specification includes a table that lists several types of ISBT barcodes that are commonly used in pairs. If you set **ISBT Concatenation** to **Enable**, enable **Check ISBT Table** to concatenate only those pairs found in this table. Other types of ISBT codes are not concatenated.



* Enable Check ISBT Table
(1)



Disable Check ISBT Table
(0)

ISBT Concatenation Redundancy

Parameter # 223 (SSI # DFh)

If you set **ISBT Concatenation** to **Autodiscriminate**, use this parameter to set the number of times the digital scanner must decode an ISBT symbol before determining that there is no additional symbol.

Scan the barcode below, then scan two numeric barcodes in [Appendix H, Numeric Bar Codes](#) to set a value between 2 and 20. Enter a leading zero for single digit numbers. To correct an error or change a selection, scan [Cancel on page H-2](#). The default is 10.



ISBT Concatenation Redundancy

Code 128 Security Level

Parameter # 751 (SSI # F1h EFh)

Code 128 barcodes are vulnerable to misdecodes, particularly when Code 128 Lengths is set to **Any Length**. The digital scanner offers four levels of decode security for Code 128 barcodes. There is an inverse relationship between security and digital scanner aggressiveness. Increasing the level of security can reduce scanning aggressiveness, so select only the level of security necessary.

- **Code 128 Security Level 0:** This setting allows the digital scanner to operate in its most aggressive state, while providing sufficient security in decoding most in-spec barcodes.
- **Code 128 Security Level 1:** A barcode must be successfully read twice, and satisfy certain safety requirements before being decoded. This default setting eliminates most misdecodes.
- **Code 128 Security Level 2:** Select this option with greater barcode security requirements if **Security Level 1** fails to eliminate misdecodes.
- **Code 128 Security Level 3:** If you selected **Security Level 2**, and misdecodes still occur, select this security level to apply the highest safety requirements. A barcode must be successfully read three times before being decoded.

✓ **NOTE** Selecting this option is an extreme measure against mis-decoding severely out-of-spec barcodes. Selecting this level of security significantly impairs the decoding ability of the digital scanner. If this level of security is required, try to improve the quality of the barcodes.



Code 128 Security Level 0
(0)



* Code 128 Security Level 1
(1)



Code 128 Security Level 2
(2)



Code 128 Security Level 3
(3)

Code 128 Reduced Quiet Zone

Parameter # 1208 (SSI # F8h 04h B8h)

Scan one of the following barcodes to enable or disable decoding Code 128 barcodes with reduced quiet zones. If you select **Enable**, select a [1D Quiet Zone Level on page 13-107](#).



Enable Code 128 Reduced Quiet Zone
(1)



* Disable Code 128 Reduced Quiet Zone
(0)

Ignore Code 128 <FNC4>

Parameter # 1254 (SSI # F8h 04h E6h)

This feature applies to Code 128 barcodes with an embedded <FNC4> character. Enable this to strip the <FNC4> character from the decode data. The remaining characters are sent to the host unchanged. When disabled, the <FNC4> character is processed normally as per Code 128 standard.



Enable Ignore Code 128 <FNC4>
(1)



* Disable Ignore Code 128 <FNC4>
(0)

Code 39

Enable/Disable Code 39

Parameter # 0 (SSI # 00h)

To enable or disable Code 39, scan the appropriate barcode below.

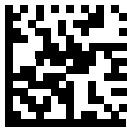

* Enable Code 39
(1)



Disable Code 39
(0)

Enable/Disable Trioptic Code 39

Parameter # 13 (SSI # 0Dh)

Trioptic Code 39 is a variant of Code 39 used in the marking of computer tape cartridges. Trioptic Code 39 symbols always contain six characters. To enable or disable Trioptic Code 39, scan the appropriate barcode below.

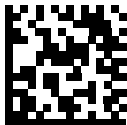

Enable Trioptic Code 39
(1)



* Disable Trioptic Code 39
(0)



NOTE You cannot enable Trioptic Code 39 and Code 39 Full ASCII simultaneously.

Convert Code 39 to Code 32

Parameter # 86 (SSI # 56h)

Code 32 is a variant of Code 39 used by the Italian pharmaceutical industry. Scan the appropriate barcode below to enable or disable converting Code 39 to Code 32.

✓ **NOTE** Code 39 must be enabled for this parameter to function.

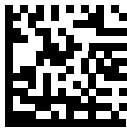

Enable Convert Code 39 to Code 32
(1)



* Disable Convert Code 39 to Code 32
(0)

Code 32 Prefix

Parameter # 231 (SSI # E7h)

Scan the appropriate barcode below to enable or disable adding the prefix character "A" to all Code 32 barcodes.

✓ **NOTE** Convert Code 39 to Code 32 must be enabled for this parameter to function.



Enable Code 32 Prefix
(1)



* Disable Code 32 Prefix
(0)

Set Lengths for Code 39

Parameter # L1 = 18 (SSI # 12h), L2 = 19 (SSI # 13h)

The length of a code refers to the number of characters (i.e., human readable characters), including check digit(s) the code contains. Set lengths for Code 39 to any length, one or two discrete lengths, or lengths within a specific range. If Code 39 Full ASCII is enabled, **Length Within a Range** or **Any Length** are the preferred options. The default is 1 to 55.



NOTE When setting lengths for different barcode types, enter a leading zero for single digit numbers.

- **One Discrete Length** - Select this option to decode only Code 39 symbols containing a selected length. Select the length using the numeric barcodes in [Appendix H, Numeric Bar Codes](#). For example, to decode only Code 39 symbols with 14 characters, scan **Code 39 - One Discrete Length**, then scan **1** followed by **4**. To correct an error or change the selection, scan [Cancel on page H-2](#).
- **Two Discrete Lengths** - Select this option to decode only Code 39 symbols containing either of two selected lengths. Select lengths using the numeric barcodes in [Appendix H, Numeric Bar Codes](#). For example, to decode only Code 39 symbols containing either 2 or 14 characters, select **Code 39 - Two Discrete Lengths**, then scan **0, 2, 1**, and then **4**. To correct an error or change the selection, scan [Cancel on page H-2](#).
- **Length Within Range** - Select this option to decode a Code 39 symbol with a specific length range. Select lengths using numeric barcodes in [Appendix H, Numeric Bar Codes](#). For example, to decode Code 39 symbols containing between 4 and 12 characters, first scan **Code 39 - Length Within Range**. Then scan **0, 4, 1**, and **2** (enter a leading zero for single digit numbers). To correct an error or change the selection, scan [Cancel on page H-2](#).
- **Any Length** - Select this option to decode Code 39 symbols containing any number of characters within the digital scanner's capability.



Code 39 - One Discrete Length



Code 39 - Two Discrete Lengths



Code 39 - Length Within Range



Code 39 - Any Length

Code 39 Check Digit Verification

Parameter # 48 (SSI # 30h)

Enable this feature to check the integrity of all Code 39 symbols to verify that the data complies with specified check digit algorithm. Only Code 39 symbols which include a modulo 43 check digit are decoded. Enable this feature if the Code 39 symbols contain a Modulo 43 check digit.



Enable Code 39 Check Digit
(1)



* Disable Code 39 Check Digit
(0)

Transmit Code 39 Check Digit

Parameter # 43 (SSI # 2Bh)

Scan a barcode below to transmit Code 39 data with or without the check digit.

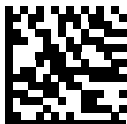

Transmit Code 39 Check Digit (Enable)
(1)



* Do Not Transmit Code 39 Check Digit (Disable)
(0)



NOTE Code 39 Check Digit Verification must be enabled for this parameter to function.

Code 39 Full ASCII Conversion

Parameter # 17 (SSI # 11h)

Code 39 Full ASCII is a variant of Code 39 which pairs characters to encode the full ASCII character set. To enable or disable Code 39 Full ASCII, scan the appropriate barcode below.

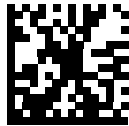

Enable Code 39 Full ASCII
(1)



*** Disable Code 39 Full ASCII**
(0)



NOTE You cannot enable Trioptic Code 39 and Code 39 Full ASCII simultaneously.

Code 39 Full ASCII to Full ASCII Correlation is host-dependent, and is therefore described in the ASCII Character Set Table for the appropriate interface. See the [ASCII Character Sets on page I-1](#).

Code 39 Security Level

Parameter # 750 (SSI # F1h EEh)

The digital scanner offers four levels of decode security for Code 39 barcodes. There is an inverse relationship between security and digital scanner aggressiveness. Increasing the level of security can reduce scanning aggressiveness, so select only the level of security necessary.

- **Code 39 Security Level 0:** This setting allows the digital scanner to operate in its most aggressive state, while providing sufficient security in decoding most in-spec barcodes.
- **Code 39 Security Level 1:** This default setting eliminates most misdecodes.
- **Code 39 Security Level 2:** Select this option with greater barcode security requirements if **Security Level 1** fails to eliminate misdecodes.
- **Code 39 Security Level 3:** If you selected **Security Level 2**, and misdecodes still occur, select this security level to apply the highest safety requirements.

✓ **NOTE** Selecting this option is an extreme measure against mis-decoding severely out-of-spec barcodes. Selecting this level of security significantly impairs the decoding ability of the digital scanner. If this level of security is required, try to improve the quality of the barcodes.

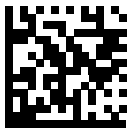

Code 39 Security Level 0
(0)



* Code 39 Security Level 1
(1)



Code 39 Security Level 2
(2)

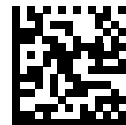

Code 39 Security Level 3
(3)

Code 39 Reduced Quiet Zone

Parameter # 1209 (SSI # F8h 04h B9h)

Scan one of the following barcodes to enable or disable decoding Code 39 barcodes with reduced quiet zones. If you select **Enable**, select a [1D Quiet Zone Level on page 13-107](#).

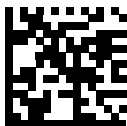

Enable Code 39 Reduced Quiet Zone
(1)



* Disable Code 39 Reduced Quiet Zone
(0)

Code 93

Enable/Disable Code 93

Parameter # 9 (SSI # 09h)

To enable or disable Code 93, scan the appropriate barcode below.



* Enable Code 93
(1)



Disable Code 93
(0)

Set Lengths for Code 93

Parameter # L1 = 26 (SSI # 1Ah), L2 = 27 (SSI # 1Bh)

The length of a code refers to the number of characters (i.e., human readable characters), including check digit(s) the code contains. Set lengths for Code 93 to any length, one or two discrete lengths, or lengths within a specific range. The default is 1 to 55.

- **One Discrete Length** - Select this option to decode only Code 93 symbols containing a selected length. Select the length using the numeric barcodes in [Appendix H, Numeric Bar Codes](#). For example, to decode only Code 93 symbols with 14 characters, scan **Code 93 - One Discrete Length**, then scan **1** followed by **4**. To correct an error or to change the selection, scan [Cancel on page H-2](#).
- **Two Discrete Lengths** - Select this option to decode only Code 93 symbols containing either of two selected lengths. Select lengths using the numeric barcodes in [Appendix H, Numeric Bar Codes](#). For example, to decode only Code 93 symbols containing either 2 or 14 characters, select **Code 93 - Two Discrete Lengths**, then scan **0**, **2**, **1**, and then **4**. To correct an error or to change the selection, scan [Cancel on page H-2](#).
- **Length Within Range** - Select this option to decode a Code 93 symbol with a specific length range. Select lengths using the numeric barcodes in [Appendix H, Numeric Bar Codes](#). For example, to decode Code 93 symbols containing between 4 and 12 characters, first scan **Code 93 - Length Within Range**. Then scan **0**, **4**, **1**, and **2** (enter a leading zero for single digit numbers). To correct an error or change the selection, scan [Cancel on page H-2](#).
- **Any Length** - Scan this option to decode Code 93 symbols containing any number of characters within the digital scanner's capability.

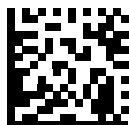

Code 93 - One Discrete Length



Code 93 - Two Discrete Lengths

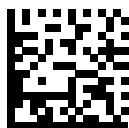

Code 93 - Length Within Range



Code 93 - Any Length

Code 11

Code 11

Parameter # 10 (SSI # 0Ah)

To enable or disable Code 11, scan the appropriate barcode below.



Enable Code 11
(1)



*** Disable Code 11**
(0)

Set Lengths for Code 11

Parameter # L1 = 28 (SSI # 1Ch), L2 = 29 (SSI # 1Dh)

The length of a code refers to the number of characters (i.e., human readable characters), including check digit(s) the code contains. Set lengths for Code 11 to any length, one or two discrete lengths, or lengths within a specific range. The default is 4 to 55.

- **One Discrete Length** - Select this option to decode only Code 11 symbols containing a selected length. Select the length using the numeric barcodes in [Appendix H, Numeric Bar Codes](#). For example, to decode only Code 11 symbols with 14 characters, scan **Code 11 - One Discrete Length**, then scan **1** followed by **4**. To correct an error or to change the selection, scan [Cancel on page H-2](#).
- **Two Discrete Lengths** - Select this option to decode only Code 11 symbols containing either of two selected lengths. Select lengths using the numeric barcodes in [Appendix H, Numeric Bar Codes](#). For example, to decode only Code 11 symbols containing either 2 or 14 characters, select **Code 11 - Two Discrete Lengths**, then scan **0**, **2**, **1**, and then **4**. To correct an error or to change the selection, scan [Cancel on page H-2](#).
- **Length Within Range** - Select this option to decode a Code 11 symbol with a specific length range. Select lengths using numeric barcodes in [Appendix H, Numeric Bar Codes](#). For example, to decode Code 11 symbols containing between 4 and 12 characters, first scan **Code 11 - Length Within Range**. Then scan **0**, **4**, **1**, and **2** (enter a leading zero for single digit numbers). To correct an error or change the selection, scan [Cancel on page H-2](#).
- **Any Length** - Scan this option to decode Code 11 symbols containing any number of characters within the digital scanner's capability.



Code 11 - One Discrete Length



Code 11 - Two Discrete Lengths

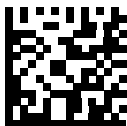

Code 11 - Length Within Range



Code 11 - Any Length

Code 11 Check Digit Verification

Parameter # 52 (SSI # 34h)

This feature allows the digital scanner to check the integrity of all Code 11 symbols to verify that the data complies with the specified check digit algorithm. This selects the check digit mechanism for the decoded Code 11 barcode. The options are to check for one check digit, check for two check digits, or disable the feature.

To enable this feature, scan the barcode below corresponding to the number of check digits encoded in the Code 11 symbols.

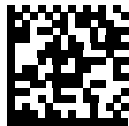

* Disable
(0)



One Check Digit
(1)



Two Check Digits
(2)

Transmit Code 11 Check Digits

Parameter # 47 (SSI # 2Fh)

This feature selects whether or not to transmit the Code 11 check digit(s).



Transmit Code 11 Check Digit(s) (Enable)
(1)



* Do Not Transmit Code 11 Check Digit(s) (Disable)
(0)



NOTE Code 11 Check Digit Verification must be enabled for this parameter to function.

Interleaved 2 of 5 (ITF)

Enable/Disable Interleaved 2 of 5

Parameter # 6 (SSI # 06h)

To enable or disable Interleaved 2 of 5, scan the appropriate barcode below, and select an Interleaved 2 of 5 length from the following pages.

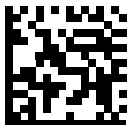

Enable Interleaved 2 of 5
(1)



* Disable Interleaved 2 of 5
(0)

Set Lengths for Interleaved 2 of 5

Parameter # L1 = 22 (SSI # 16h), L2 = 23 (SSI # 17h)

The length of a code refers to the number of characters (i.e., human readable characters), including check digit(s) the code contains. Set lengths for I 2 of 5 to any length, one or two discrete lengths, or lengths within a specific range. The range for Interleaved 2 of 5 lengths is 0 - 55. The default is 6 to 55.

- **One Discrete Length** - Select this option to decode only I 2 of 5 symbols containing a selected length. Select the length using the numeric barcodes in [Appendix H, Numeric Bar Codes](#). For example, to decode only I 2 of 5 symbols with 14 characters, scan **I 2 of 5 - One Discrete Length**, then scan **1** followed by **4**. To correct an error or to change the selection, scan [Cancel on page H-2](#).
- **Two Discrete Lengths** - Select this option to decode only I 2 of 5 symbols containing either of two selected lengths. Select lengths using the numeric barcodes in [Appendix H, Numeric Bar Codes](#). For example, to decode only I 2 of 5 symbols containing either 2 or 14 characters, select **I 2 of 5 - Two Discrete Lengths**, then scan **0**, **2**, **1**, and then **4**. To correct an error or to change the selection, scan [Cancel on page H-2](#).
- **Length Within Range** - Select this option to decode an I 2 of 5 symbol with a specific length range. Select lengths using numeric barcodes in [Appendix H, Numeric Bar Codes](#). For example, to decode I 2 of 5 symbols containing between 4 and 12 characters, first scan **I 2 of 5 - Length Within Range**. Then scan **0**, **4**, **1**, and **2** (enter a leading zero for single digit numbers). To correct an error or change the selection, scan [Cancel on page H-2](#).
- **Any Length** - Scan this option to decode I 2 of 5 symbols containing any number of characters within the digital scanner's capability.

✓ **NOTE** Due to the construction of the I 2 of 5 symbology, it is possible for a scan covering only a portion of the code to transmit as a complete scan, yielding less data than is encoded in the barcode. To prevent this, select specific lengths (I 2 of 5 - One Discrete Length, Two Discrete Lengths) for I 2 of 5 applications.

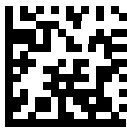

I 2 of 5 - One Discrete Length



I 2 of 5 - Two Discrete Lengths



I 2 of 5 - Length Within Range



I 2 of 5 - Any Length

I 2 of 5 Check Digit Verification

Parameter # 49 (SSI # 31h)

Enable this feature to check the integrity of all I 2 of 5 symbols to verify the data complies with either the specified Uniform Symbology Specification (USS), or the Optical Product Code Council (OPCC) check digit algorithm.



* Disable
(0)



USS Check Digit
(1)



OPCC Check Digit
(2)

Transmit I 2 of 5 Check Digit

Parameter # 44 (SSI # 2Ch)

Scan the appropriate barcode below to transmit I 2 of 5 data with or without the check digit.



Transmit I 2 of 5 Check Digit (Enable)
(1)



*** Do Not Transmit I 2 of 5 Check Digit (Disable)**
(0)

Convert I 2 of 5 to EAN-13

Parameter # 82 (SSI # 52h)

Enable this parameter to convert 14-character I 2 of 5 codes to EAN-13, and transmit to the host as EAN-13. To accomplish this, the I 2 of 5 code must be enabled, and the code must have a leading zero and a valid EAN-13 check digit.



Convert I 2 of 5 to EAN-13 (Enable)
(1)



*** Do Not Convert I 2 of 5 to EAN-13 (Disable)**
(0)

I 2 of 5 Security Level

Parameter # 1121 (SSI # F8h 04h 61h)

Interleaved 2 of 5 barcodes are vulnerable to misdecodes, particularly when I 2 of 5 Lengths is set to **Any Length**. The digital scanner offers four levels of decode security for Interleaved 2 of 5 barcodes. There is an inverse relationship between security and digital scanner aggressiveness. Increasing the level of security can reduce scanning aggressiveness, so select only the level of security necessary.

- **I 2 of 5 Security Level 0:** This setting allows the digital scanner to operate in its most aggressive state, while providing sufficient security in decoding most in-spec barcodes.
- **I 2 of 5 Security Level 1:** A barcode must be successfully read twice, and satisfy certain safety requirements before being decoded. This default setting eliminates most misdecodes.
- **I 2 of 5 Security Level 2:** Select this option with greater barcode security requirements if **Security Level 1** fails to eliminate misdecodes.
- **I 2 of 5 Security Level 3:** If you selected **Security Level 2**, and misdecodes still occur, select this security level. The highest safety requirements are applied. A barcode must be successfully read three times before being decoded.

✓ **NOTE** Selecting this option is an extreme measure against mis-decoding severely out-of-spec barcodes. Selecting this level of security significantly impairs the decoding ability of the digital scanner. If this level of security is required, try to improve the quality of the barcodes.



I 2 of 5 Security Level 0
(0)



* I 2 of 5 Security Level 1
(1)



I 2 of 5 Security Level 2
(2)



I 2 of 5 Security Level 3
(3)

I 2 of 5 Reduced Quiet Zone

Parameter # 1210 (SSI # F8h 04h BAh)

Scan one of the following barcodes to enable or disable decoding I 2 of 5 barcodes with reduced quiet zones. If you select **Enable**, select a [1D Quiet Zone Level on page 13-107](#).



Enable I 2 of 5 Reduced Quiet Zone
(1)



* Disable I 2 of 5 Reduced Quiet Zone
(0)

Discrete 2 of 5 (DTF)

Enable/Disable Discrete 2 of 5

Parameter # 5 (SSI # 05h)

To enable or disable Discrete 2 of 5, scan the appropriate barcode below.

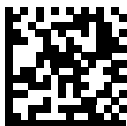

Enable Discrete 2 of 5
(1)



* Disable Discrete 2 of 5
(0)

Set Lengths for Discrete 2 of 5

Parameter # L1 = 20 (SSI # 14h), L2 = 21 (SSI # 15h)

The length of a code refers to the number of characters (i.e., human readable characters), including check digit(s) the code contains. Set lengths for D 2 of 5 to any length, one or two discrete lengths, or lengths within a specific range. The range for Discrete 2 of 5 lengths is 1 - 55.

- **One Discrete Length** - Select this option to decode only D 2 of 5 symbols containing a selected length. Select the length using the numeric barcodes in [Appendix H, Numeric Bar Codes](#). For example, to decode only D 2 of 5 symbols with 14 characters, scan **D 2 of 5 - One Discrete Length**, then scan **1** followed by **4**. To correct an error or to change the selection, scan [Cancel on page H-2](#).
- **Two Discrete Lengths** - Select this option to decode only D 2 of 5 symbols containing either of two selected lengths. Select lengths using the numeric barcodes in [Appendix H, Numeric Bar Codes](#). For example, to decode only D 2 of 5 symbols containing either 2 or 14 characters, select **D 2 of 5 - Two Discrete Lengths**, then scan **0**, **2**, **1**, and then **4**. To correct an error or to change the selection, scan [Cancel on page H-2](#).
- **Length Within Range** - Select this option to decode a D 2 of 5 symbol with a specific length range. Select lengths using numeric barcodes in [Appendix H, Numeric Bar Codes](#). For example, to decode D 2 of 5 symbols containing between 4 and 12 characters, first scan **D 2 of 5 - Length Within Range**. Then scan **0**, **4**, **1**, and **2** (enter a leading zero for single digit numbers). To correct an error or change the selection, scan [Cancel on page H-2](#).
- **Any Length** - Scan this option to decode D 2 of 5 symbols containing any number of characters within the digital scanner's capability.

✓ **NOTE** Due to the construction of the D 2 of 5 symbology, it is possible for a scan covering only a portion of the code to transmit as a complete scan, yielding less data than is encoded in the barcode. To prevent this, select specific lengths (**D 2 of 5 - One Discrete Length, Two Discrete Lengths**) for D 2 of 5 applications.



D 2 of 5 - One Discrete Length



D 2 of 5 - Two Discrete Lengths



D 2 of 5 - Length Within Range



D 2 of 5 - Any Length

Codabar (NW - 7)

Enable/Disable Codabar

Parameter # 7 (SSI # 07h)

To enable or disable Codabar, scan the appropriate barcode below.

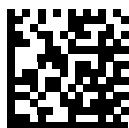

* Enable Codabar
(1)



Disable Codabar
(0)

Set Lengths for Codabar

Parameter # L1 = 24 (SSI # 18h), L2 = 25 (SSI # 19h)

The length of a code refers to the number of characters (i.e., human readable characters), including check digit(s) the code contains. Set lengths for Codabar to any length, one or two discrete lengths, or lengths within a specific range. The default is 4 to 55.

- **One Discrete Length** - Select this option to decode only Codabar symbols containing a selected length. Select the length using the numeric barcodes in [Appendix H, Numeric Bar Codes](#). For example, to decode only Codabar symbols with 14 characters, scan **Codabar - One Discrete Length**, then scan **1** followed by **4**. To correct an error or to change the selection, scan [Cancel on page H-2](#).
- **Two Discrete Lengths** - Select this option to decode only Codabar symbols containing either of two selected lengths. Select lengths using the numeric barcodes in [Appendix H, Numeric Bar Codes](#). For example, to decode only Codabar symbols containing either 2 or 14 characters, select **Codabar - Two Discrete Lengths**, then scan **0**, **2**, **1**, and then **4**. To correct an error or to change the selection, scan [Cancel on page H-2](#).
- **Length Within Range** - Select this option to decode a Codabar symbol with a specific length range. Select lengths using numeric barcodes in [Appendix H, Numeric Bar Codes](#). For example, to decode Codabar symbols containing between 4 and 12 characters, first scan **Codabar - Length Within Range**. Then scan **0**, **4**, **1**, and **2** (enter a leading zero for single digit numbers). To correct an error or change the selection, scan [Cancel on page H-2](#).
- **Any Length** - Scan this option to decode Codabar symbols containing any number of characters within the digital scanner's capability.

Set Lengths for Codabar (continued)



Codabar - One Discrete Length



Codabar - Two Discrete Lengths



Codabar - Length Within Range



Codabar - Any Length

CLSI Editing

Parameter # 54 (SSI # 36h)

Enable this parameter to strip the start and stop characters and insert a space after the first, fifth, and tenth characters of a 14-character Codabar symbol. Enable this feature if the host system requires this data format.

✓ **NOTE** Symbol length does not include start and stop characters.

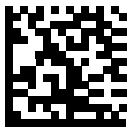

Enable CLSI Editing
(1)



* Disable CLSI Editing
(0)

NOTIS Editing

Parameter # 55 (SSI # 37h)

Enable this parameter to strip the start and stop characters from a decoded Codabar symbol. Enable this feature if the host system requires this data format.



Enable NOTIS Editing
(1)



* Disable NOTIS Editing
(0)

Codabar Security Level

Parameter # 1776 (SSI # F8h 06h F0h)

The digital scanner offers four levels of decode security for Codabar barcodes. There is an inverse relationship between security and scanner aggressiveness. Increasing the level of security can reduce scanning aggressiveness, so select only the level of security necessary.

- ✓ **NOTE** This parameter applies to all DS36X8 configurations with the exception of the DS36X8-DP and DS36X8-DPA.
- **Codabar Security Level 0:** This setting allows the scanner to operate in its most aggressive state, while providing sufficient security in decoding most in-spec barcodes.
- **Codabar Security Level 1:** This default setting eliminates most misdecodes.
- **Codabar Security Level 2:** Select this option with greater barcode security requirements if **Security Level 1** fails to eliminate misdecodes.
- **Codabar Security Level 3:** If you selected **Security Level 2**, and misdecodes still occur, select this security level to apply the highest safety requirements.
- ✓ **NOTE** Selecting this option is an extreme measure against mis-decoding severely out-of-spec barcodes, and significantly impairs the decoding ability of the scanner. If this level of security is required, try to improve the quality of the barcodes.

Codabar Security Level (continued)



**Codabar Security Level 0
(0)**



***Codabar Security Level 1
(1)**

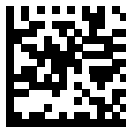

**Codabar Security Level 2
(2)**



**Codabar Security Level 3
(3)**

Codabar Upper or Lower Case Start/Stop Characters Detection

Parameter # 855 (SSI # F2h 57h)

Select whether to detect upper case or lower case Codabar start/stop characters.



Lower Case
(1)



* Upper Case
(0)

Codabar Mod 16 Check Digit Verification

Parameter # 1784 (SSI # F8h 06h F8h)

Enable this feature to check the Codabar Mod 16 Check Digit to verify that the data complies with the specified check digit algorithm.

✓ **NOTE** This parameter applies to all DS36X8 configurations with the exception of the DS36X8-DP and DS36X8-DPA.

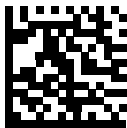

Enable Codabar Mod 16 Checkdigit
(1)



* Disable Codabar Mod 16 Checkdigit
(0)

Transmit Codabar Check Digit

Parameter # 704 (SSI # F1h C0h)

Scan one of the following barcodes to select whether or not to transmit the Codabar check digit(s).



NOTE *Codabar Mod 16 Check Digit Verification* must be enabled for this parameter to function.

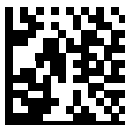

Enable Codabar Check Digit Transmission
(1)



*** Disable Codabar Check Digit Transmission**
(0)

MSI

Enable/Disable MSI

Parameter # 11 (SSI # 0Bh)

To enable or disable MSI, scan the appropriate barcode below.



Enable MSI
(1)



*** Disable MSI**
(0)

Set Lengths for MSI

Parameter # L1 = 30 (SSI # 1Eh), L2 = 31 (SSI # 1Fh)

The length of a code refers to the number of characters (i.e., human readable characters), including check digit(s) the code contains. Set lengths for MSI to any length, one or two discrete lengths, or lengths within a specific range. The default is 4 to 55.

- **One Discrete Length** - Select this option to decode only MSI symbols containing a selected length. Select the length using the numeric barcodes in [Appendix H, Numeric Bar Codes](#). For example, to decode only MSI symbols with 14 characters, scan **MSI - One Discrete Length**, then scan **1** followed by **4**. To correct an error or to change the selection, scan [Cancel on page H-2](#).
- **Two Discrete Lengths** - Select this option to decode only MSI symbols containing either of two selected lengths. Select lengths using the numeric barcodes in [Appendix H, Numeric Bar Codes](#). For example, to decode only MSI symbols containing either 2 or 14 characters, select **MSI - Two Discrete Lengths**, then scan **0**, **2**, **1**, and then **4**. To correct an error or to change the selection, scan [Cancel on page H-2](#).
- **Length Within Range** - Select this option to decode a MSI symbol with a specific length range. Select lengths using numeric barcodes in [Appendix H, Numeric Bar Codes](#). For example, to decode MSI symbols containing between 4 and 12 characters, first scan **MSI - Length Within Range**. Then scan **0**, **4**, **1**, and **2** (enter a leading zero for single digit numbers). To correct an error or change the selection, scan [Cancel on page H-2](#).
- **Any Length** - Scan this option to decode MSI symbols containing any number of characters within the digital scanner's capability.

✓ **NOTE** Due to the construction of the MSI symbology, it is possible for a scan covering only a portion of the code to transmit as a complete scan, yielding less data than is encoded in the barcode. To prevent this, select specific lengths (**MSI - One Discrete Length, Two Discrete Lengths**) for MSI applications.

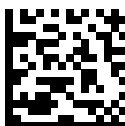

MSI - One Discrete Length



MSI - Two Discrete Lengths



MSI - Length Within Range



MSI - Any Length

MSI Check Digits

Parameter # 50 (SSI # 32h)

For the SR, ER, and HD configurations, MSI symbols are either no check digit or check digit(s). **One MSI Check Digit (1)** is the default. There are three options as follows:

0 - Doesn't check MSI check digit. Decodes MSI with no check digit.

1 - MSI barcodes with 1 check digit. This is the default.

2 - MSI barcodes with 2 check digits.

For the DP configuration, MSI symbols are check digit(s) only. **One MSI Check Digit (0)** is the default. There are three options as follows:

0 - MSI barcodes with 1 check digit. This is the default.

1 - MSI barcodes with 2 check digits.

See [MSI Check Digit Algorithm on page 13-64](#) for the selection of second digit algorithms.



None (0) - For SR, ER, HD Configurations
* One MSI Check Digit (0) - For DP Configuration



* One MSI Check Digit (1) - For SR, ER, HD Configurations
Two MSI Check Digit (1) - For DP Configuration



Two MSI Check Digits
(2)

Transmit MSI Check Digit(s)

Parameter # 46 (SSI # 2Eh)

Scan a barcode below to transmit MSI data with or without the check digit.



Transmit MSI Check Digit(s) (Enable)
(1)

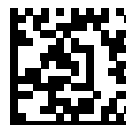

*** Do Not Transmit MSI Check Digit(s) (Disable)**
(0)

MSI Check Digit Algorithm

Parameter # 51 (SSI # 33h)

Two algorithms are possible for the verification of the second MSI check digit. Select the barcode below corresponding to the algorithm used to encode the check digit.



**MOD 11/MOD 10
(0)**



*** MOD 10/MOD 10
(1)**

MSI Reduced Quiet Zone

Parameter # 1392 (SSI # F8h 05h 70h)

Scan one of the following barcodes to enable or disable decoding MSI barcodes with reduced quiet zones. If you select **Enable**, select a [1D Quiet Zone Level on page 13-107](#).



***Disable MSI Reduced Quiet Zone
(0)**



**Enable MSI Reduced Quiet Zone
(1)**

Chinese 2 of 5

Enable/Disable Chinese 2 of 5

Parameter # 408 (SSI # F0h 98h)

To enable or disable Chinese 2 of 5, scan the appropriate barcode below.

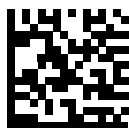

Enable Chinese 2 of 5
(1)



*** Disable Chinese 2 of 5**
(0)

Matrix 2 of 5

Enable/Disable Matrix 2 of 5

Parameter # 618 (SSI # F1h 6Ah)

To enable or disable Matrix 2 of 5, scan the appropriate barcode below.



Enable Matrix 2 of 5
(1)



* Disable Matrix 2 of 5
(0)

Set Lengths for Matrix 2 of 5

Parameter # L1 = 619 (SSI # F1h 6Bh), L2 = 620 (SSI # F1h 6Ch)

The length of a code refers to the number of characters (i.e., human readable characters), including check digit(s) the code contains. Set lengths for Matrix 2 of 5 to any length, one or two discrete lengths, or lengths within a specific range. The default is **4 to 55**.

- **One Discrete Length** - Select this option to decode only Matrix 2 of 5 symbols containing a selected length. Select the length using the numeric barcodes in [Appendix H, Numeric Bar Codes](#). For example, to decode only Matrix 2 of 5 symbols with 14 characters, scan **Matrix 2 of 5 - One Discrete Length**, then scan **1** followed by **4**. To correct an error or to change the selection, scan [Cancel on page H-2](#).
- **Two Discrete Lengths** - Select this option to decode only Matrix 2 of 5 symbols containing either of two selected lengths. Select lengths using the numeric barcodes in [Appendix H, Numeric Bar Codes](#). For example, to decode only Matrix 2 of 5 symbols containing either 2 or 14 characters, select **Matrix 2 of 5 - Two Discrete Lengths**, then scan **0, 2, 1**, and then **4**. To correct an error or to change the selection, scan [Cancel on page H-2](#).
- **Length Within Range** - Select this option to decode a Matrix 2 of 5 symbol with a specific length range. Select lengths using the numeric barcodes in [Appendix H, Numeric Bar Codes](#). For example, to decode Matrix 2 of 5 symbols containing between 4 and 12 characters, first scan **Matrix 2 of 5 - Length Within Range**. Then scan **0, 4, 1**, and **2** (enter a leading zero for single digit numbers). To correct an error or change the selection, scan [Cancel on page H-2](#).
- **Any Length** - Scan this option to decode Matrix 2 of 5 symbols containing any number of characters within the digital scanner's capability.



Matrix 2 of 5 - One Discrete Length



Matrix 2 of 5 - Two Discrete Lengths



Matrix 2 of 5 - Length Within Range



Matrix 2 of 5 - Any Length

Matrix 2 of 5 Check Digit

Parameter # 622 (SSI # F1h 6Eh)

The check digit is the last character of the symbol used to verify the integrity of the data. Scan the appropriate barcode below to transmit the barcode data with or without the Matrix 2 of 5 check digit.



Enable Matrix 2 of 5 Check Digit
(1)



*** Disable Matrix 2 of 5 Check Digit**
(0)

Transmit Matrix 2 of 5 Check Digit

Parameter # 623 (SSI # F1h 6Fh)

Scan a barcode below to transmit Matrix 2 of 5 data with or without the check digit.



Transmit Matrix 2 of 5 Check Digit
(1)



*** Do Not Transmit Matrix 2 of 5 Check Digit**
(0)

Korean 3 of 5

Enable/Disable Korean 3 of 5

Parameter # 581 (SSI # F1h 45h)

To enable or disable Korean 3 of 5, scan the appropriate barcode below.

✓ **NOTE** The length for Korean 3 of 5 is fixed at 6.



Enable Korean 3 of 5
(1)



* Disable Korean 3 of 5
(0)

Inverse 1D

Parameter # 586 (SSI # F1h 4Ah)

This parameter sets the 1D inverse decoder setting. Options are:

- **Regular Only** - the digital scanner decodes regular 1D barcodes only.
- **Inverse Only** - the digital scanner decodes inverse 1D barcodes only.
- **Inverse Autodetect** - the digital scanner decodes both regular and inverse 1D barcodes.

✓ **NOTE** The Inverse 1D setting may impact Composite or Inverse Composite decoding. See [Composite Inverse on page 13-77](#).

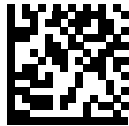

* Regular
(0)



Inverse Only
(1)



Inverse Autodetect
(2)

GS1 DataBar

The variants of GS1 DataBar are DataBar-14, DataBar Expanded, and DataBar Limited. The limited and expanded versions have stacked variants. Scan the appropriate barcodes to enable or disable each variant of GS1 DataBar.

GS1 DataBar-14

Parameter # 338 (SSI # F0h 52h)

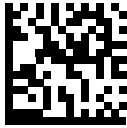

* Enable GS1 DataBar-14
(1)



Disable GS1 DataBar-14
(0)

GS1 DataBar Limited

Parameter # 339 (SSI # F0h 53h)

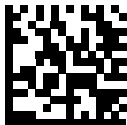

* Enable GS1 DataBar Limited
(1)



Disable GS1 DataBar Limited
(0)

GS1 DataBar Expanded

Parameter # 340 (SSI # F0h 54h)

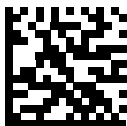

* Enable GS1 DataBar Expanded
(1)



Disable GS1 DataBar Expanded
(0)

Convert GS1 DataBar to UPC/EAN

Parameter # 397 (SSI # F0h, 8Dh)

This parameter only applies to GS1 DataBar-14 and GS1 DataBar Limited symbols not decoded as part of a Composite symbol. Enable this to strip the leading '010' from DataBar-14 and DataBar Limited symbols encoding a single zero as the first digit, and report the barcode as EAN-13.

For barcodes beginning with two or more zeros but not six zeros, this parameter strips the leading '0100' and reports the barcode as UPC-A. The UPC-A Preamble parameter that transmits the system character and country code applies to converted barcodes. Note that neither the system character nor the check digit can be stripped.



Enable Convert GS1 DataBar to UPC/EAN
(1)



* Disable Convert GS1 DataBar to UPC/EAN
(0)

GS1 DataBar Security Level

Parameter # 1706 (SSI # F8h 06h AAh)

The digital scanner offers four levels of decode security for GS1 DataBar (GS1 DataBar Omnidirectional, GS1 DataBar Limited, GS1 DataBar Expanded) barcodes.

- **Security Level 0** - The digital scanner operates in its most aggressive state, while providing sufficient security decoding most in-spec barcodes.
- **Security Level 1** - This setting eliminates most misdecodes while maintaining reasonable aggressiveness.
- **Security Level 2** - Select this option with greater barcode security requirements if Security Level 1 fails to eliminate misdecodes.
- **Security Level 3** - If you selected Security Level 2 and misdecodes still occur, select this security level to apply the highest safety requirements.

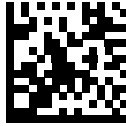

GS1 DataBar Security Level 0
(0)



*GS1 DataBar Security Level 1
(1)



GS1 DataBar Security Level 2
(2)



GS1 DataBar Security Level 3
(3)

GS1 DataBar Limited Margin Check

Parameter # 728 (SSI # F1h D8h)

The digital scanner offers four levels of decode security for GS1 DataBar Limited barcodes. There is an inverse relationship between the level of margin check and digital scanner aggressiveness. Increasing the level of margin check can reduce scanning aggressiveness, so select only that level of margin check necessary.

- **Margin Check Level 1** – No clear margin required. This complies with the original GS1 standard, yet can result in erroneous decoding of a DataBar Limited barcode when scanning some UPC symbols that start with digits 9 and 7.
- **Margin Check Level 2** – Automatic risk detection. This level of margin check can result in erroneous decoding of DataBar Limited barcodes when scanning some UPC symbols. If a misdecode is detected, the scanner operates in Level 3 or Level 1.
- **Margin Check Level 3** – Margin check level reflects the newly proposed GS1 standard that requires a five times trailing clear margin.
- **Margin Check Level 4** – Margin check level extends beyond the standard required by GS1. This level of margin check requires a five times leading and trailing clear margin.

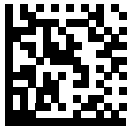

GS1 DataBar Limited Margin Check Level 1
(1)



GS1 DataBar Limited Security Level 2
(2)



* GS1 DataBar Limited Security Level 3
(3)



GS1 DataBar Limited Security Level 4
(4)

Composite

Composite CC-C

Parameter # 341 (SSI # F0h 55h)

Scan a barcode below to enable or disable Composite barcodes of type CC-C.



Enable CC-C
(1)



* Disable CC-C
(0)

Composite CC-A/B

Parameter # 342 (SSI # F0h 56h)

Scan a barcode below to enable or disable Composite barcodes of type CC-A/B.



Enable CC-A/B
(1)



* Disable CC-A/B
(0)

Composite TLC-39

Parameter # 371 (SSI # F0h 73h)

Scan a barcode below to enable or disable Composite barcodes of type TLC-39.



Enable TLC39
(1)



* Disable TLC39
(0)

Composite Inverse

Parameter # 1113 (SSI # F8h 04h 59h)

Select an option to set Composite for either regular decode or inverse decode.

- **Regular Only** - The scanner decodes regular Composite barcodes only. Before selecting this, set [Inverse 1D on page 13-70](#) to **Regular Only** or **Inverse Autodetect**.
- **Inverse Only** - The scanner decodes inverse Composite barcodes only. This mode only supports Composite Inverse that includes DataBar combined with CCAB, and does not support other 1D/2D combinations. Before selecting this, first enable [Composite CC-A/B on page 13-75](#), and set [Inverse 1D on page 13-70](#) to **Inverse Only** or **Inverse Autodetect**.



*Regular Only
(0)



Inverse Only
(1)

UPC Composite Mode

Parameter # 344 (SSI # F0h 58h)

Select an option for linking UPC symbols with a 2D symbol during transmission as if they were one symbol:

- Select **UPC Never Linked** to transmit UPC barcodes regardless of whether a 2D symbol is detected.
- Select **UPC Always Linked** to transmit UPC barcodes and the 2D portion. If 2D is not present, the UPC barcode does not transmit.
- If you select **Autodiscriminate UPC Composites**, the digital scanner determines if there is a 2D portion, then transmits the UPC, as well as the 2D portion if present.



* **UPC Never Linked**
(0)



UPC Always Linked
(1)

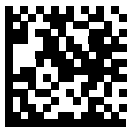

Autodiscriminate UPC Composites
(2)

Composite Beep Mode

Parameter # 398 (SSI # F0h, 8Eh)

To select the number of decode beeps when a composite barcode is decoded, scan the appropriate barcode.



Single Beep after both are decoded
(0)



* Beep as each code type is decoded
(1)



Double Beep after both are decoded
(2)

GS1-128 Emulation Mode for UCC/EAN Composite Codes

Parameter # 427 (SSI # F0h, ABh)

Select whether to enable or disable this mode.

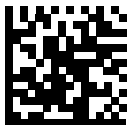

Enable GS1-128 Emulation Mode for
UCC/EAN Composite Codes
(1)



* Disable GS1-128 Emulation Mode for
UCC/EAN Composite Codes
(0)

2D Symbologies

Enable/Disable PDF417

Parameter # 15 (SSI # 0Fh)

To enable or disable PDF417, scan the appropriate barcode below.



* Enable PDF417
(1)



Disable PDF417
(0)

Enable/Disable MicroPDF417

Parameter # 227 (SSI # E3h)

To enable or disable MicroPDF417, scan the appropriate barcode below.



Enable MicroPDF417
(1)



* Disable MicroPDF417
(0)

Code 128 Emulation

Parameter # 123 (SSI # 7Bh)

Enable this parameter to transmit data from certain MicroPDF417 symbols as Code 128. [AIM Code ID Character on page 6-42](#) must be enabled for this parameter to work.

Enable Code 128 Emulation to transmit these MicroPDF417 symbols with one of the following prefixes:

-]C1 if the first codeword is 903-905
-]C2 if the first codeword is 908 or 909
-]C0 if the first codeword is 910 or 911

Disable Code 128 Emulation to transmit these MicroPDF417 symbols with one of the following prefixes:

-]L3 if the first codeword is 903-905
-]L4 if the first codeword is 908 or 909
-]L5 if the first codeword is 910 or 911

Scan a barcode below to enable or disable Code 128 Emulation.



NOTE Linked Micro PDF codewords 906, 907, 912, 914, and 915 are not supported. Use GS1 Composites instead.



Enable Code 128 Emulation
(1)



* Disable Code 128 Emulation
(0)

Data Matrix

Parameter # 292 (SSI # F0h, 24h)

To enable or disable Data Matrix, scan the appropriate barcode below.



* Enable Data Matrix
(1)



Disable Data Matrix
(0)

GS1 Data Matrix

Parameter # 1336 (SSI # F8h 05h 38h)

To enable or disable GS1 Data Matrix, scan the appropriate barcode below.



* Disable GS1 Data Matrix
(0)



Enable GS1 Data Matrix
(1)

Data Matrix Inverse

Parameter # 588 (SSI # F1h 4Ch)

✓ **NOTE** The decoder behaves as if the **Data Matrix Inverse Autodetect** setting is selected if you enable **DPM Mode**.

This parameter sets the Data Matrix inverse decoder setting. Options are:

- **Regular Only** - the digital scanner decodes regular Data Matrix barcodes only.
- **Inverse Only** - the digital scanner decodes inverse Data Matrix barcodes only.
- **Inverse Autodetect** - the digital scanner decodes both regular and inverse Data Matrix barcodes.



Regular
(0)



Inverse Only
(1)



* Inverse Autodetect
(2)

Maxicode

Parameter # 294 (SSI # F0h, 26h)

To enable or disable Maxicode, scan the appropriate barcode below.



Enable Maxicode
(1)



* Disable Maxicode
(0)

QR Code

Parameter # 293 (SSI # F0h, 25h)

✓ **NOTE** Inverse QR barcodes decode if QR Code is enabled.

To enable or disable QR Code, scan the appropriate barcode below.



* Enable QR Code
(1)

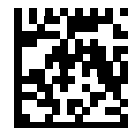

Disable QR Code
(0)

GS1 QR

Parameter # 1343 (SSI # F8h 05h 3Fh)

To enable or disable, scan the appropriate barcode below.



* Disable
(0)



Enable
(1)

MicroQR

Parameter # 573 (SSI # F1h 3Dh)

To enable or disable MicroQR, scan the appropriate barcode below.



* Enable MicroQR
(1)



Disable MicroQR
(0)

Linked QR Mode

Parameter # 1847 (SSI # 737h)

Scan one of the following barcodes to select a linked QR mode:

✓ **NOTE** This parameter applies to all DS36X8 configurations with the exception of the DS36X8-DP and DS36X8-DPA.

- **Linked QR Only** - the digital scanner does not decode individual QR symbols from a set of Linked QR codes.
- **Individual QR With Headers** - the digital scanner decodes individual QR symbols from a set of Linked QR codes and retains the header information and data.
- **Individual QR No Headers** - the digital scanner decodes individual QR symbols from a set of Linked QR codes and transmits the data without header information.

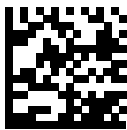

* **Linked QR Only**
(0)



Individual QR With Headers
(1)



Individual QR No Headers
(2)

Aztec

Parameter # 574 (SSI # F1h 3Eh)

To enable or disable Aztec, scan the appropriate barcode below.

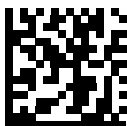

* Enable Aztec
(1)



Disable Aztec
(0)

Aztec Inverse

Parameter # 589 (SSI # F1h 4Dh)

This parameter sets the Aztec inverse decoder setting. Options are:

- **Regular Only** - the digital scanner decodes regular Aztec barcodes only.
- **Inverse Only** - the digital scanner decodes inverse Aztec barcodes only.
- **Inverse Autodetect** - the digital scanner decodes both regular and inverse Aztec barcodes.



Regular
(0)



Inverse Only
(1)



* Inverse Autodetect
(2)

Han Xin

Parameter # 1167 (SSI # F8h 04h 8Fh)

To enable or disable Han Xin, scan the appropriate barcode below.



Enable Han Xin
(1)



* Disable Han Xin
(0)

Han Xin Inverse

Parameter # 1168 (SSI # F8h 04h 90h)

Select a Han Xin inverse decoder setting:

- **Regular Only** - the decoder decodes Han Xin barcodes with normal reflectance only.
- **Inverse Only** - the decoder decodes Han Xin barcodes with inverse reflectance only.
- **Inverse Autodetect** - the decoder decodes both regular and inverse Han Xin barcodes.



* Regular
(0)

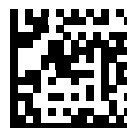

Inverse Only
(1)



Inverse Autodetect
(2)

Grid Matrix

Parameter # 1718 (SSI # F8h 06h B6h)

To enable or disable Grid Matrix, scan one of the following barcodes.

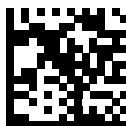

**Enable Grid Matrix
(1)**



***Disable Grid Matrix
(0)**

Grid Matrix Inverse

Parameter # 1719 (SSI # F8h 06h B7h)

Select a Grid Matrix inverse decoder setting:

- **Regular Only** - Digital scanner decodes Grid Matrix barcodes with normal reflectance only.
- **Inverse Only** - Digital scanner decodes Grid Matrix barcodes with inverse reflectance only.
- **Inverse Autodetect** - Digital scanner decodes both regular and inverse Grid Matrix barcodes.



***Regular**
(0)



Inverse Only
(1)

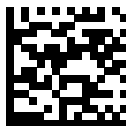

Inverse Autodetect
(2)

Grid Matrix Mirrored

Parameter # 1736 (SSI # F8h 06h C8h)

Select a mirror image Grid Matrix setting:

- **Non-Mirrored Only** - Digital scanner decodes non-mirrored Grid Matrix barcodes only.
- **Mirrored Only** - Digital scanner decodes mirrored Grid Matrix barcodes only.
- **Autodetect** - Digital scanner decodes both mirrored and non-mirrored Grid Matrix barcodes.



***Non-Mirrored Only**
(0)



Mirrored Only
(1)



Mirrored Autodetect
(2)

DotCode**Parameter # 1906 (SSI # F8 07 72h)**

✓ **NOTE** This parameter is only supported on the SR and HD configurations.

Scan one of the following barcodes to enable or disable DotCode.



*** Disable DotCode
(0)**



**Enable DotCode
(1)**

DotCode Inverse

Parameter # 1907 (SSI # F8 07 73h)

✓ **NOTE** This parameter is only supported on the SR and HD configurations.

Scan one of the following barcodes to select a DotCode Inverse decoder setting. Setting options are:

- **Regular Only** - Decoder decodes DotCode barcodes with normal reflectance only.
- **Inverse Only** - Decoder decodes DotCode barcodes with inverse reflectance only.
- **Inverse Autodetect** - Decoder decodes both regular and inverse DotCode barcodes.



Regular
(0)



Inverse Only
(1)



*** Autodetect**
(2)

DotCode Mirrored

Parameter # 1908 (SSI # F8 07 74h)

✓ **NOTE** This parameter is only supported on the SR and HD configurations.

Scan one of the following barcodes to select a DotCode Mirror decoder setting:

- **Non-Mirrored Only** - Digital scanner decodes non-mirrored DotCode barcodes only.
- **Mirrored Only** - Digital scanner decodes mirrored DotCode barcodes only.
- **Autodetect** - Digital scanner decodes both mirrored and non-mirrored DotCode barcodes.



Never
(0)



Always
(1)

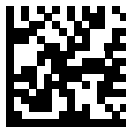

*** Autodetect**
(2)

DotCode Prioritize

Parameter # 1937 (SSI # F8 07 91h)

✓ **NOTE** This parameter is only supported on the SR and HD configurations.

Enable DotCode Prioritize to give priority to DotCode decoding as compared to other symbologies.



* Disable



Enable

Postal Codes

US Postnet

Parameter # 89 (SSI # 59h)

To enable or disable US Postnet, scan the appropriate barcode below.



Enable US Postnet
(1)



* Disable US Postnet
(0)

US Planet

Parameter # 90 (SSI # 5Ah)

To enable or disable US Planet, scan the appropriate barcode below.



Enable US Planet
(1)



* Disable US Planet
(0)

Transmit US Postal Check Digit

Parameter # 95 (SSI # 5Fh)

Select whether to transmit US Postal data, which includes both US Postnet and US Planet, with or without the check digit.



* Transmit US Postal Check Digit
(1)



Do Not Transmit US Postal Check Digit
(0)

UK Postal

Parameter # 91 (SSI # 5Bh)

To enable or disable UK Postal, scan the appropriate barcode below.



Enable UK Postal
(1)



* Disable UK Postal
(0)

Transmit UK Postal Check Digit

Parameter # 96 (SSI # 60h)

Select whether to transmit UK Postal data with or without the check digit.



* Transmit UK Postal
Check Digit
(1)



Do Not Transmit UK Postal Check Digit
(0)

Japan Postal

Parameter # 290 (SSI # F0h, 22h)

To enable or disable Japan Postal, scan the appropriate barcode below.



Enable Japan Postal
(1)



* Disable Japan Postal
(0)

Australia Post

Parameter # 291 (SSI # F0h, 23h)

To enable or disable Australia Post, scan the appropriate barcode below.



Enable Australia Post
(1)



* Disable Australia Post
(0)

Australia Post Format

Parameter # 718 (SSI # F1h, CEh)

To select one of the following formats for Australia Post, scan the appropriate barcode below:

- **Autodiscriminate** (or Smart mode) - Attempt to decode the Customer Information Field using the N and C Encoding Tables.

✓ **NOTE** This option increases the risk of misdecodes because the encoded data format does not specify the Encoding Table used for encoding.

- **Raw Format** - Output raw bar patterns as a series of numbers 0 through 3.
- **Alphanumeric Encoding** - Decode the Customer Information Field using the C Encoding Table.
- **Numeric Encoding** - Decode the Customer Information Field using the N Encoding Table.

For more information on Australia Post Encoding Tables, refer to the *Australia Post Customer Barcoding Technical Specifications* available at <http://auspost.com.au>.

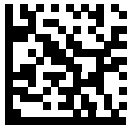

* Autodiscriminate
(0)



Raw Format
(1)



Alphanumeric Encoding
(2)



Numeric Encoding
(3)

Netherlands KIX Code

Parameter # 326 (SSI # F0h, 46h)

To enable or disable Netherlands KIX Code, scan the appropriate barcode below.



Enable Netherlands KIX Code
(1)



* Disable Netherlands KIX Code
(0)

USPS 4CB/One Code/Intelligent Mail

Parameter # 592 (SSI # F1h 50h)

To enable or disable USPS 4CB/One Code/Intelligent Mail, scan the appropriate barcode below.



Enable USPS 4CB/One Code/Intelligent Mail
(1)



* Disable USPS 4CB/One Code/Intelligent Mail
(0)

UPU FICS Postal

Parameter # 611 (SSI # F1h 63h)

To enable or disable UPU FICS Postal, scan the appropriate barcode below.



Enable UPU FICS Postal
(1)



* Disable UPU FICS Postal
(0)

Mailmark

Parameter # 1337 (SSI # F8h 05h 39h)

To enable or disable Mailmark, scan the appropriate barcode below.



* Disable Mailmark
(0)



Enable Mailmark
(1)

Symbology-Specific Security Levels

Redundancy Level

Parameter # 78 (SSI # 4Eh)

The digital scanner offers four levels of decode redundancy. Select higher redundancy levels for decreasing levels of barcode quality. As redundancy levels increase, the digital scanner's aggressiveness decreases.

Select the redundancy level appropriate for the barcode quality.

Redundancy Level 1

The following code types must be successfully read twice before being decoded:

Table 13-2 *Redundancy Level 1 Codes*

Code Type	Code Length
Codabar	8 characters or less
MSI	4 characters or less
D 2 of 5	8 characters or less
I 2 of 5	8 characters or less

Redundancy Level 2

The following code types must be successfully read twice before being decoded:

Table 13-3 *Redundancy Level 2 Codes*

Code Type	Code Length
All	All

Redundancy Level 3

Code types other than the following must be successfully read twice before being decoded. The following codes must be read three times:

Table 13-4 *Redundancy Level 3 Codes*

Code Type	Code Length
MSI	4 characters or less
D 2 of 5	8 characters or less
I 2 of 5	8 characters or less
Codabar	8 characters or less

Redundancy Level 4

The following code types must be successfully read three times before being decoded:

Table 13-5 *Redundancy Level 4 Codes*

Code Type	Code Length
All	All

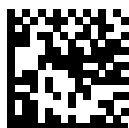

* Redundancy Level 1
(1)



Redundancy Level 2
(2)

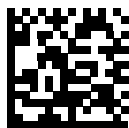

Redundancy Level 3
(3)



Redundancy Level 4
(4)

Security Level

Parameter # 77 (SSI # 4Dh)

The digital scanner offers four levels of decode security for delta barcodes, which include the Code 128 family, UPC/EAN, and Code 93. Select increasing levels of security for decreasing levels of barcode quality. There is an inverse relationship between security and digital scanner aggressiveness, so choose only that level of security necessary for any given application.

- **Security Level 0:** This setting allows the digital scanner to operate in its most aggressive state, while providing sufficient security in decoding most “in-spec” barcodes.
- **Security Level 1:** This default setting eliminates most misdecodes.
- **Security Level 2:** Select this option if Security level 1 fails to eliminate misdecodes.
- **Security Level 3:** If you selected Security Level 2 and misdecodes still occur, select this security level. Be advised, selecting this option is an extreme measure against mis-decoding severely out of spec barcodes. Selecting this level of security significantly impairs the decoding ability of the digital scanner. If you need this level of security, try to improve the quality of the barcodes.



Security Level 0
(0)



* Security Level 1
(1)



Security Level 2
(2)



Security Level 3
(3)

1D Quiet Zone Level

Parameter # 1288 (SSI # F8h 05h 08h)

This feature sets the level of aggressiveness in decoding barcodes with a reduced quiet zone (the area in front of and at the end of a barcode), and applies to symbologies enabled by a Reduced Quiet Zone parameter. Because higher levels increase the decoding time and risk of misdecodes, Symbol Technologies strongly recommends enabling only the symbologies which require higher quiet zone levels, and leaving Reduced Quiet Zone disabled for all other symbologies. Options are:

- 0 - The digital scanner performs normally in terms of quiet zone.
- 1 - The digital scanner performs more aggressively in terms of quiet zone.
- 2 - The digital scanner only requires one side EB (end of barcode) for decoding.
- 3 - The digital scanner decodes anything in terms of quiet zone or end of barcode.



1D Quiet Zone Level 0
(0)



* 1D Quiet Zone Level 1
(1)

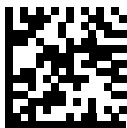

1D Quiet Zone Level 2
(2)



1D Quiet Zone Level 3
(3)

Intercharacter Gap Size

Parameter # 381 (SSI # F0h, 7Dh)

The Code 39 and Codabar symbologies have an intercharacter gap that is typically quite small. Due to various barcode-printing technologies, this gap can grow larger than the maximum size allowed, preventing the digital scanner from decoding the symbol. If this problem occurs, scan the **Large Intercharacter Gaps** parameter to tolerate these out-of-specification barcodes.



* Normal Intercharacter Gaps
(6)



Large Intercharacter Gaps
(10)

Report Version

Scan the barcode below to report the version of software installed in the digital scanner.



Report Software Version

Macro PDF Features

Macro PDF is a special feature for concatenating multiple PDF symbols into one file. The digital scanner can decode symbols that are encoded with this feature, and can store more than 64 Kb of decoded data stored in up to 50 Macro PDF symbols.



CAUTION When printing, keep each Macro PDF sequence separate, as each sequence has unique identifiers. Do not mix barcodes from several Macro PDF sequences, even if they encode the same data. When scanning Macro PDF sequences, scan the entire Macro PDF sequence without interruption. If, when scanning a mixed sequence, the digital scanner emits two long low beeps (Low/Low) this indicates an inconsistent file ID or inconsistent symbology error.

Flush Macro Buffer

This flushes the buffer of all decoded Macro PDF data stored to that point, transmits it to the host device, and aborts from Macro PDF mode.



Flush Macro PDF Buffer

Abort Macro PDF Entry

This clears all currently-stored Macro PDF data in the buffer without transmission and aborts from Macro PDF mode.



Abort Macro PDF Entry

CHAPTER 14 INTELLIGENT DOCUMENT CAPTURE

Introduction

Intelligent Document Capture (IDC) is Zebra advanced image processing firmware for select imager based decoders. This chapter describes the IDC functionality, provides parameter barcodes to control its features, and includes a quick start procedure to get you started with IDC.



NOTE IDC pertains to the DS36X8-HP configuration only.

For the DS3678-HP with Display and Keypad, documents and decoded data displays on the host (not on the device display).

The IDC Process

Intelligent Document Capture:

1. Verifies a barcode is appropriate to use as an IDC anchor or link. See [Bar Code Acceptance Test](#).
2. Determines the rectangular region to capture as an image. See [Capture Region Determination on page 14-2](#).
3. Processes the captured image. See [Image Post Processing on page 14-3](#).
4. Transmits the data. See [Data Transmission on page 14-3](#).

Bar Code Acceptance Test

Upon decoding a barcode, the decoder checks to ensure that the barcode fits the description of a barcode that anchors or links to an IDC form. To be accepted as an IDC barcode:

- The symbology must be enabled in the IDC symbology parameter and enabled for decode in the decoder. The IDC firmware allows enabling between zero and eight symbologies simultaneously: Code 128, Code 39, Interleaved 2 of 5, Discrete 2 of 5, Codabar, PDF417, Data Matrix, and EAN-128.
- The decoded data must satisfy the values set in the *IDC Minimum Text Length* and *IDC Maximum Text Length* parameters. To disable either of these checks, set the value to zero.

If the barcode does not satisfy both requirements, it is sent as a normal (non-IDC) decode.

An IDC barcode is required when *IDC Operating Mode on page 14-5* is set to **Anchored** or **Linked**.

Free-Form operating mode does not require a barcode, but transmits decoded data if one is found and satisfies the requirements. If no barcode is decoded, the document capture process starts but can be subject to the following condition: specify a non-zero value for the *IDC Delay Time on page 14-18*. The decoder must wait for at least this amount of time after trigger pull before capturing a document, unless a barcode is decoded before the time expires.

If *Picklist Mode on page 6-26* is enabled, the barcode must be directly under the aiming pattern, within the decoder's decode range, and the region to capture completely within the engine's field-of-view.

Capture Region Determination

After accepting an IDC barcode, the firmware establishes the region to capture as an image. The method used depends on the setting of the *IDC Operating Mode* as follows.

The IDC firmware emits a single low beep after successfully capturing a region. The engine is then no longer capturing images and can be moved without disturbing the IDC output. Be sure to hold the trigger button until the decode beep, otherwise the IDC process may be aborted.

IDC Operating Mode = Anchored

A coordinate system is built based on the barcode in its rectified (de-skewed) form. The origin is the center of the barcode, and the x-axis is set toward the right, from the barcode's point of view. The unit module width of the barcode is the unit for x. Similarly, the y-axis is set toward the up direction. The unit for the y-axis is specified via the parameter *IDC Aspect on page 14-9*. This is the aspect ratio of a thin bar or space - the barcode's height is divided by this value to get the unit in the y-axis. The aspect ratio is calculated automatically if *IDC Aspect* is set to zero. The barcode can be of different sizes for the same form, as long as the center of the barcode is the same when the barcode's length changes.

From this coordinate system, the IDC area is determined using four parameters: offsets in x and y (*IDC X Coordinate*, *IDC Y Coordinate*) to the region's top-left corner, and width and height (*IDC Width*, *IDC Height*).

If the capture area is relatively large as compared to the barcode area, the calculation to obtain the capture area is prone to significant errors. A recommended solution is to enclose the form with a single black-lined rectangular border (a box), which is not in contact with any other line on the outside of the form (although it can be connected to lines on the inside of the form). When the *IDC Find Box Outline* is set, the firmware searches for the box, and does not decode if any edges are broken (such as by a protruding thumb).

The *IDC Zoom Limit* parameter controls the quality of the captured form. The IDC firmware rejects capturing a form unless the width is at least the *IDC Zoom Limit* percentage of the *IDC Width* parameter. For example, if *IDC Zoom Limit* is set to 100 and *IDC Width* is set to 150, the form must be at least 300 pixels wide before it is captured (each unit module is scaled to two pixels).

The *IDC Maximum Rotation* parameter controls the maximum rotation any edge of the form can have in relation to the scanner's horizontal or vertical axis.

IDC Operating Mode = Free-Form or Linked

The document capture region is a rectangular piece of paper, or a portion of it enclosed by a rectangular border. In either case, all four sides of the capture region must be completely within the engine's field-of-view, and there must be sufficient contrast at the border of the capture region. For example, if a piece of white paper contains the document to capture, it must be put in front of a dark background.

By default, the engine captures the largest rectangular region within the field-of-view. To specify a particular border type, use the *IDC Border Type* parameter.

The region must contain at least 10% of the field-of-view in two dimensions.

If an IDC barcode is decoded, its location is used to start the search for the capture region. Otherwise, the capture region is searched from the center of the field-of-view. IDC also uses the orientation of a decoded IDC barcode to orient the output image.

Image Post Processing

After determining the document capture region, the firmware de-skews and re-samples the region as described below. Enabling *IDC Captured Image Brighten* calls normalization, where the brightness of the image is made uniform, and contrast is enhanced as a large percent of background pixels is made completely white (a smaller percent of pixels is made completely black if the firmware determines there is no danger of enhancing the contrast of a very bland area). Enabling *IDC Captured Image Sharpen* enhances the sharpness of the image.

The image is re-sampled about one output pixel per input pixel for **Free-Form** or **Linked** modes and two pixels-per-module in **Anchored** mode.

The image is compressed and transmitted in one of the standard image formats selected by the *IDC File Format Selector*, *IDC Bits Per Pixel*, and *IDC JPEG Quality* parameters.

Note that it may take several seconds for post processing to complete, depending on the size of the captured region, the options enabled, and the decoder model.

Data Transmission

After processing the captured image, it is assembled with the decoded barcode data (if applicable) into an ISO/IEC 15434 style packet and transmitted to the host. The decoder issues the standard decode beep and the trigger can be released. Be sure the *USB Device Type on page 8-5* is set to **Symbol Native API (SNAPI) with Imaging Interface**.

PC Application and Programming Support

For a sample application running on the Microsoft Windows operating system, contact your Zebra representative. This application displays barcode data and/or captured images from Intelligent Document Capture enabled decoders and allows setting and reading IDC parameters. Complete source code and documentation are also provided for developing custom applications. The application includes documentation for the ISO/IEC 15434 format as used by the IDC firmware and C# code to process it.

Parameters

✓ **NOTE** IDC pertains to the DS36X8-HP configuration only.

This section describes the parameters controlling the IDC firmware and provides programming barcodes for setting them.

To set parameters requiring a range of values, scan the parameter barcode followed by two, three, or four barcodes from [Appendix H, Numeric Bar Codes](#) corresponding to the desired value. Scan two numeric barcodes for parameters with a maximum value of less than 100, for example, [IDC Minimum Text Length](#). [IDC Delay Time](#) requires scanning three digits since the maximum value is 200. Leading zeros are required.

Alternatively, use the sample application to set parameters using the parameter name. The application provides prompts and error checking to assist in setting the parameters correctly and easily. You must use an application to set a parameter to a negative value, as the [IDC X Coordinate](#) can require.

Table 14-1 *Intelligent Document Capture (IDC) Parameter Defaults*

Parameter	Parameter Name	Parameter Number	SSI Number	Default	Page Number
Intelligent Document Capture (IDC)					
IDC Operating Mode	DocCap_MODE	594	F1h 52h	Off	14-5
IDC Symbology	DocCap_SYMBOLOGY	655	F1h 8Fh	001	14-6
IDC X Coordinate	DocCap_X	596	F4h F1h 54h	-151	14-7
IDC Y Coordinate	DocCap_Y	597	F4h F1h 55h	-050	14-7
IDC Width	DocCap_WIDTH	598	F1h 56h	0300	14-8
IDC Height	DocCap_HEIGHT	599	F1h 57h	0050	14-8
IDC Aspect	DocCap_ASPECT	595	F1h 53h	000	14-9
IDC File Format Selector	DocCap_FMT	601	F1h 59h	JPEG	14-10
IDC Bits Per Pixel	DocCap_BPP	602	F1h 5Ah	8 BPP	14-11
IDC JPEG Quality	DocCap_JPEG_Qual	603	F1h 5Bh	065	14-12
IDC Find Box Outline	Sig_FINDBOX	727	F1h D7h	Disable	14-12
IDC Minimum Text Length	DocCap_MIN_TEXT	656	F1h 90h	00	14-13
IDC Maximum Text Length	DocCap_MAX_TEXT	657	F1h 91h	00	14-14
IDC Captured Image Brighten	Sig_BRIGHTEN	654	F1h 8Eh	Enable	14-15
IDC Captured Image Sharpen	Sig_SHARPEN	658	F1h 92h	Enable	14-16
IDC Border Type	DocCap_BORDER	829	F2h 3Dh	None	14-17
IDC Delay Time	DocCap_DELAY	830	F2h 3Eh	000	14-18
IDC Zoom Limit	Sig_MIN_PERCENT	651	F1h 8Bh	000	14-18
IDC Maximum Rotation	Sig_MAX_ROT	652	F1h 8Ch	00	14-19

IDC Operating Mode

Parameter Name: DocCap_MODE

Parameter # 594 (SSI # F1h 52h)

✓ **NOTE** IDC pertains to the DS36X8-HP configuration only.

Select the operating mode of the Intelligent Document Capture firmware:

- **Off** - Disables the IDC feature.
- **Anchored** - Requires a barcode decode. The image capture region is based off this barcode.
- **Free-Form** - A printed border or page edge defines the image capture region. A barcode is optional.
- **Linked** - A printed border or page edge defines the image capture region. A barcode is required.

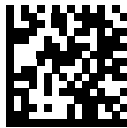

* Off
(0)



Anchored
(1)

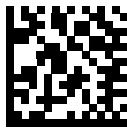

Free-Form
(2)



Linked
(3)

IDC Symbology

Parameter Name: DocCap_SYMBOLOGY

Parameter # 655 (SSI # F1h 8Fh)

✓ **NOTE** IDC pertains to the DS36X8-HP configuration only.

Select the barcode type(s) to use when Document Capture mode is not set to **Off**. To enable more than one symbology at a time, simply add the values together. For example, to enable PDF417, Data Matrix, and Code 39 write a value of 98 (32 + 64 + 2).

Scan the barcode below, followed by three barcodes from [Appendix H, Numeric Bar Codes](#) in the range of 000 to 999 decimal. The default is 001.

Table 14-2 *IDC Symbologies*

Symbology	Value (Decimal)
Code 128	1
Code 39	2
I 2 of 5	4
D 2 of 5	8
Codabar	16
PDF417	32
Data Matrix	64
EAN 128	128
Aztec	256

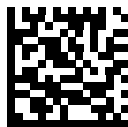

IDC Symbology

IDC X Coordinate

Parameter Name: DocCap_X

Parameter # 596 (SSI # F4h F1h 54h)

✓ **NOTE** IDC pertains to the DS36X8-HP configuration only.

Specify the horizontal offset to the top left corner of the region to capture relative to the center of the barcode. Negative values move toward the left. This parameter only applies when *IDC Operating Mode* is set to **Anchored**.

Scan the barcode below, followed by four barcodes from *Appendix H, Numeric Bar Codes* in the range of +/- 1279. The default is -151. Note that you must use an application to set a negative value.



IDC X Coordinate

IDC Y Coordinate

Parameter Name: DocCap_Y

Parameter # 597 (SSI # F4h F1h 55h)

✓ **NOTE** IDC pertains to the DS36X8-HP configuration only.

Specify the vertical offset to the top left corner of the region to capture relative to the center of the barcode. Negative values move toward the top. This parameter only applies when *IDC Operating Mode* is set to **Anchored**.

Scan the barcode below, followed by four barcode from *Appendix H, Numeric Bar Codes* in the range of +/- 1023. The default is -050. Note that you must use an application to set a negative value.



IDC Y Coordinate

IDC Width

Parameter Name: DocCap_WIDTH

Parameter # 598 (SSI # F1h 56h)

✓ **NOTE** IDC pertains to the DS36X8-HP configuration only.

Specify the width of the region to capture. This parameter only applies when *IDC Operating Mode* is set to **Anchored**.

Scan the barcode below, followed by four barcodes from *Appendix H, Numeric Bar Codes* in the range of 0000 to 1279. The default is 0300.



IDC Width

IDC Height

Parameter Name: DocCap_HEIGHT

Parameter # 599 (SSI # F1h 57h)

✓ **NOTE** IDC pertains to the DS36X8-HP configuration only.

Specify the height of the region to capture. This parameter only applies when *IDC Operating Mode* is set to **Anchored**.

Scan the barcode below, followed by four barcodes from *Appendix H, Numeric Bar Codes* in the range of 0000 to 1279. The default is 0050.



IDC Height

IDC Aspect

Parameter Name: DocCap_ASPECT

Parameter # 595 (SSI # F1h 53h)

✓ **NOTE** IDC pertains to the DS36X8-HP configuration only.

Specify the barcode's aspect ratio of a thin bar or space. The barcode's height is divided by this value to get the unit in the y-axis. The aspect value is calculated automatically if this parameter is set to zero.

This parameter only applies when *IDC Operating Mode* is set to **Anchored**.

Scan the barcode below, followed by three barcodes from *Appendix H, Numeric Bar Codes* in the range of 000 to 255. The default is 000.



IDC Aspect

IDC File Format Selector

Parameter Name: DocCap_FMT

Parameter # 601 (SSI # F1h 59h)

✓ **NOTE** IDC pertains to the DS36X8-HP configuration only.

Select a document capture file format appropriate for your system (BMP, TIFF, or JPEG). The decoder stores captured areas in the selected format.



* JPEG
(1)



BMP
(3)



TIFF
(4)

IDC Bits Per Pixel

Parameter Name: DocCap_BPP

Parameter # 602 (SSI # F1h 5Ah)

✓ **NOTE** IDC pertains to the DS36X8-HP configuration only.

Select the number of significant bits per pixel (BPP) to use when capturing an image. Select 1 BPP for a black and white image, 4 BPP to assign 1 of 16 grey levels to each pixel, or 8 BPP to assign 1 of 256 levels of grey to each pixel.

✓ **NOTE** The decoder ignores these settings for JPEG file formats, which only support 8 BPP.

1 BPP



(0)



4 BPP
(1)

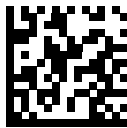

* 8 BPP
(2)

IDC JPEG Quality

Parameter Name: DocCap_JPEG_Qual

Parameter # 603 (SSI # F1h 5Bh)

✓ **NOTE** IDC pertains to the DS36X8-HP configuration only.

Set the amount of JPEG compression to perform on the captured image. Higher numbers produce a better quality image but larger files.

Scan the barcode below, followed by three barcodes from [Appendix H, Numeric Bar Codes](#) in the range of 005 to 100 decimal. The default is 065.



IDC JPEG Quality

IDC Find Box Outline

Parameter Name: Sig_FINDBOX

Parameter # 727 (SSI # F1h D7h)

✓ **NOTE** IDC pertains to the DS36X8-HP configuration only.

Select **Enable Find Box Outline** to instruct the firmware to search for a rectangular border during document capture. This parameter only applies when [IDC Operating Mode](#) is set to **Anchored**.



* **Disable Find Box Outline**
(0)



Enable Find Box Outline
(1)

IDC Minimum Text Length

Parameter Name: DocCap_MIN_TEXT

Parameter # 656 (SSI # F1h 90h)

✓ **NOTE** IDC pertains to the DS36X8-HP configuration only.

Specify the minimum number of characters encoded in a barcode for the IDC firmware to use it as an anchored or linked barcode. Set this to zero (the default) to disable all checking and use all barcodes.

Scan the barcode below, followed by two barcodes from [Appendix H, Numeric Bar Codes](#) in the range of 00 to 55 decimal. The default is 00.



IDC Minimum Text Length

IDC Maximum Text Length

Parameter Name: DocCap_MAX_TEXT

Parameter # 657 (SSI # F1h 91h)

✓ **NOTE** IDC pertains to the DS36X8-HP configuration only.

Specify the maximum number of characters encoded in a barcode for the IDC firmware to use it as an anchored or linked barcode. Set this to zero (the default) to disable all checking and use all barcodes.

Scan the barcode below, followed by two barcodes from [Appendix H, Numeric Bar Codes](#) in the range of 00 to 55 decimal. The default is 00.



IDC Maximum Text Length

IDC Captured Image Brighten

Parameter Name: Sig_BRIGHTEN

Parameter # 654 (SSI # F1h 8Eh)

Enable **Captured Image Brighten** to make image brightness uniform and enhance contrast such that a large percent of the background pixels is made completely white (a smaller percentage of pixels is made completely black if the program determines there is no danger of enhancing the contrast of a very bland area).

✓ **NOTE** This parameter is also used for Signature Capture.

✓ **NOTE** IDC pertains to the DS36X8-HP configuration only.



Disable Captured Image Brighten
(0)

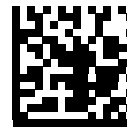

* Enable Captured Image Brighten
(1)

IDC Captured Image Sharpen

Parameter Name: Sig_SHARPEN

Parameter # 658 (SSI # F1h 92h)

Enable this to enhance the sharpness of the image.

✓ **NOTE** This parameter is also used for Signature Capture.

✓ **NOTE** IDC pertains to the DS36X8-HP configuration only.



Disable Captured Image Sharpen
(0)

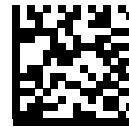

*** Enable Captured Image Sharpen**
(1)

IDC Border Type

Parameter Name: DocCap_BORDER

Parameter # 829 (SSI # F2h 3Dh)

✓ **NOTE** IDC pertains to the DS36X8-HP configuration only.

Select the style of border used to determine the outline of the capture region in **Free-Form** and **Linked** modes:

- Select **None** to capture the largest rectangular region within the field-of-view.
- Select **Black** to indicate that the border must be black (such as a printed rectangular border).
- Select **White** to indicate that the border must be white (e.g., paper edge on a dark background).
- Select **Advanced Edge Detection (AED)** to capture a region defined by edges of any color and potentially broken.

This parameter is only used in **Free-Form** and **Linked** modes.

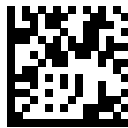

* None
(0)



Black
(1)



White
(2)



Advanced Edge Detection (AED)
(3)

IDC Delay Time

Parameter Name: DocCap_DELAY

Parameter # 830 (SSI # F2h 3Eh)

✓ **NOTE** IDC pertains to the DS36X8-HP configuration only.

Set the delay for capturing a document after a trigger pull. Decoding a barcode aborts this delay. This parameter only applies in **Free-Form** mode.

Scan the barcode below, followed by three barcodes from [Appendix H, Numeric Bar Codes](#) in the range of 000 to 200 decimal in units of 10 msec. The default is 000.



IDC Delay Time

IDC Zoom Limit

Parameter Name: Sig_MIN_PERCENT

Parameter # 651 (SSI # F1h 8Bh)

✓ **NOTE** IDC pertains to the DS36X8-HP configuration only.

Set the minimal "zoom" percentage value of a form for it to be considered for capture. This controls the quality of the captured form. The IDC firmware rejects capturing a form unless the width is at least the [IDC Zoom Limit](#) percentage of the [IDC Width](#) parameter. For example, if you set this parameter to 100 and [IDC Width](#) to 150, the form must be at least 300 pixels wide before it is captured (each unit module is scaled to two pixels).

Set this to zero (the default) to disable all checking. This parameter only applies in **Anchored** mode.

Scan the barcode below, followed by three barcodes from [Appendix H, Numeric Bar Codes](#) in the range of 000 to 100 percent. The default is 000.



IDC Zoom Limit

IDC Maximum Rotation

Parameter Name: Sig_MAX_ROT

Parameter # 652 (SSI # F1h 8Ch)

✓ **NOTE** IDC pertains to the DS36X8-HP configuration only.

Set the maximum rotation any edge of the form can have in relation to the decoder's horizontal or vertical axis for it to be considered for capture. Set this to zero (the default) to disable all checking. This parameter only applies in **Anchored** mode.

Scan the barcode below, followed by two barcodes from [Appendix H, Numeric Bar Codes](#) in the range of 00 to 45 decimal. The default is 00.



IDC Maximum Rotation

Quick Start

This section familiarizes you with some of the Intelligent Document Capture features. [IDC Demonstrations on page 14-21](#) includes instructions to demonstrate the Anchored, Free-Form, and Linked modes using a sample form to help provide an understanding of how to use IDC. These examples do not illustrate all capabilities of the advanced IDC firmware. Build upon these using different parameter settings and forms.

Sample IDC Setup

To set up IDC with the decoder:

1. Connect a decoder equipped with the Intelligent Document Capture feature to the host computer's USB port.
2. To set the decoder to the default settings and proper USB host type, scan **Set Defaults** followed by the **Symbol Native API (SNAPI) with Imaging Interface** barcode. Allow time for the decoder to reset and the USB connection to remunerate after each scan before continuing.



Set Defaults



Symbol Native API (SNAPI) with Imaging Interface

3. Start the sample application and select the decoder in the **SNAPI Scanners** drop-down menu.
4. Set the parameters as specified in [IDC Demonstrations on page 14-21](#) using the sample application or by scanning parameter barcodes in this guide. The barcode in the sample form is Code 128, which is enabled by default for decoding and as a Document Capture symbology. You can change these settings for your IDC application.
5. Perform the list of suggestions in each demo. When scanning, aim the engine at the barcode in the center of the rectangle. Pull the engine back so the rectangle is fully contained in the aiming pattern. When you pull the trigger, the decoder emits a low tone to indicate that the IDC firmware identified and captured an image, then a decode beep to indicate that the data is processed and transmitted. There may be several seconds between the two beeps, depending on the size of the captured image and options selected (de-skew, brighten, etc). You can move the decoder after the first beep, but continue to hold the trigger or the decoder may end the session before sending the data.

IDC Demonstrations

Anchored Mode Demo

Set parameters to these values:

Table 14-3 *Anchored Mode Sample Parameter Values*

Parameter	Value
IDC Operating Mode	Anchored
IDC Height	100
IDC Width	90
IDC X Coordinate	-175
IDC Y Coordinate	-50

- Pull the trigger. The decoder decodes the barcode and captures an image of the text scroll.
- Rotate the form clockwise so the word **Capture** is along the bottom edge, and pull the trigger. The decoder decodes the barcode and captures the same image, including orientation. (This example also works with the form rotated counterclockwise or upside down).
- Modify the values for height, width, x, and y. Pull the trigger. The captured area changes in size and location.
- Cover the barcode with a small piece of paper (or your finger) and pull the trigger. The decoder does not decode the barcode or capture an image.

What this demonstrates:

The Intelligent Document Capture Anchored mode captures an image of fixed size and location relative to a barcode on the page. Parameters control the height, width, and location. The IDC firmware requires that a barcode is present in order to capture an image, decodes it, and uses it to adjust the image to the upright orientation.

Free-Form Mode Demo

Set IDC Operating Mode to **Free-Form**.

- Pull the trigger. The decoder decodes the barcode and captures an image of the entire rectangle, including the contents.
- Modify the values for height, width, x, and y. Pull the trigger. Note that the captured image is not affected.
- Rotate the form clockwise so the word **Capture** is along the bottom edge, and pull the trigger. The decoder decodes the barcode and captures the same image, including orientation. (This example also works with the form rotated counterclockwise or upside down).
- Cover the barcode with a small piece of paper and pull the trigger. The decoder does not decode the barcode and does not re-orient the captured image to the normal position, i.e., with the logo in upper-left corner.

What this demonstrates:

The Intelligent Document Capture Free-Form mode captures an image whose size and position are determined by a rectangular border on the page. It adjusts the image to the upright orientation if a barcode is found and decoded in the image.

Linked Mode Demo

Set IDC Operating Mode to **Linked**.

The examples from Free-Form mode also work in Linked mode except that the last one (with the barcode covered) does not decode the barcode or capture an image.

What this demonstrates:

The Intelligent Document Capture Linked mode captures an image whose size and position are determined by a rectangular border on the page. The IDC firmware requires that a barcode is present in order to capture an image, decodes it, and uses it to adjust the image to the upright orientation

Other Suggestions

Hold the decoder at an angle (up/down or side to side) to the page instead of perpendicular to it. The IDC firmware de-skews and adjusts the brightness (enabled by default) to produce a quality image when the decoder is held at less than ideal conditions.

Quick Start Form

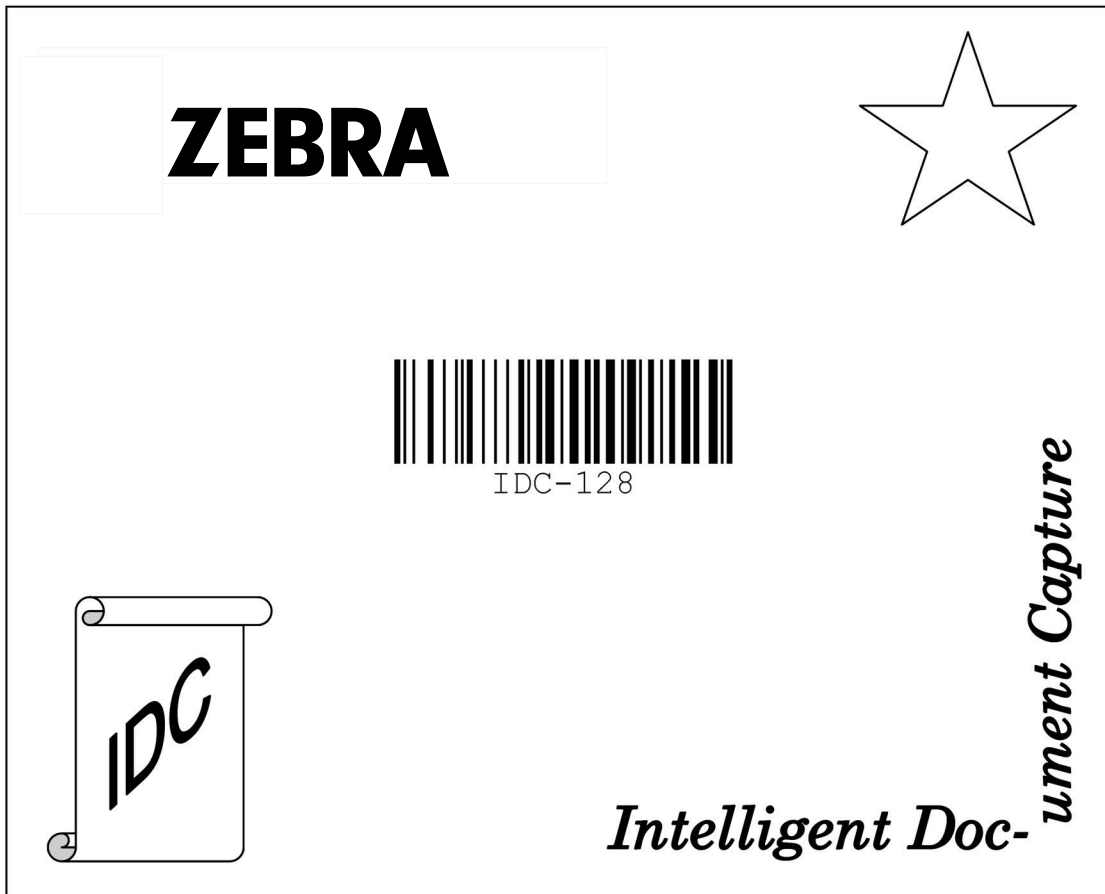

Figure 14-1 Quick Start Form

CHAPTER 15 DIGIMARC BARCODE

Introduction

Digimarc Barcode is an invisible machine-readable code.

✓ **NOTE** This feature only applies to the DS36x8-SR and DS36x8-ER configurations.

Digimarc Symbology

Digimarc codes are reported as UPC-A, UPC-E, EAN-13, or GS1 DataBar Expanded.

✓ **NOTE** Converting the Digimarc reported code types to other barcode types is not supported.

AIM and Symbol code IDs are supported for the reported Digimarc code types.

Picklist

The Digimarc decoder searches configured block areas of the image for Digimarc codes, and operates the same regardless of whether [Picklist Mode on page 6-26](#) is enabled or disabled.

✓ **NOTE** Decode time can be greater in [Picklist Mode](#) due to the additional processing required by the system and decoder.

Digimarc Digital Watermarks

Parameter # 1687 (SSI # F8h 06h 97h)

Scan the appropriate barcode to enable or disable the Digimarc Digital Watermarks code.



**Enable Digimarc Digital Watermarks
(1)**



***Disable Digimarc Digital Watermarks
(0)**

CHAPTER 16 DATA FORMATTING: ADF, MDF, PREFERRED SYMBOL

Introduction

This chapter briefly describes the Zebra features available for customizing scanner operation.

Advanced Data Formatting (ADF)

Advanced Data Formatting (ADF) is a means of customizing data from before transmission to the host device. Use ADF to edit scan data to suit your host's requirements. With ADF you scan one barcode per trigger pull. ADF is programmed using 123Scan.

To watch a video on Creating an Advanced Data Formatting (ADF) Rule using 123Scan, go to: <http://zebra.com/ScannerHowToVideos>

For additional information, refer to the *Advanced Data Formatting Programmer Guide*.

Multicode Data Formatting (MDF)

Multicode Data Formatting (MDF) enables a 2D imaging scanner to scan all barcodes on a label with a single trigger pull, and then modify and transmit the data to meet host application requirements. MDF supports programming up to nine unique labels into one scanner. MDF also supports scanning multiple barcodes on opposite sides of a box by holding the trigger.

Programming options include:

- Output all or specific barcodes
- Control the barcode output sequence
- Apply unique multicode data formatting (MDF) to each output barcode
- Discard scanned data if all required barcodes are not present

For more information, refer to the *MDF and Preferred Symbol User Guide*.

To watch a video on Creating an Multicode Data Formatting (MDF) Rule using 123Scan, go to: <http://zebra.com/ScannerHowToVideos>

MDF in Hands-Free Mode

MDF in a hands-free scanning mode may yield multiple unexpected and undesired outputs when a label (most likely on a complex label) passes through the scanner's field of view. This problem happens when the complex label's barcodes can be matched by more than one group (for example, Group 1 represents all barcodes present and Group 2 represent some barcodes present).

- ✓ **NOTE** A similar problem can also occur in the hand-held trigger mode. If multiple MDF rules/groups exist and all the label is not in the field of view when pressing the trigger, the output may vary depending on which MDF rules/groups match.

The problem is demonstrated in [Figure 16-1](#) and as follows:

1. As the label is moving through the field of view, it is first partially read (some of the barcodes in the field of view in Frame 2).
2. Then, the second decode occurs as it is fully read (all the barcodes in the field of view in Frame 3).
3. This yields two different outputs (instead of the expected single output) from the presentation of a label. This problem is driven by a complex label inadvertently matching two different MDF rules/groups, thereby yielding two outputs.

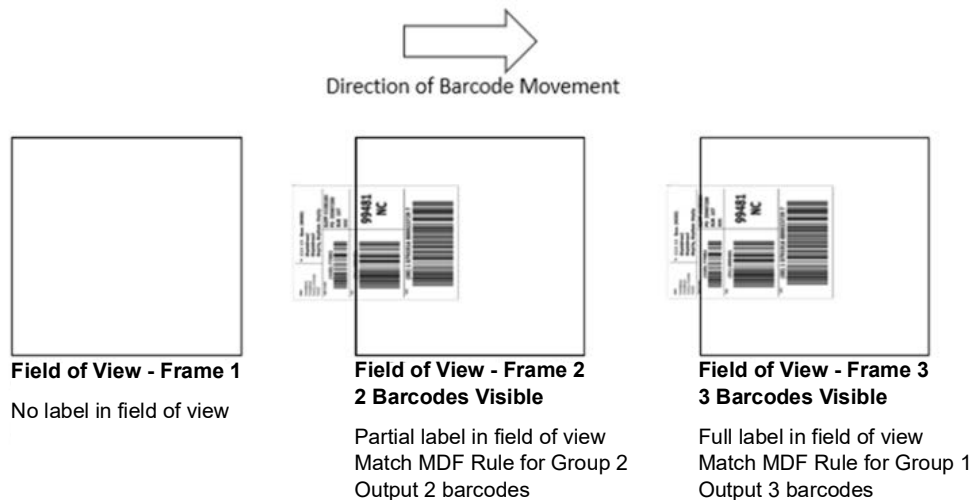

Figure 16-1 Scanning Label in a Horizontal Orientation

- ✓ **NOTE** To minimize issues associated with MDF hands-free mode, see [MDF Best Practices on page 16-3](#).

MDF Best Practices

Suggestions to minimize the undesired multiple outputs during the MDF scanning in hands-free mode are as follows:

- Scan barcodes in a vertical orientation (see [Figure 16-2](#)).

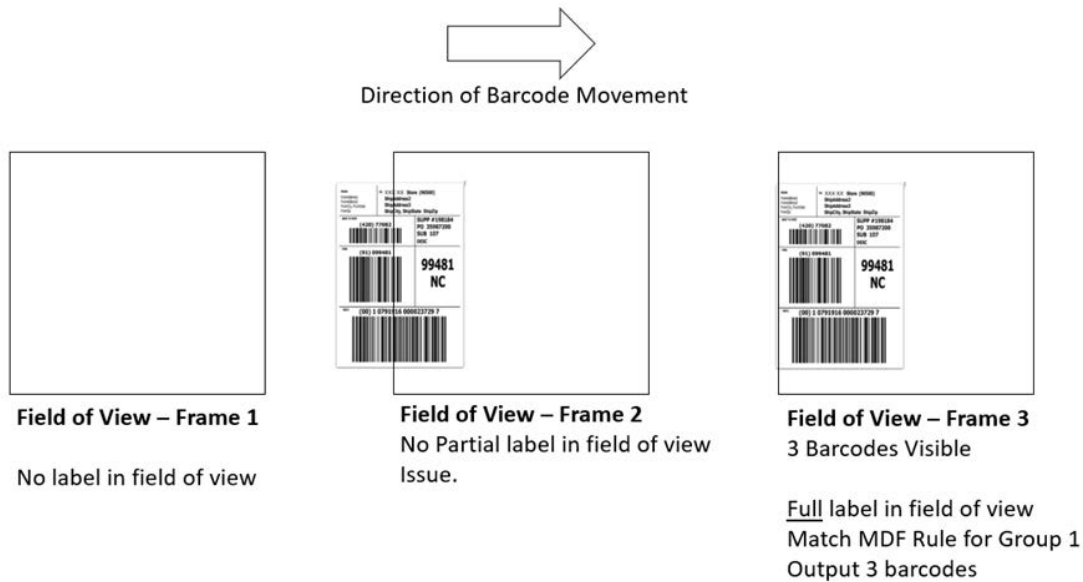

Figure 16-2 Scanning Label in a Vertical Orientation

- When creating the MDF programming with multiple groups, the Group 1's pattern match should be the most complicated (hardest to match), which equals to the most number of barcodes and criteria. Then Group 2, 3, and so on should be progressively matched more easily.
- When defining criteria, avoid enabling an output when the pattern is not matched. Set **Output if NO pattern match set** as **Discard bar code** (see [Figure 16-3](#)).

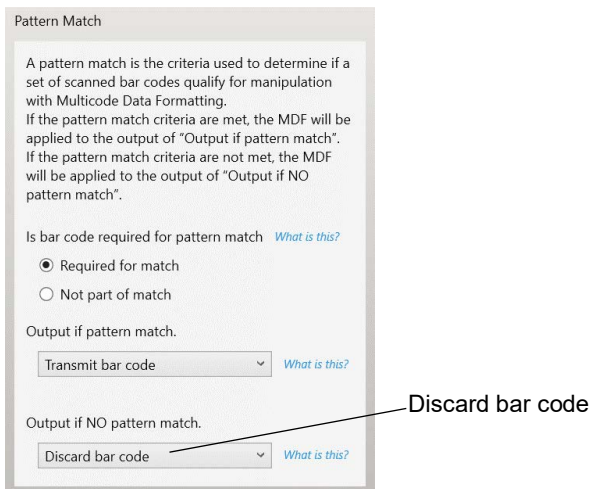

Figure 16-3 Figure Match Setting for Output

- Select **Discard barcode(s) NOT within the pattern match** in the 123Scan MDF setting. For more details, select **What is this?** located next to this selection.

Discard scanned bar code(s) NOT within pattern match [What is this?](#)

- To prevent double decodes of the same symbol, increase the **Timeout Between Same Symbols** setting. See [Timeout Between Decodes, Same Symbol on page 6-31](#) for more details.
- Turn the scanner's aimer on to assist operators in scanning the barcode in a more consistent manner.

Other reasons a label/barcode may not be decoded while in the field of view are as follows:

- The label out of focus (too close or too far away). See [DS36X8 Decode Ranges on page 3-14](#) for correct working range.
- Specular reflection (reflection off a shiny surface).
- The label is presented at extreme angle to scanner.

Preferred Symbol

Preferred Symbol is a barcode prioritization technique that enables favored decoding of high priority barcode(s). The Preferred Symbol is the only barcode that is decoded and output within the preset Preferred Symbol Timeout. During this time, the scanner attempts to decode the prioritized barcode and reports only this barcode.

For more information, refer to the *MDF and Preferred Symbol User Guide*.

To program Preferred Symbol via 123Scan, select **123Scan > Configuration Wizard > Symbologies** screen, and then select **Preferred Symbol** from the drop-down menu. Preferred Symbol programming is saved in the 123Scan configuration file.

CHAPTER 17 OCR PROGRAMMING

Introduction

This chapter describes how to set up the digital scanner for OCR programming. The digital scanner can read 6 to 60 point OCR typeface. It supports font types OCR-A, OCR-B, MICR-E13B, and US Currency Serial Number.

OCR is not as secure as a barcode. To decrease OCR misdecodes and speed OCR reading, set an accurate OCR template and character subset, and use a check digit.

All OCR fonts are disabled by default. Enabling OCR can slow barcode decoding. Enabling more than one OCR font could also slow OCR decoding and impact OCR decoding accuracy.

Throughout the programming barcode menus, asterisks (*) indicate default values. OCR Parameter Defaults



* Indicates Default — * **Disable OCR-A** — Feature/Option

✓ **NOTE** OCR pertains to the DS36X8-HP configuration only.

✓ **NOTE** Most computer monitors allow scanning the barcodes directly on the screen. When scanning from the screen, be sure to set the document magnification to a level where you can see the barcode clearly, and bars and/or spaces are not merging.

Table 17-1 lists the defaults for OCR parameters. To change any option, scan the appropriate barcode(s) provided in the Parameter Descriptions section beginning on [page 17-3](#).

✓ **NOTE** See [Appendix A, Standard Default Parameters](#) for all user preferences, hosts, symbologies, and default parameters.

Table 17-1 OCR Programming Default Table

Parameter	Parameter Number	SSI Number	Default	Page Number
OCR Programming Parameters				
OCR-A	680	F1h A8h	Disable	17-3
OCR-A Variant	684	F1h ACh	Full ASCII	17-4
OCR-B	681	F1h A9h	Disable	17-6
OCR-B Variant	685	F1h ADh	Full ASCII	17-7
MICR E13B	682	F1h AAh	Disable	17-11
US Currency	683	F1h ABh	Disable	17-12
OCR Orientation	687	F1h AFh	0°	17-12
OCR Lines	691	F1h B3h	1	17-14
OCR Minimum Characters	689	F1h B1h	3	17-14
OCR Maximum Characters	690	F1h B2h	100	17-15
OCR Subset	686	F1h AEh	Selected font variant	17-15
OCR Quiet Zone	695	F1h B7h	50	17-16
OCR Template	547	F1h 23h	99999999	17-17
OCR Check Digit Modulus	688	F1h B0h	1	17-27
OCR Check Digit Multiplier	700	F1h BCh	121212121212	17-28
OCR Check Digit Validation	694	F1h B6h	None	17-29
Inverse OCR	856	F2h 58h	Regular	17-34
OCR Redundancy	1770	F8h 06h EAh	Level 1	17-35

OCR Programming Parameters

Enable/Disable OCR-A

Parameter # 680 (SSI # F1h A8h)

To enable or disable OCR-A, scan one of the following barcodes.

- ✓ **NOTE** OCR is not as secure as a barcode. To decrease OCR misdecodes and speed OCR reading, set an accurate OCR template and character subset, and use a check digit. See [OCR Subset on page 17-15](#) and [OCR Template on page 17-17](#).
- ✓ **NOTE** All OCR fonts are disabled by default. Enabling OCR can slow barcode decoding. Enabling more than one OCR font could also slow OCR decoding and impact OCR decoding accuracy.



Enable OCR-A
(1)



* Disable OCR-A
(0)

OCR-A Variant

Parameter # 684 (SSI # F1 ACh)

Font variant sets a processing algorithm and default character subset for the given font. To choose a variant, scan one of the following barcodes. Selecting the most appropriate font variant optimizes performance and accuracy.

OCR-A supports the following variants:

- OCR-A Full ASCII
!"#\$()*+,-./0123456789<>ABCDEFGHIJKLMNOPQRSTUVWXYZ^
- OCR-A Reserved 1
\$*+,-./0123456789ABCDEFGHIJKLMNOPQRSTUVWXYZ
- OCR-A Reserved 2
\$*+,-./0123456789<>ABCDEFGHIJKLMNOPQRSTUVWXYZ
- OCR-A Banking
-0123456789<> ƒ ɹ ʞ

Special banking characters output as the following representative characters:

ƒ outputs as f

ɹ outputs as c

ʞ outputs as h

✓ **NOTE** Enable OCR-A before setting this parameter. If disabling OCR-A, set the variant to its default (OCR-A Full ASCII).

OCR-A Variant (continued)



*** OCR-A Full ASCII
(0)**



**OCR-A Reserved 1
(1)**



**OCR-A Reserved 2
(2)**

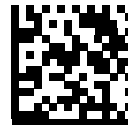

**OCR-A Banking
(3)**

Enable/Disable OCR-B

Parameter # 681 (SSI # F1h A9h)

To enable or disable OCR-B, scan one of the following barcodes.

- ✓ **NOTE** OCR is not as secure as a barcode. To decrease OCR misdecodes and speed OCR reading, set an accurate OCR template and character subset, and use a check digit. See [OCR Subset on page 17-15](#) and [OCR Template on page 17-17](#).
- ✓ **NOTE** All OCR fonts are disabled by default. Enabling OCR can slow barcode decoding. Enabling more than one OCR font could also slow OCR decoding and impact OCR decoding accuracy.

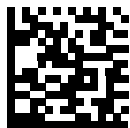

Enable OCR-B
(1)



* Disable OCR-B
(0)

OCR-B Variant

Parameter # 685 (SSI # F1h ADh)

OCR-B has the following variants. Selecting the most appropriate font variant affects performance and accuracy.

- OCR-B Full ASCII
!#\$%()*+,-./0123456789<>ABCDEFGHIJKLMNOPQRSTUVWXYZ^|ñ
- OCR-B Banking
#+-0123456789<>JNP|
- OCR-B Limited
+,-./0123456789<>ACENPSTVX
- OCR-B ISBN 10-Digit Book Numbers
-0123456789>BCEINPSXz
- OCR-B ISBN 10 or 13-Digit Book Numbers
-0123456789>BCEINPSXz
- OCR-B Travel Document Version 1 (TD1) 3-Line ID Cards
-0123456789<ABCDEFGHIJKLMNOPQRSTUVWXYZ
- OCR-B Travel Document Version 2 (TD2) 2-Line ID Cards
-0123456789<ABCDEFGHIJKLMNOPQRSTUVWXYZ
- OCR-B Travel Document 2 or 3-Line ID Cards Auto-Detect
!#\$%()*+,-./0123456789<>ABCDEFGHIJKLMNOPQRSTUVWXYZ^|ñ
- OCR-B Passport
-0123456789<ABCDEFGHIJKLMNOPQRSTUVWXYZñ
- OCR-B Visa Type A
-0123456789<ABCDEFGHIJKLMNOPQRSTUVWXYZ
- OCR-B Visa Type B
-0123456789<ABCDEFGHIJKLMNOPQRSTUVWXYZñ
- OCR-B ICAO Travel Documents
This allows reading either TD1, TD2, Passport, Visa Type A, or Visa Type B without switching between these options. It automatically recognizes the travel document read.

To choose a variant, scan one of the following barcodes. Selecting the following OCR-B variants automatically sets the appropriate [OCR Lines on page 17-14](#). These five variants invoke extensive special algorithms and checking for that particular document type:

Variant	OCR Lines Setting
Passport	2
TD1 ID Cards	3
TD2 ID Cards	2
Visa Type A	2
Visa Type B	2

Selecting one of the ISBN Book Numbers automatically applies the appropriate ISBN checksum, so you do not need to set this.

OCR-B Variant (continued)

For the best performance in passport reading, fix the target passport and the decoder in place (6.5 - 7.5").

- ✓ **NOTE** Enable OCR-B before setting this parameter. If disabling OCR-B, set the variant to its default (OCR-B Full ASCII).



* OCR-B Full ASCII
(0)



OCR-B Banking
(1)



OCR-B Limited
(2)



OCR-B ISBN 10-Digit Book Numbers
(6)

OCR-B Variant (continued)



**OCR-B ISBN 10 or 13-Digit Book Numbers
(7)**



**OCR-B Travel Document Version 1 (TD1)
3 Line ID Cards
(3)**



**OCR-B Travel Document Version 2 (TD2)
2-Line ID Cards
(8)**



**Travel Document 2 or 3-Line ID Cards Auto-Detect
(20)**

OCR-B Variant (continued)



**OCR-B Passport
(4)**



**OCR-B Visa Type A
(9)**

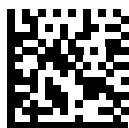

**OCR-B Visa Type B
(10)**

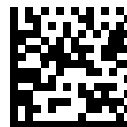

**OCR-B ICAO Travel Documents
(11)**

Enable/Disable MICR E13B

Parameter # 682 (SSI # F1h AAh)

To enable or disable MICR E13B, scan one of the following barcodes.

MICR E13B uses the following characters:

0 1 2 3 4 5 6 7 8 9 t a o d

TOAD characters (Transit, On Us, Amount, and Dash) output as the following representative characters:

t outputs as t

a outputs as a

o outputs as o

d outputs as d

- ✓ **NOTE** OCR is not as secure as a barcode. To decrease OCR misdecodes and speed OCR reading, set an accurate OCR template and character subset, and use a check digit. See [OCR Subset on page 17-15](#) and [OCR Template on page 17-17](#).
- ✓ **NOTE** All OCR fonts are disabled by default. Enabling OCR can slow barcode decoding. Enabling more than one OCR font could also slow OCR decoding and impact OCR decoding accuracy.



Enable MICR E13B
(1)



* Disable MICR E13B
(0)

Enable/Disable US Currency Serial Number

Parameter # 683 (SSI # F1h ABh)

To enable or disable US Currency Serial Number, scan one of the following barcodes.

- ✓ **NOTE** OCR is not as secure as a barcode. To decrease OCR misdecodes and speed OCR reading, set an accurate OCR template and character subset, and use a check digit. See [OCR Subset on page 17-15](#) and [OCR Template on page 17-17](#).
- ✓ **NOTE** All OCR fonts are disabled by default. Enabling OCR can slow barcode decoding. Enabling more than one OCR font could also slow OCR decoding and impact OCR decoding accuracy.



**Enable US Currency
(1)**



*** Disable US Currency
(0)**

OCR Orientation

Parameter # 687 (SSI # F1h AFh)

Select one of five options to specify the orientation of an OCR string to be read:

- 0° to the imaging engine (default)
- 270° clockwise (or 90° counterclockwise) to the imaging engine
- 180° (upside down) to the imaging engine
- 90° clockwise to the imaging engine
- Omnidirectional

Setting an incorrect orientation can cause misdecodes.

OCR Orientation (continued)



*** OCR Orientation 0°
(0)**

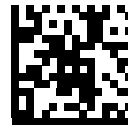

**OCR Orientation 270° Clockwise
(1)**



**OCR Orientation 180° Clockwise
(2)**



**OCR Orientation 90° Clockwise
(3)**



**OCR Orientation Omnidirectional
(4)**

OCR Lines

Parameter # 691 (SSI # F1h B3h)

To select the number of OCR lines to decode, scan one of the following barcodes. Selecting Visas, TD1, or TD2 ID cards automatically sets the appropriate **OCR Lines**. Also see [OCR-B Variant on page 17-7](#).

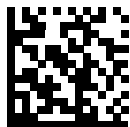

* OCR 1 Line
(1)



OCR 2 Lines
(2)



OCR 3 Lines
(3)

OCR Minimum Characters

Parameter # 689 (SSI # F1h B1h)

To select the minimum number of OCR characters (not including spaces) per line to decode, scan the following barcode, then scan a three-digit number between 003 and 100 using the barcodes in [Appendix H, Numeric Bar Codes](#) representing the number of OCR characters to decode. Strings of OCR characters less than the minimum are ignored. The default is 003.



OCR Minimum Characters

OCR Maximum Characters

Parameter # 690 (SSI # F1h B2h)

To select the maximum number of OCR characters (including spaces) per line to decode, scan the following barcode, then scan a three-digit number between 003 and 100 using the barcodes in [Appendix H, Numeric Bar Codes](#) representing the number of OCR characters to decode. Strings of OCR characters greater than the maximum are ignored. The default is 100.



OCR Maximum Characters

OCR Subset

Parameter # 686 (SSI # F1h AEh)

Set an OCR subset to define a custom group of characters in place of a preset font variant. For example, if scanning only numbers and the letters A, B, and C, create a subset of just these characters to speed decoding. This applies a designated OCR Subset across all enabled OCR fonts.

To set or modify the OCR font subset, first enable the appropriate OCR font(s). Next, scan the following barcode, then scan numbers and letters to form the OCR Subset from the alphanumeric keyboard in the *Advanced Data Formatting Guide*. Then scan **End of Message** in the *Advanced Data Formatting Guide*.



OCR Subset

To cancel an OCR subset, for OCR-A or OCR-B, set OCR-A variant **Full ASCII**, or OCR-B variant **Full ASCII**, and set subset to NULL string.

For MICR E13B or US Currency Serial Number, create a subset which includes all allowed characters in that character set, or scan an option from the [Default Parameters on page 6-5](#) and re-program the digital scanner.

OCR Quiet Zone

Parameter # 695 (SSI # F1h B7h)

This option sets the OCR quiet zone. The digital scanner stops scanning a field when it detects a sufficiently wide blank space. The width of this space is defined by the End of Field option. Used with parsers that tolerate slanted characters, the End of Field count is roughly a count of 8 for a character width. For example if set to 15, then two character widths are an end of line indicator for the parser. Larger end of field numbers require bigger quiet zones at each end of text line.

To set a quiet zone, scan the following barcode, then scan a two-digit number using the numeric keypad in the *Advanced Data Formatting Guide*. The range of the quiet zone is 20 - 99 and the default is 50, indicating a six character width quiet zone.



OCR Quiet Zone

OCR Template

Parameter # 547 (SSI # F1h 23h)

This option creates a template for precisely matching scanned OCR characters to a desired input format. Carefully constructing an OCR template eliminates scanning errors.

To set or modify the OCR decode template, scan the [OCR Template](#) barcode, then barcodes corresponding to numbers and letters on the following pages to form the template expression. Then scan **End of Message** in the *Advanced Data Formatting Guide*. The default is **99999999** which accepts OCR strings only containing eight digits.



OCR Template



End of Message

Required Digit (9)



9

Only a numeric character is allowed in this position.

Template	Valid data	Valid data	Invalid data
99999	12987	30517	123AB

Required Alpha (A)

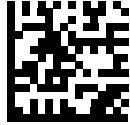

A

Only an alpha character is allowed in this position.

Template	Valid data	Valid data	Invalid data
AAA	ABC	WXY	12F

Optional Alphanumeric (1)



1

When this option appears in the template string, the data validator accepts an alphanumeric character if present. Optional characters are not allowed as the first character(s) in a field of like characters.

Template	Valid data	Valid data	Invalid data
99991	1234A	12345	1234<

Optional Alpha (2)



2

When this option appears in the template string, the data validator accepts an alpha character if present. Optional characters are not allowed as the first character(s) in a field of like characters.

Template	Valid data	Valid data	Invalid data
AAAA2	ABCDE	WXYZ	ABCD6

Alpha or Digit (3)**3**

The data validator requires an alphanumeric character in this position to validate the incoming data.

Template	Valid data	Valid data	Invalid data
33333	12ABC	WXY34	12AB<

Any Including Space & Reject (4)**4**

The template accepts any character in this position, including space and reject. Rejects are represented as an underscore (_) in the output. This is a good selection for troubleshooting.

Template	Valid data	Valid data
99499	12\$34	34_98

Any except Space & Reject (5)



5

The template accepts any character in this position except a space or reject.

Template	Valid data	Valid data	Invalid data
55999	A.123	*Z456	A BCD

Optional Digit (7)



7

When this option appears in the template string, the template accepts a numeric character if present. Optional characters are not allowed as the first character(s) in a field of like characters.

Template	Valid data	Valid data	Invalid data
99977	12345	789	789AB

Digit or Fill (8)

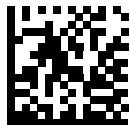

8

The data validator accepts any numeric or fill character in this position.

Template	Valid data	Valid data	Valid data
88899	12345	>>789	<<789

Alpha or Fill (F)

F

The data validator accepts any alpha or fill character in this position.

Template	Valid data	Valid data	Valid data
AAAFF	ABCXY	LMN>>	ABC<5

Optional Space ()

Space

When this option appears in the template string, the template accepts a space if present. Optional characters are not allowed as the first character(s) in a field of like characters.

Template	Valid data	Valid data	Invalid data
99 99	12 34	1234	67891

Optional Small Special (.)

.

When this option appears in the template string, the data validator accepts a special character if present. Optional characters are not allowed as the first character(s) in a field of like characters. Small special characters are -, , and .

Template	Valid data	Valid data	Invalid data
AA.99	MN.35	XY98	XYZ12

Other Template Operators

These template operators assist in capturing, delimiting, and formatting scanned OCR data.

Literal String (" and +)



“



+

Use either of these delimiting characters surrounding characters from the alphanumeric keyboard in the *Advanced Data Formatting Guide* to define a literal string within a template that must be present in scanned OCR data. There are two characters used to delimit required literal strings; if one of the delimiter characters is present in the desired literal string, use the other delimiter.

Template	Valid data	Invalid data
"35+BC"	35+BC	AB+22

New Line (E)



E

To create a template of multiple lines, add **E** between the template of each single line.

Template	Valid data	Valid data	Invalid data
999EAAAA	321	987	XYZW
	BCAD	ZXYW	12

String Extract (C)**C**

This operator combined with others defines a string of characters to extract from the scanned data. The string extract is structured as follows:

`CbPe`

Where:

- `C` is the string extract operator
- `b` is the string begin delimiter
- `P` is the category (one or more numeric or alpha characters) describing the string representation
- `e` is the string end delimiter

Values for `b` and `e` can be any scannable character. They are included in the output stream.

Template	Incoming data	Output
<code>C>A></code>	<code>XQ3>ABCDE></code>	<code>>ABCDE></code>
	<code>->ATHRUZ>123</code>	<code>>ATHRUZ></code>
	<code>1ABCZXYZ</code>	No Output

Ignore to End of Field (D)**D**

This operator causes all characters after a template to be ignored. Use this as the last character in a template expression. Examples for the template `999D`:

Template	Incoming data	Output
<code>999D</code>	<code>123-PED</code>	<code>123</code>
	<code>357298</code>	<code>357</code>
	<code>193</code>	<code>193</code>

Skip Until (P1)



P



1

This operator allows skipping over characters until a specific character type or a literal string is detected. It can be used in two ways:

P1ct

Where:

- P1 is the Skip Until operator
- c is the type of character that triggers the start of output
- t is one or more template characters

P1"s"t

Where:

- P1 is the Skip Until operator
- "s" is one or more literal string characters (see [Literal String \(" and +\) on page 17-22](#)) that trigger the start of output
- t is one or more template characters

The trigger character or literal string is included in output from a Skip Until operator, and the first character in the template should accommodate this trigger.

Template	Incoming data	Output
P1"PN"AA9999	123PN9876	PN9876
	PN1234	PN1234
	X-PN3592	PN3592

Skip Until Not (P0)

P



0

This operator allows skipping over characters until a specific character type or a literal string is not matched in the output stream. It can be used in two ways:

```
P0ct
```

Where:

- P0 is the Skip Until Not operator
- c is the type of character that triggers the start of output
- t is one or more template characters

```
P0"s"t
```

Where:

- P0 is the Skip Until Not operator
- "s" is one or more literal string characters (see [Literal String \(" and +\) on page 17-22](#)) that trigger the start of output
- t is one or more template characters

The trigger character or literal string is not included in output from a Skip Until Not operator.

Template	Incoming data	Output
P0A9999	BPN3456	3456
	PN1234	1234
	5341	No output

Template	Incoming data	Output
P0"PN"9999	PN3456	3456
	5341	No output
	PNPN7654	7654

Repeat Previous (R)



R

This operator allows a template character to repeat one or more times, allowing the capture of variable-length scanned data. The following examples capture two required alpha characters followed by one or more required digits:

Template	Incoming data	Output
AA9R	AB3	AB3
	PN12345	PN12345
	32RM52700	No output

Scroll Until Match (S)



S

This operator steps through scanned data one character at a time until the data matches the template.

Template	Incoming data	Output
S99999	AB3	No Output
	PN12345	12345
	32RM52700	52700

Multiple Templates

This feature sets up multiple templates for OCR decoding. To do this, follow the procedure described in [OCR Template on page 17-17](#) (scan the [OCR Template](#) barcode, then barcodes corresponding to numbers and letters to form the template expression, then **End of Message**) for each template in the multiple template string, using a capital letter **X** as a separator between the templates.

For example, set the [OCR Template](#) as **99999XAAAAA** to decode OCR strings of either **12345** or **ABCDE**.

Template Examples

Following are sample templates with descriptions of valid data for each definition.

Field Definition	Description
"M"99977	M followed by three digits and two optional digits.
"X"997777"X"	X followed by two digits, four optional digits, and an X .
9959775599	Two digits followed by any character, a digit, two optional digits, any two characters, and two digits.
A55"--"999"--"99	A letter followed by two characters, a dash, three digits, a dash, and two digits.
33A". "99	Two alphanumeric characters followed by a letter, a period, and two digits.
999992991	Five digits followed by an optional alpha, two digits, and an optional alphanumeric.
"PN98"	Literal field - PN98

OCR Check Digit Modulus

Parameter # 688 (SSI # F1h B0h)

This option sets OCR module check digit calculation. The check digit is the last digit (in the right most position) in an OCR string and improves the accuracy of the collected data. The check digit is the end product of a calculation made on the incoming data. For check digit calculation, for example Modulus 10, alpha and numeric characters are assigned numeric weights (see [OCR Check Digit Multiplier on page 17-28](#)). The calculation is applied to the character weights and the resulting check digit is added to the end of the data. If the incoming data does not match the check digit, the data is considered corrupt.

The selected check digit option does not take effect until you set **OCR Check Digit Validation**.

To choose the Check Digit Modulus, such as 10 for modulo 10, scan the following barcode, then scan a three-digit number from 001 to 099 representing the check digit using the numeric keypad in the *Advanced Data Formatting Guide*. The default is 1.



OCR Check Digit

OCR Check Digit Multiplier

Parameter # 700 (SSI # F1h BCh)

This option sets OCR check digit multipliers for the character positions. For check digit validation, each character in scanned data has an equivalent weight used in the check digit calculation. DS36X8 OCR ships with the following weight equivalents:

0 = 0	A = 10	K = 20	U = 30
1 = 1	B = 11	L = 21	V = 31
2 = 2	C = 12	M = 22	W = 32
3 = 3	D = 13	N = 23	X = 33
4 = 4	E = 14	O = 24	Y = 34
5 = 5	F = 15	P = 25	Z = 35
6 = 6	G = 16	Q = 26	Space = 0
7 = 7	H = 17	R = 27	
8 = 8	I = 18	S = 28	
9 = 9	J = 19	T = 29	

All other characters are equivalent to one (1).

You can define the multiplier string if it is different from the default.

121212121212 (default)

123456789A (for ISBN, Product Add Right to Left. See [OCR Check Digit Validation on page 17-29](#).)

For example:

ISBN	0	2	0	1	1	8	3	9	9	4	
Multiplier	10	9	8	7	6	5	4	3	2	1	
Product	0	18	0	7	6	40	12	27	18	4	
Product add	0+	18+	0+	7+	6+	40+	12+	27+	18+	4=	132

ISBN uses modulo 11 for its check digit. In this case, 132 is divisible by 11, so it passes the check digit.

To set the check digit multiplier, scan the following barcode, then scan numbers and letters to form the multiplier string from the alphanumeric keyboard in the *Advanced Data Formatting Guide*. Then scan **End of Message** in the *Advanced Data Formatting Guide*.



OCR Check Digit Multiplier

OCR Check Digit Validation

Parameter # 694 (SSI # F1h B6h)

Use **OCR Check Digit Validation** to protect against scanning errors by applying a check digit validation scheme. The following is a list of options.

None

No check digit validation, indicating no check digit is applied. This is the default.



*** No Check Digit
(0)**

Product Add Left to Right

Each character in the scanned data is assigned a numeric value (see [OCR Check Digit Multiplier on page 17-28](#)). Each digit representing a character in the scanned data is multiplied by its corresponding digit in the multiplier, and the sum of these products is computed. The check digit passes if this sum modulo Check Digit Modulus is zero.

Example:

Scanned data numeric value is 132456 (check digit is 6)

Check digit multiplier string is 123456

Digit	1	3	2	4	5	6
Multiplier	1	2	3	4	5	6
Product	1	6	6	16	25	36
Product add	1+	6+	6+	16+	25+	36= 90

The Check Digit Modulus is 10. It passes because 90 is divisible by 10 (the remainder is zero).



**Product Add Left to Right
(3)**

Product Add Right to Left

Each character in the scanned data is assigned a numeric value (see [OCR Check Digit Multiplier on page 17-28](#)). The check digit multiplier is reversed in order. Each value representing a character in the scanned data is multiplied by its corresponding digit in the reversed multiplier, resulting in a product for each character in the scanned data. The sum of these products is computed. The check digit passes if this sum modulo Check Digit Modulus is zero.

Example:

Scanned data numeric value is 132459 (check digit is 9)

Check digit multiplier string is 123456

Digit	1	3	2	4	5	9
Multiplier	6	5	4	3	2	1
Product	6	15	8	12	10	9
Product add	6+	15+	8+	12+	10+	9= 60

The Check Digit Modulus is 10. It passes because 60 is divisible by 10 (the remainder is 0).



**Product Add Right to Left
(1)**

Digit Add Left to Right

Each character in the scanned data is assigned a numeric value (see [OCR Check Digit Multiplier on page 17-28](#)). Each value representing a character in the scanned data is multiplied by its corresponding digit in the multiplier, resulting in a product for each character in the scanned data. The sum of each individual digit in all of the products is then calculated. The check digit passes if this sum modulo Check Digit Modulus is zero.

Example:

Scanned data numeric value is 132456 (check digit is 6)

Check digit multiplier string is 123456

Digit	1	3	2	4	5	6
Multiplier	1	2	3	4	5	6
Product	1	6	6	16	25	36
Digit add	1+	6+	6+	1+6+	2+5+	3+6= 36

The Check Digit Modulus is 12. It passes because 36 is divisible by 12 (the remainder is 0).



**Digit Add Left to Right
(4)**

Digit Add Right to Left

Each character in the scanned data is assigned a numeric value (see [OCR Check Digit Multiplier on page 17-28](#)). The check digit multiplier is reversed in order. Each value representing a character in the scanned data is multiplied by its corresponding digit in the reversed multiplier, resulting in a product for each character in the scanned data. The sum of each individual digit in all of the products is then calculated. The check digit passes if this sum modulo Check Digit Modulus is zero.

Example:

Scanned data numeric value is 132456 (check digit is 6)

Check digit multiplier string is 123456

Digit	1	3	2	4	5	6	
Multiplier	6	5	4	3	2	1	
Product	6	15	8	12	10	6	
Digit add	6+	1+5+	8+	1+2+	1+0+	6=	30

The Check Digit Modulus is 10. It passes because 30 is divisible by 10 (the remainder is 0).

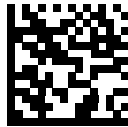

Digit Add Right to Left
(2)

Product Add Right to Left Simple Remainder

Each character in the scanned data is assigned a numeric value (see [OCR Check Digit Multiplier on page 17-28](#)). The check digit multiplier is reversed in order. Each value representing a character in the scanned data is multiplied by its corresponding digit in the reversed multiplier, resulting in a product for each character in the scanned data. The sum of these products **except for the check digit's product** is computed. The check digit passes if this sum modulo Check Digit Modulus is equal to the check digit's product.

Example:

Scanned data numeric value is 122456 (check digit is 6)

Check digit multiplier string is 123456

Digit	1	2	2	4	5	6	
Multiplier	6	5	4	3	2	1	
Product	6	10	8	12	10	6	
Product add	6+	10+	8+	12+	10=	46	6

The Check Digit Modulus is 10. It passes because 46 divided by 10 leaves a remainder of 6.



Product Add Right to Left Simple Remainder
(5)

Digit Add Right To Left Simple Remainder

Each character in the scanned data is assigned a numeric value (see [OCR Check Digit Multiplier on page 17-28](#)). The check digit multiplier is reversed in order. Each value representing a character in the scanned data is multiplied by its corresponding digit in the reversed multiplier, resulting in a product for each character in the scanned data. The sum of each individual digit in all of the products **except for the check digit's product** is then calculated. The check digit passes if this sum modulo Check Digit Modulus is equal to the check digit's product.

Example:

Scanned data numeric value is 122459 (check digit is 6)

Check digit multiplier string is 123456

Digit	1	2	2	4	5	9
Multiplier	6	5	4	3	2	1
Product	6	10	8	12	10	9
Digit add	6+	1+0+	8+	1+2+	1+0=	19 9

The Check Digit Modulus is 10. It passes because 19 divided by 10 leaves a remainder of 9.

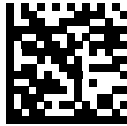

Digit Add Right to Left Simple Remainder
(6)

Health Industry - HIBCC43

This is the health industry module 43 check digit standard. The check digit is the modulus 43 sum of all the character values in a given message, and is printed as the last character in a given message.

Example:

Supplier Labeling Data Structure: + A 1 2 3 B J C 5 D 6 E 7 1

Sum of values: $41+10+1+2+3+11+19+12+5+13+6+14+7+1 = 145$

Divide 145 by 43. The quotient is 3 with a remainder of 16. The check digit is the character corresponding to the value of the remainder (see [Table 17-2](#)), which in this example is 16, or **G**. The complete Supplier Labeling Data Structure, including the check digit, therefore is:

A 1 2 3 B J C 5 D 6 E 7 1 G

Table 17-2 *Table of Numeric Value Assignments for Computing HIBC LIC Data Format Check Digit*

0 = 0	9 = 9	I = 18	R = 27	- = 36
1 = 1	A = 10	J = 19	S = 28	. = 37
2 = 2	B = 11	K = 20	T = 29	Space = 38
3 = 3	C = 12	L = 21	U = 30	\$ = 39
4 = 4	D = 13	M = 22	V = 31	/ = 40
5 = 5	E = 14	N = 23	W = 32	+ = 41
6 = 6	F = 15	O = 24	X = 33	% = 42
7 = 7	G = 16	P = 25	Y = 34	
8 = 8	H = 17	Q = 26	Z = 35	



Inverse OCR

Parameter # 856 (SSI # F2h 58h)

Inverse OCR is white or light words on a black or dark background. Select an option for decoding inverse OCR:

- **Regular Only** - decode regular OCR (black on white) strings only.
- **Inverse Only** - decode inverse OCR (white on black) strings only.
- **Autodiscriminate** - decodes both regular and inverse OCR strings.



* Regular Only
(0)



Inverse Only
(1)



Autodiscriminate
(2)

OCR Redundancy

Parameter # 1770 (SSI # F8h 06h EAh)

This option adjusts the number of times to decode an OCR text string before transmission. There are three levels of OCR decode redundancy. There is an inverse relationship between the redundancy level and OCR decoding aggressiveness. Increasing the level of the redundancy can reduce OCR scanning aggressiveness, so select only the level of redundancy necessary.

- **OCR Redundancy Level 1:** This default setting allows the scanner to operate in its most aggressive state while providing sufficient accuracy in decoding most in-spec OCR text strings.
- **OCR Redundancy Level 2:** This setting eliminates most misdecodes while maintaining reasonable aggressiveness.
- **OCR Redundancy Level 3:** Select this option with greater redundancy requirements if OCR Redundancy Level 2 fails to eliminate misdecodes.

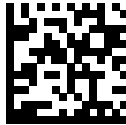

* OCR Redundancy Level 1
(1)



OCR Redundancy Level 2
(2)



OCR Redundancy Level 3
(3)

APPENDIX A STANDARD DEFAULT PARAMETERS

Table A-1 *Parameter Defaults*

Parameter	Parameter Number	SSI Number	Default	Page Number
Radio Communications				
Radio Communications Host Types	383	F0h 7Fh	Cradle Host	5-5
BT Friendly Name	607	F1h 5Fh	n/a	5-11
Discoverable Mode	610	F1h 62h	General	5-12
Wi-Fi Friendly Mode	1299	F8h 05h 13h	Disable	5-13
Wi-Fi Friendly Channel Exclusion	1297	F8h 05h 11h	Use All Channels	5-14
Radio Output Power	1324	F8h 05h 12Ch	High	5-17
Link Supervision Timeout	1698	F8h 06h A2h	5 Seconds	5-18
Bluetooth Radio State	1354	F8h 05h 4Ah	On	5-19
Apple iOS Virtual Keyboard Toggle	1114	F8h 04h 5Ah	Disable	5-20
HID Keyboard Keystroke Delay	N/A	N/A	No Delay (0 msec)	5-21
CAPS Lock Override	N/A	N/A	Disable	5-21
HID Ignore Unknown Characters	N/A	N/A	Send Bar Codes with Unknown Characters	5-22
Emulate Keypad	N/A	N/A	Enable	5-22
Fast HID Keyboard	1361	F8h 05h 51h	Enable	5-23
Quick Keypad Emulation	1362	F8h 05h 52h	Enable	5-23

Table A-1 *Parameter Defaults (Continued)*

Parameter	Parameter Number	SSI Number	Default	Page Number
Keyboard FN1 Substitution	N/A	N/A	Disable	5-24
Function Key Mapping	N/A	N/A	Disable	5-24
Simulated Caps Lock	N/A	N/A	Disable	5-25
Convert Case	N/A	N/A	No Case Conversion	5-25
Reconnect Attempt Beep Feedback	559	F1h 2Fh	Disable	5-27
Reconnect Attempt Interval	558	F1h 2Eh	30 Seconds	5-28
Auto-reconnect	604	F1h 5Ch	Auto-reconnect Immediately	5-30
Sleep Between Attempts	1778	F8h 06h F2h	Sleep for 1 Minute	5-31
Number of Retry Attempts	1779	F8h 06h F3h	Do Not Retry	5-32
Beep on Insertion	288	120h	Enable	5-34
Modes of Operation (Point-to-Point/ Multipoint-to-Point)	538	F1h 1Ah	Point-to-Point	5-35
Parameter Broadcast (Cradle Host Only)	148	94h	Enable	5-36
Pairing Modes	542	F1h 1Eh	Unlocked	5-37
Pairing Methods	545	F1h 21h	Enable	5-38
Toggle Pairing	1322	F8h 05h 2Ah	Disable	5-39
Connection Maintenance Interval	5002	N/A	15 Minutes	5-40
AutoConfig (Scanner Cloning Through Cradle)	2139	F8 08 5B	Disable	5-43
Batch Mode	544	F1h 20h	Normal (Do Not Batch Data)	5-43
Persistent Batch Storage	1399	F8h 05h 77h	Disable	5-48
Page Button	746	F1h EAh	Enable	5-49
Page Options				
Page Mode	1364	F8h 05h 54h	Page Simple	5-50
Page State Timeout	1365	F8h 05h 55h		5-51
PIN Code (Set and Store)	552	F1h 28h	12345	5-52
Variable Pin Code	608	F1h 60h	Static (Default PIN code is 12345)	5-53
Bluetooth Security Levels	1393	F8h 05h 71h	Low	5-54

Table A-1 *Parameter Defaults (Continued)*

Parameter	Parameter Number	SSI Number	Default	Page Number
Save Bluetooth Connection Information	1743	F8h 06h CFh	Enable	5-56
Configuring the Alarm on the Scanner	2053	F8h 08h 05h	Disable	5-57
Audio Virtual Tether Alarm on Scanner	2246	F8h 08h C6h	Enable Audio Virtual Tether Alarm	5-58
LED Virtual Tether Alarm on Scanner	2247	F8h 08h C7h	Enable	5-58
Illumination Virtual Tether Alarm on Scanner	2248	F8h 08h C8h	Enable	5-59
Haptic Virtual Tether Alarm on Scanner	2249	F8h 08h C9h	Enable	5-59
Virtual Tether Alarm on the Cradle	2124	F8h 08h 4Ch	Disable	5-60
Delay Before Virtual Alarm Activates	2054	F8h 08h 06h	None	5-60
Virtual Tether Alarm Duration	2055	F8h 08h 07h	None	5-61
Defeat Virtual Tether Alarm	2119	F8h 08h 47h	Pause Alarm on Trigger Pull/Page Button	5-62
Pause Virtual Tether Alarm Duration	2120	F8h 08h 48h	None	5-63
User Preferences				
Set Default Parameter	N/A	N/A	Restore Defaults	6-5
Parameter Bar Code Scanning	236	ECh	Enable	6-6
Beep After Good Decode	56	38h	Enable	6-6
Beep on <BEL>	150	96h	Enable	6-7
Direct Decode Indicator	859	F2h 5Bh	Disable	6-8
Beeper Volume	140	8Ch	High	6-9
Beeper Tone	145	91h	Medium	6-10
Beeper Duration	628	F1h 74h	Medium	6-11
Suppress Power Up Beeps	721	F1h D1h	Do Not Suppress	6-12
Decode Pager Motor	613	F1h 65h	Enable	6-13
Decode Pager Motor Duration	626	F1h 72h	150 msec	6-13

Table A-1 *Parameter Defaults (Continued)*

Parameter	Parameter Number	SSI Number	Default	Page Number
Low Power Mode	128	80h	Enable (DS3678) Disable (DS3608)	6-15
Time Delay to Low Power Mode	146	92h	100 msec (DS3678) 1 Hour (DS3608)	6-16
Timeout to Low Power Mode from Auto Aim (DS3678 Only)	729	N/A	15 Seconds	6-19
DS3608-ER Power Mode	1777	F8 06 F1	Extended Range Full Power Mode	6-20
Battery Preservation Mode	1765	F8h 06h E5h	Enable	6-20
Hand-held Trigger Mode	138	8Ah	Level	6-22
Hands-free Mode	630	F1h 76h	Enable	6-23
Hand-held Decode Aiming Pattern	306	F0h 32h	Enable	6-24
Hands-free (Presentation) Decode Aiming Pattern	590	F1h 4Eh	Enable Hands-free (Presentation) Decode Aiming Pattern on PDF	6-25
Picklist Mode	402	F0h 92h	Disabled Always	6-26
Outdoor Picklist Mode	1880	N/A	Disable	6-27
FIPS Mode (DS3678 Only)	736	F1h E0h	Disable	6-28
Continuous Bar Code Read	649	F1h 89h	Disable	6-28
Unique Bar Code Reporting	723	F1h D3h	Enable	6-29
Decode Session Timeout	136	88h	9.9 Seconds	6-30
Hands-free Decode Session Timeout	400	F0h 90h	15	6-30
Timeout Between Decodes, Same Symbol	137	89h	0.5 Seconds	6-31
Timeout Between Decodes, Different Symbols	144	90h	0.1 Seconds	6-31
Triggered Timeout, Same Symbol	724	F1 D4	Disable	6-32
Mobile Phone/Display Mode	716	F1h CCh	Normal	6-33
PDF Prioritization	719	F1h CFh	Disable	6-34
PDF Prioritization Timeout	720	F1h D0h	200 msec	6-35

Table A-1 *Parameter Defaults (Continued)*

Parameter	Parameter Number	SSI Number	Default	Page Number
Presentation Mode Field of View	609	F1h 61h	Full	6-36
Decoding Illumination	298	F0h 2Ah	Enable	6-37
Motion Tolerance (Hand-held Trigger Mode Only)	858	F2h 5Ah	Less	6-37
Ranging Light Immunity (DS36X8-ER only)	1722	F8h 06h BAh	60Hz Immunity	6-38
Battery Threshold				6-39
Battery Status High Threshold	1367	N/A	50%	
Battery Status Medium Threshold	1368		20%	
Battery Status Low Warning Threshold	1369		10%	
Battery Health Low Warning Threshold	1370		60%	
Add an Enter Key	N/A	N/A	N/A	6-41
Transmit Code ID Character	45	2Dh	None	6-42
Prefix Value	99, 105	63h, 69h	7013 <CR><LF>	6-43
Suffix 1 Value	98, 104	62h, 68h	7013 <CR><LF>	6-43
Suffix 2 Value	100, 106	64h, 6Ah		
Scan Data Transmission Format	235	EBh	Data as is	6-44
FN1 Substitution Values	103, 109	67h, 6Dh	7013 <CR><LF>	6-45
Transmit "No Read" Message	94	5Eh	Disable	6-46
Unsolicited Heartbeat Interval	1118	F8h 04h 5Eh	Disable	6-47
Product ID (PID) Type	1281	F8h 05h 01h	Host Type Unique	6-48
Product ID (PID) Value	1725	F8h 06h BDh	0	6-49
UID	740	F1 E4	Disable	6-50
UID Error Mode Options	742	F1 E6	UID Error Beep	6-52
DPM Mode (DS36X8-DP only)	1438	F8 05 9E	DPM Mode 2	6-56
DPM Illumination Control (DS36X8-DP only)	429	F0 AD	Cycle Illumination	6-57
DPM Rough Shiny Surface Decoding (DS36X8-DP only)	1904	N/A	Disable	6-58
Ultra High Density DPM Decoding (DS36X8-DP only)	1903	N/A	Disable	6-59

Table A-1 *Parameter Defaults (Continued)*

Parameter	Parameter Number	SSI Number	Default	Page Number
Imaging Preferences				
Operational Modes	N/A	N/A	N/A	7-4
Image Capture Illumination	361	F0h 69h	Enable	7-5
Image Capture Autoexposure	360	F0h 68h	Enable	7-5
Fixed Exposure	567	F4h F1h 37h	100	7-6
Gain / Exposure Priority for Snapshot Mode	562	F1h 32h	Autodetect	7-7
Snapshot Mode Timeout	323	F0h 43h	0 (30 Seconds)	7-8
Snapshot Aiming Pattern	300	F0h 2Ch	Enable	7-9
Silence Operational Mode Changes	1293	F8h 05h 0Dh	Disable (Do Not Silence)	7-9
Image Cropping	301	F0h 2Dh	Disable	7-10
Crop to Pixel Addresses	315 316 317 318	F4h F0h 3Bh F4h F0h 3Ch F4h F0h 3Dh F4h F0h 3Eh	0 top 0 left 959 bottom 1279 right	7-11
Image Size (Number of Pixels)	302	F0h 2Eh	Full	7-13
Image Brightness (Target White)	390	F0h 86h	180	7-14
JPEG Image Options	299	F0h 2Bh	Quality	7-14
JPEG Target File Size	561	F1h 31h	160 kB	7-15
JPEG Quality and Size Value	305	F0h 31h	65	7-15
Image Enhancement	564	F1h 34h	Low	7-16
Image File Format Selection	304	F0h 30h	JPEG	7-17
Image Rotation	665	F1h 99h	0°	7-18
Bits per Pixel (BPP)	303	F0h 2Fh	8 BPP	7-19
Signature Capture (DS36X8 HP Only)	93	5Dh	Disable	7-20
Signature Capture Image File Format Selection (DS36X8 HP Only)	313	F0h 39h	JPEG	7-21
Signature Capture Bits per Pixel (BPP) (DS36X8 HP Only)	314	F0h 3Ah	8 BPP	7-22

Table A-1 Parameter Defaults (Continued)

Parameter	Parameter Number	SSI Number	Default	Page Number
Signature Capture Width (DS36X8 HP Only)	366	F4h F0h 6Eh	400	7-23
Signature Capture Height (DS36X8 HP Only)	367	F4h F0h 6Fh	100	7-23
Signature Capture JPEG Quality (DS36X8 HP Only)	421	F0h A5h	65	7-24
Video View Finder	324	F0h 44h	Disable	7-24
Video View Finder Image Size	329	F0h 49h	1700 bytes	7-25
USB Host Parameters				
USB Device Type	N/A	N/A	USB Keyboard HID	8-5
Symbol Native API (SNAPI) Status Handshaking	N/A	N/A	Enable	8-8
USB Keystroke Delay	N/A	N/A	No Delay	8-9
USB CAPS Lock Override	N/A	N/A	Disable	8-9
USB Ignore Unknown Characters	N/A	N/A	Send Bar Codes with Unknown Characters	8-10
USB Convert Unknown to Code 39	N/A	N/A	Disable	8-10
Emulate Keypad	N/A	N/A	Enable	8-11
Emulate Keypad with Leading Zero	N/A	N/A	Enable	8-11
Quick Keypad Emulation	N/A	N/A	Enable	8-12
USB FN1 Substitution	N/A	N/A	Disable	8-12
Function Key Mapping	N/A	N/A	Disable	8-13
Simulated Caps Lock	N/A	N/A	Disable	8-13
Convert Case	N/A	N/A	None	8-14
USB Static CDC	N/A	N/A	Enable	8-15
Ignore Beep Directive	N/A	N/A	Enable (Ignore)	8-16
Ignore Bar Code Configuration	N/A	N/A	Enable (Ignore)	8-16
USB Polling Interval	N/A	N/A	3 msec	8-17
USB Fast HID	N/A	N/A	Enable	8-19
IBM Specification Version	N/A	N/A	Version 2.2	8-19

Table A-1 *Parameter Defaults (Continued)*

Parameter	Parameter Number	SSI Number	Default	Page Number
SSI Parameters				
Select SSI Host	N/A	N/A	N/A	9-11
Baud Rate	156	9Ch	9600	9-12
Parity	158	9Eh	None	9-13
Check Parity	151	97h	Disable	9-14
Stop Bits	157	9Dh	1	9-15
Software Handshaking	159	9Fh	ACK/NAK	9-16
Host RTS Line State	154	9Ah	Low	9-17
Decode Data Packet Format	238	EEh	Send Raw Decode Data	9-17
Host Serial Response Time-out	155	9Bh	2 Seconds	9-19
Host Character Time-out	239	EFh	200 msec	9-20
Multipacket Option	334	F0h 4Eh	Option 1	9-21
Interpacket Delay	335	F0h 4Fh	0 msec	9-22
Decode Event	256	F0h 00h	Disable	9-23
Boot Up Event	258	F0h 02h	Disable	9-24
Parameter Event	259	F0h 03h	Disable	9-24
RS-232 Host Parameters				
RS-232 Host Types	N/A	N/A	Standard	10-7
Baud Rate	N/A	N/A	9600	10-10
Parity Type	N/A	N/A	None	10-11
Stop Bits	N/A	N/A	1 Stop Bit	10-12
Data Bits	N/A	N/A	8-Bit	10-12
Check Receive Errors	N/A	N/A	Enable	10-13
Hardware Handshaking	N/A	N/A	None	10-13
Software Handshaking	N/A	N/A	None	10-15
Host Serial Response Time-out	N/A	N/A	2 Seconds	10-17
RTS Line State	N/A	N/A	Low RTS	10-18
Intercharacter Delay	N/A	N/A	0 msec	10-18
Nixdorf Beep/LED Options	N/A	N/A	Normal Operation	10-19

Table A-1 *Parameter Defaults (Continued)*

Parameter	Parameter Number	SSI Number	Default	Page Number
Ignore Unknown Characters	N/A	N/A	Send Bar Code	10-20
Beep on <BEL>	N/A	N/A	Disable	10-20
Datalogic Host Format	2253	F8 08 CD	Enable	10-21
Datalogic Supported Commands	2260	F8 08 D4	Disable	10-22
IBM 468X/469X Host Parameters				
Port Address	N/A	N/A	None Selected	11-5
Convert Unknown to Code 39	N/A	N/A	Disable	11-6
Beep Directive	N/A	N/A	Ignore	11-6
Bar Code Configuration Directive	N/A	N/A	Ignore	11-7
IBM-485 Specification Version	1729	F8h 06h C1h	IBM-485 Specification Version	11-7
Keyboard Wedge Host Parameters				
Keyboard Wedge Host Type	N/A	N/A	IBM AT Notebook	12-5
Ignore Unknown Characters	N/A	N/A	Send Bar Codes with Unknown Characters	12-5
Keystroke Delay	N/A	N/A	No Delay	12-6
Intra-Keystroke Delay	N/A	N/A	Disable	12-6
Alternate Numeric Keypad Emulation	N/A	N/A	Enable	12-7
Quick Keypad Emulation	N/A	N/A	Enable	12-7
Simulated Caps Lock	N/A	N/A	Disable	12-8
Caps Lock Override	N/A	N/A	Disable	12-8
Convert Wedge Case	N/A	N/A	No Convert	12-9
Function Key Mapping	N/A	N/A	Disable	12-9
FN1 Substitution	N/A	N/A	Disable	12-10
Send Make and Break	N/A	N/A	Send Make and Break Scan Codes	12-10
Enable/Disable All Code Types				13-8
1D Symbologies				
UPC/EAN				
UPC-A	1	01h	Enable	13-9

Table A-1 *Parameter Defaults (Continued)*

Parameter	Parameter Number	SSI Number	Default	Page Number
UPC-E	2	02h	Enable	13-9
UPC-E1	12	0Ch	Disable	13-10
EAN-8/JAN 8	4	04h	Enable	13-10
EAN-13/JAN 13	3	03h	Enable	13-11
Bookland EAN	83	53h	Disable	13-11
Decode UPC/EAN/JAN Supplementals (2 and 5 digits)	16	10h	Ignore	13-12
User-Programmable Supplementals	579	F1h 43h	000	13-15
Supplemental 1:	580	F1h 44h		
Supplemental 2:				
UPC/EAN/JAN Supplemental Redundancy	80	50h	10	13-15
Decode UPC/EAN/JAN Supplemental AIM ID	672	F1h A0h	Combined	13-15
UPC Reduced Quiet Zone	1289	F8h 05h 09h	Disable	13-17
Transmit UPC-A Check Digit	40	28h	Enable	13-17
Transmit UPC-E Check Digit	41	29h	Enable	13-18
Transmit UPC-E1 Check Digit	42	2Ah	Enable	13-18
UPC-A Preamble	34	22h	System Character	13-19
UPC-E Preamble	35	23h	System Character	13-20
UPC-E1 Preamble	36	24h	System Character	13-21
Convert UPC-E to A	37	25h	Disable	13-22
Convert UPC-E1 to A	38	26h	Disable	13-22
EAN-8/JAN-8 Extend	39	27h	Disable	13-23
Bookland ISBN Format	576	F1h 40h	ISBN-10	13-23
UCC Coupon Extended Code	85	55h	Disable	13-24
Coupon Report	730	F1h DAh	New Coupon Format	13-25
ISSN EAN	617	F1h 69h	Disable	13-25
Code 128				
Code 128	8	08h	Enable	13-26

Table A-1 *Parameter Defaults (Continued)*

Parameter	Parameter Number	SSI Number	Default	Page Number
Set Length(s) for Code 128	209, 210	D1h, D2h	1 to 55	13-27
GS1-128 (formerly UCC/EAN-128)	14	0Eh	Enable	13-29
ISBT 128	84	54h	Disable	13-29
ISBT Concatenation	577	F1h 41h	Autodiscriminate	13-30
Check ISBT Table	578	F1h 42h	Enable	13-31
ISBT Concatenation Redundancy	223	DFh	10	13-31
Code 128 Security Level	751	F1h EFh	Security Level 1	13-32
Code 128 Reduced Quiet Zone	1208	F8h 04h B8h	Disable	13-33
Ignore Code 128 <FNC4>	1254	F8h 04h E6h	Disable	13-33
Code 39				
Code 39	0	00h	Enable	13-34
Trioptic Code 39	13	0Dh	Disable	13-34
Convert Code 39 to Code 32 (Italian Pharmacy Code)	86	56h	Disable	13-35
Code 32 Prefix	231	E7h	Disable	13-35
Set Length(s) for Code 39	18, 19	12h, 13h	1 to 55	13-36
Code 39 Check Digit Verification	48	30h	Disable	13-37
Transmit Code 39 Check Digit	43	2Bh	Disable	13-37
Code 39 Full ASCII Conversion	17	11h	Disable	13-38
Code 39 Security Level	750	F1h EEh	Security Level 1	13-39
Code 39 Reduced Quiet Zone	1209	F8h 04h B9h	Disable	13-40
Code 93				
Code 93	9	09h	Enable	13-40
Set Length(s) for Code 93	26, 27	1Ah, 1Bh	1 to 55	13-41
Code 11				
Code 11	10	0Ah	Disable	13-42
Set Lengths for Code 11	28, 29	1Ch, 1Dh	4 to 55	13-43
Code 11 Check Digit Verification	52	34h	Disable	13-44

Table A-1 *Parameter Defaults (Continued)*

Parameter	Parameter Number	SSI Number	Default	Page Number
Transmit Code 11 Check Digit(s)	47	2Fh	Disable	13-45
Interleaved 2 of 5 (ITF)				
Interleaved 2 of 5 (ITF)	6	06h	Disable	13-45
Set Lengths for I 2 of 5	22, 23	16h, 17h	6 to 55	13-46
I 2 of 5 Check Digit Verification	49	31h	Disable	13-47
Transmit I 2 of 5 Check Digit	44	2Ch	Disable	13-48
Convert I 2 of 5 to EAN 13	82	52h	Disable	13-48
I 2 of 5 Security Level	1121	F8h 04h 61h	Security Level 1	13-49
I 2 of 5 Reduced Quiet Zone	1210	F8h 04h BAh	Disable	13-50
Discrete 2 of 5 (DTF)				
Discrete 2 of 5	5	05h	Disable	13-50
Set Length(s) for D 2 of 5	20, 21	14h 15h	1 to 55	13-51
Codabar (NW - 7)				
Codabar	7	07h	Enable	13-52
Set Lengths for Codabar	24, 25	18h, 19h	4 to 55	13-53
CLSI Editing	54	36h	Disable	13-55
NOTIS Editing	55	37h	Disable	13-55
Codabar Security Level	1776	F8h 06h F0h	Security Level 1	13-56
Codabar Upper or Lower Case Start/Stop Characters Detection	855	F2h 57h	Upper Case	13-58
Codabar Mod 16 Check Digit Verification	1784	F8h 06h F8h	Disable	13-58
Transmit Codabar Check Digit	704	F1h C0h	Disable	13-59
MSI				
MSI	11	0Bh	Disable	13-60
Set Length(s) for MSI	30, 31	1Eh, 1Fh	4 to 55	13-61
MSI Check Digits	50	32h	One	13-62
Transmit MSI Check Digit	46	2Eh	Disable	13-63
MSI Check Digit Algorithm	51	33h	Mod 10/Mod 10	13-64
MSI Reduced Quiet Zone	1392	F8h 05h 70h	Disable	13-64

Table A-1 Parameter Defaults (Continued)

Parameter	Parameter Number	SSI Number	Default	Page Number
Chinese 2 of 5				
Chinese 2 of 5	408	F0h 98h	Disable	13-65
Matrix 2 of 5				
Matrix 2 of 5	618	F1h 6Ah	Disable	13-66
Matrix 2 of 5 Lengths	619 620	F1h 6Bh F1h 6Ch	4 to 55	13-68
Matrix 2 of 5 Check Digit	622	F1h 6Eh	Disable	13-68
Transmit Matrix 2 of 5 Check Digit	623	F1h 6Fh	Disable	13-68
Korean 3 of 5				
Korean 3 of 5	581	F1h 45h	Disable	13-69
Inverse 1D	586	F1h 4Ah	Regular	13-70
GS1 DataBar				
GS1 DataBar-14	338	F0h 52h	Enable	13-71
GS1 DataBar Limited	339	F0h 53h	Enable	13-71
GS1 DataBar Expanded	340	F0h 54h	Enable	13-72
Convert GS1 DataBar to UPC/EAN	397	F0h 8Dh	Disable	13-72
GS1 DataBar Security Level	1706	F8h 06h AAh	Level 1	13-73
GS1 DataBar Limited Margin Check	728	F1h D8h	Level 3	13-74
Composite				
Composite CC-C	341	F0h 55h	Disable	13-75
Composite CC-A/B	342	F0h 56h	Disable	13-75
Composite TLC-39	371	F0h 73h	Disable	13-76
Composite Inverse	1113	F8h 04h 59h	Regular	13-77
UPC Composite Mode	344	F0h 58h	UPC Never Linked	13-78
Composite Beep Mode	398	F0h 8Eh	Beep As Each Code Type is Decoded	13-79
GS1-128 Emulation Mode for UCC/EAN Composite Codes	427	F0h ABh	Disable	13-79

Table A-1 *Parameter Defaults (Continued)*

Parameter	Parameter Number	SSI Number	Default	Page Number
2D Symbologies				
PDF417	15	0Fh	Enable	13-80
MicroPDF417	227	E3h	Disable	13-80
Code 128 Emulation	123	7Bh	Disable	13-81
Data Matrix	292	F0h 24h	Enable	13-82
GS1 Data Matrix	1336	F8h 05h 38h	Disable	13-82
Data Matrix Inverse	588	F1h 4Ch	Inverse Autodetect	13-83
Maxicode	294	F0h 26h	Disable	13-84
QR Code	293	F0h 25h	Enable	13-84
GS1 QR	1343	F8h 05h 3Fh	Disable	13-85
MicroQR	573	F1h 3Dh	Enable	13-85
Linked QR Mode	1847	737h	Linked QR Only	13-86
Aztec	574	F1h 3Eh	Enable	13-87
Aztec Inverse	589	F1h 4Dh	Inverse Autodetect	13-88
Han Xin	1167	F8h 04h 8Fh	Disable	13-89
Han Xin Inverse	1168	F8h 04h 90h	Regular	13-89
Grid Matrix	1718	F8h 06h B6h	Disable	13-90
Grid Matrix Inverse	1719	F8h 06h B7h	Regular	13-91
Grid Matrix Mirrored	1736	F8h 06h C8h	Non-Mirrored	13-92
DotCode	1906	F8 07 72h	Disable	13-93
DotCode Inverse	1907	F8 07 73h	Autodetect	13-94
DotCode Mirrored	1908	F8 07 74h	Autodetect	13-95
DotCode Prioritize	1937	F8 07 91h	Disable	13-96
Postal Codes				
US Postnet	89	59h	Disable	13-97
US Planet	90	5Ah	Disable	13-97
Transmit US Postal Check Digit	95	5Fh	Enable	13-98
UK Postal	91	5Bh	Disable	13-98
Transmit UK Postal Check Digit	96	60h	Enable	13-99

Table A-1 *Parameter Defaults (Continued)*

Parameter	Parameter Number	SSI Number	Default	Page Number
Japan Postal	290	F0h 22h	Disable	13-99
Australia Post	291	F0h 23h	Disable	13-100
Australia Post Format	718	F1h CEh	Autodiscriminate	13-101
Netherlands KIX Code	326	F0h 46h	Disable	13-102
USPS 4CB/One Code/Intelligent Mail	592	F1h 50h	Disable	13-102
UPU FICS Postal	611	F1h 63h	Disable	13-103
Mailmark	1337	F8h 05h 08h	Disable	13-103
Symbology-Specific Security Levels				
Redundancy Level	78	4Eh	1	13-104
Security Level	77	4Dh	1	13-106
1D Quiet Zone Level	1288	F8h 05h 08h	1	13-107
Intercharacter Gap Size	381	F0h 7Dh	Normal	13-108
Report Version				13-108
Macro PDF				
Flush Macro PDF Buffer	N/A	N/A	N/A	13-109
Abort Macro PDF Entry	N/A	N/A	N/A	13-109
Intelligent Document Capture (IDC)				
IDC Operating Mode	594	F1h 52h	Off	14-5
IDC Symbology	655	F1h 8Fh	001	14-6
IDC X Coordinate	596	F4h F1h 54h	-151	14-7
IDC Y Coordinate	597	F4h F1h 55h	-050	14-7
IDC Width	598	F1h 56h	0300	14-8
IDC Height	599	F1h 57h	0050	14-8
IDC Aspect	595	F1h 53h	000	14-9
IDC File Format Selector	601	F1h 59h	JPEG	14-10
IDC Bits Per Pixel	602	F1h 5Ah	8 BPP	14-11
IDC JPEG Quality	603	F1h 5Bh	065	14-12
IDC Find Box Outline	727	F1h D7h	Disable	14-12

Table A-1 *Parameter Defaults (Continued)*

Parameter	Parameter Number	SSI Number	Default	Page Number
IDC Minimum Text Length	656	F1h 90h	00	14-13
IDC Maximum Text Length	657	F1h 91h	00	14-14
IDC Captured Image Brighten	654	F1h 8Eh	Enable	14-15
IDC Captured Image Sharpen	658	F1h 92h	Enable	14-16
IDC Border Type	829	F2h 3Dh	None	14-17
IDC Delay Time	830	F2h 3Eh	000	14-18
IDC Zoom Limit	651	F1h 8Bh	000	14-18
IDC Maximum Rotation	652	F1h 8Ch	00	14-19
Digimarc Barcode				
Digimarc Digital Watermarks	1687	F8h 06h 97h	Disable	15-2
OCR Programming Parameters				
OCR-A	680	F1h A8h	Disable	17-3
OCR-A Variant	684	F1h ACh	Full ASCII	17-4
OCR-B	681	F1h A9h	Disable	17-6
OCR-B Variant	685	F1h ADh	Full ASCII	17-7
MICR E13B	682	F1h AAh	Disable	17-11
US Currency	683	F1h ABh	Disable	17-12
OCR Orientation	687	F1h AFh	0°	17-12
OCR Lines	691	F1h B3h	1	17-14
OCR Minimum Characters	689	F1h B1h	3	17-14
OCR Maximum Characters	690	F1h B2h	100	17-15
OCR Subset	686	F1h AEh	Selected font variant	17-15
OCR Quiet Zone	695	F1h B7h	50	17-16
OCR Template	547	F1h 23h	99999999	17-17
OCR Check Digit Modulus	688	F1h B0h	1	17-27
OCR Check Digit Multiplier	700	F1h BCh	121212121212	17-28
OCR Check Digit Validation	694	F1h B6h	None	17-29
Inverse OCR	856	F2h 58h	Regular	17-34
OCR Redundancy	1770	F8h 06h EAh	Level 1	17-35

APPENDIX B COUNTRY CODES

Introduction

This chapter provides instructions for programming the keyboard to interface with a USB or keyboard wedge host. The host powers the scanner. For host setup information, see [Chapter 8, USB Interface](#) and [Chapter 12, Keyboard Wedge Interface](#).

To select a code page for the country keyboard type, see [Appendix C, Country Code Pages](#).

Throughout the programming barcode menus, default values are indicated with asterisks (*).



*Indicates Default — * **US English (North American)** — Feature/Option

USB and Keyboard Wedge Country Keyboard Types (Country Codes)

Scan the barcode corresponding to the keyboard type. For a USB host, this setting applies only to the USB Keyboard (HID) device. If the keyboard type is not listed, see [Emulate Keypad on page 8-11](#) for the USB HID host. For a keyboard wedge host, see [Alternate Numeric Keypad Emulation on page 12-7](#).



NOTE When changing USB country keyboard types the digital scanner automatically resets and issues the standard startup beep sequences.



NOTE For best results when using international keyboards, enable [Quick Keypad Emulation on page 8-12](#).



IMPORTANT 1. Some country keyboard barcode types are specific to certain Windows Operating Systems (i.e., XP, and Win 7 or higher). Bar codes requiring a specific Windows OS are noted so in their barcode captions.

2. Use the **French International** barcode for Belgian French keyboards.



* US English (North American)



US English (Mac)



Albanian

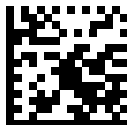

Arabic (101)

Country Codes (Continued)

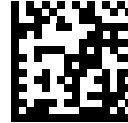

Arabic (102)

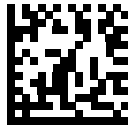

Arabic (102) AZERTY



Azeri (Latin)



Azeri (Cyrillic)



Belarusian



Bosnian (Latin)

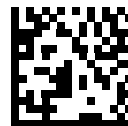

Bosnian (Cyrillic)

Country Codes (Continued)



Bulgarian (Latin)



**Bulgarian Cyrillic (Typewriter)
(Bulgarian -Windows XP
Typewriter - Win 7 or higher)**



Canadian French Win7



Canadian French (Legacy)



Canadian Multilingual Standard



Chinese (ASCII)

Country Codes (Continued)

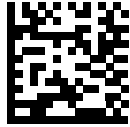

Chinese (Simplified) *



Chinese (Traditional) *

* For CJK keyboard types, see [Appendix D, CJK Decode Control](#).



Croatian

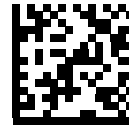

Czech



Czech (Programmer)



Czech (QWERTY)

Country Codes (Continued)



Danish



Dutch (Netherlands)

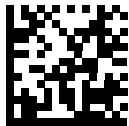

Estonian



Faeroese

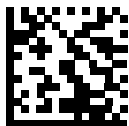

Finnish

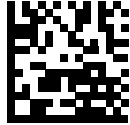
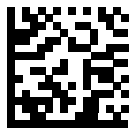

French (France)

Country Codes (Continued)**French International
(Belgian French)****French (Canada) 95/98****French (Canada) 2000/XP ***

* Note that there is also a country code barcode for [Canadian Multilingual Standard on page B-4](#). Be sure to select the appropriate barcode for your host system.

**Galician****German****Greek Latin**

Country Codes (Continued)



Greek (220) Latin



Greek (319) Latin



Greek



Greek (220)



Greek (319)



Greek Polytonic

Country Codes (Continued)

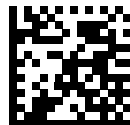

Hebrew Israel



Hungarian

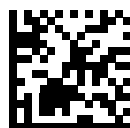

Hungarian_101KEY



Icelandic



Irish



Italian

Country Codes (Continued)



Italian (142)



Japanese (ASCII)



Japanese (SHIFT-JIS) *

* For CJK keyboard types, see [Appendix D, CJK Decode Control](#).



Kazakh



Korean (ASCII)

Country Codes (Continued)



Korean (Hangul) *

* For CJK keyboard types, see [Appendix D, CJK Decode Control](#).



Kyrgyz



Latin American



Latvian



Latvian (QWERTY)



Lithuanian

Country Codes (Continued)



Lithuanian (IBM)

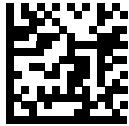

Macedonian (FYROM)



Maltese_47KEY



Mongolian



Norwegian



Polish (214)

Country Codes (Continued)



Polish (Programmer)



Portuguese (Brazil)
(Windows XP)



Portuguese (Brazilian ABNT)

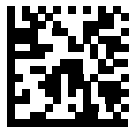

Portuguese (Brazilian ABNT2)



Portuguese (Portugal)

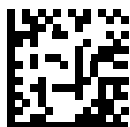

Romanian
(Windows XP)

Country Codes (Continued)



Romanian (Legacy)
(Win 7 or higher)



Romanian (Standard)
(Win 7 or higher)



Romanian (Programmer)
(Win 7 or higher)

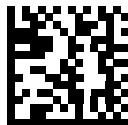

Russian



Russian (Typewriter)



Serbian (Latin)

Country Codes (Continued)



Serbian (Cyrillic)



Slovak



Slovak (QWERTY)



Slovenian



Spanish

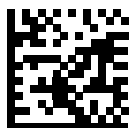

Spanish (Variation)

Country Codes (Continued)



Swedish



Swiss French



Swiss German



Tatar



Thai (Kedmanee)



Turkish F

Country Codes (Continued)



Turkish Q



UK English



Ukrainian



US Dvorak



US Dvorak Left



US Dvorak Right

Country Codes (Continued)



US International



Uzbek



Vietnamese

APPENDIX C COUNTRY CODE PAGES

Introduction

This chapter provides barcodes for selecting code pages for the country keyboard type selected in [Appendix C, Country Code Pages](#). If the default code page in [Table C-1](#) is appropriate for your selected country keyboard type, you do not need to scan a country code page barcode.



NOTE ADF rules can also specify a code page based on the symbology and other ADF criteria. Refer to the *Advanced Data Formatting Programmer Guide*.

Country Code Page Defaults

[Table C-1](#) lists the code page default for each country keyboard.

Table C-1 *Country Code Page Defaults*

Country Keyboard	Code Page Default
US English (North American)	Windows 1252
US English (Mac)	Mac CP10000
Albanian	Windows 1250
Arabic 101	Windows 1256
Arabic 102	Windows 1256
Arabic 102 AZERTY	Windows 1256
Azeri Latin	Windows 1254
Azeri Cyrillic	Windows 1251
Belarusian	Windows 1251
Bosnian Latin	Windows 1250

Table C-1 Country Code Page Defaults (Continued)

Country Keyboard	Code Page Default
Bosnian Cyrillic	Windows 1251
Bulgarian Latin	Windows 1250
Bulgarian Cyrillic	Windows 1251
Canadian French Win7	Windows 1252
Canadian French (Legacy)	Windows 1252
Canadian Multilingual	Windows 1252
Croatian	Windows 1250
Chinese ASCII	Windows 1252
Chinese (Simplified)	Windows 936, GBK
Chinese (Traditional)	Windows 950, Big5
Czech	Windows 1250
Czech Programmers	Windows 1250
Czech QWERTY	Windows 1250
Danish	Windows 1252
Dutch Netherland	Windows 1252
Estonian	Windows 1257
Faeroese	Windows 1252
Finnish	Windows 1252
French (France)	Windows 1252
French (Canada) 95/98	Windows 1252
French (Canada) 2000/XP	Windows 1252
French International (Belgian French)	Windows 1252
Galician	Windows 1252
German	Windows 1252
Greek Latin	Windows 1252
Greek220 Latin	Windows 1253
Greek319 Latin	Windows 1252
Greek	Windows 1253
Greek220	Windows 1253
Greek319	Windows 1253

Table C-1 Country Code Page Defaults (Continued)

Country Keyboard	Code Page Default
Greek Polytonic	Windows 1253
Hebrew Israel	Windows 1255
Hungarian	Windows 1250
Hungarian_101KEY	Windows 1250
Icelandic	Windows 1252
Irish	Windows 1252
Italian	Windows 1252
Italian_142	Windows 1252
Japanese ASCII	Windows 1252
Japanese (Shift-JIS)	Windows 932, Shift-JIS
Kazakh	Windows 1251
Korean ASCII	Windows 1252
Korean (Hangul)	Windows 949, Hangul
Kyrgyz Cyrillic	Windows 1251
Latin America	Windows 1252
Latvian	Windows 1257
Latvian QWERTY	Windows 1257
Lithuanian	Windows 1257
Lithuanian_IBM	Windows 1257
Macedonian -FYROM	Windows 1251
Maltese_47KEY	Windows 1252
Mongolian-Cyrillic	Windows 1251
Norwegian	Windows 1252
Polish_214	Windows 1250
Polish Programmer	Windows 1250
Portuguese Brazil	Windows 1252
Portuguese Brazilian ABNT	Windows 1252
Portuguese Brazilian ABNT2	Windows 1252
Portuguese Portugal	Windows 1252
Romanian	Windows 1250

Table C-1 Country Code Page Defaults (Continued)

Country Keyboard	Code Page Default
Romanian Legacy	Windows 1250
Romanian Standard	Windows 1250
Romanian Programmer	Windows 1250
Russian	Windows 1251
Russian Typewriter	Windows 1251
Serbian Latin	Windows 1250
Serbian Cyrillic	Windows 1251
Slovak	Windows 1250
Slovak QWERTY	Windows 1250
Slovenian	Windows 1250
Spanish	Windows 1252
Spanish Variation	Windows 1252
Swedish	Windows 1252
Swiss French	Windows 1252
Swiss German	Windows 1252
Tatar	Windows 1251
Thai-Kedmanee	Windows 874
Turkish F	Windows 1254
Turkish Q	Windows 1254
Ukrainian	Windows 1251
United Kingdom	Windows 1252
United States	Windows 1252
US Dvorak	Windows 1252
US Dvorak Left Hand	Windows 1252
US Dvorak Right Hand	Windows 1252
US International	Windows 1252
Uzbek Cyrillic	Windows 1251
Vietnamese	Windows 1258

Country Code Page Bar Codes

Scan the barcode corresponding to the country keyboard code page.



Windows 1250
Latin 2, Central European



Windows 1251
Cyrillic, Slavic



Windows 1252
Latin 1, Western European



Windows 1253
Greek

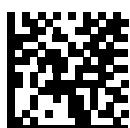

Windows 1254
Latin 5, Turkish

Country Code Pages (Continued)



Windows 1255
Hebrew



Windows 1256
Arabic

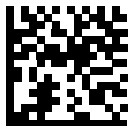

Windows 1257
Baltic



Windows 1258
Vietnamese



Windows 874
Thai

Country Code Pages (Continued)



**Windows 20866
Cyrillic KOI8-R**



**Windows 932
Japanese Shift-JIS**

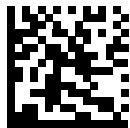

**Windows 936
Simplified Chinese GBK**



**Windows 54936
Simplified Chinese GB18030**



**Windows 949
Korean Hangul**

Country Code Pages (Continued)



Windows 950
Traditional Chinese Big5



MS-DOS 437
Latin US



MS-DOS 737
Greek

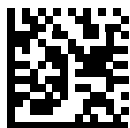

MS-DOS 775
Baltic



MS-DOS 850
Latin 1

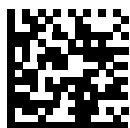

MS-DOS 852
Latin 2

Country Code Pages (Continued)

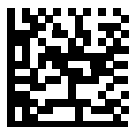

MS-DOS 855
Cyrillic



MS-DOS 857
Turkish



MS-DOS 860
Portuguese



MS-DOS 861
Icelandic

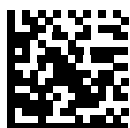

MS-DOS 862
Hebrew

Country Code Pages (Continued)



MS-DOS 863
French Canada



MS-DOS 865
Nordic



MS-DOS 866
Cyrillic



MS-DOS 869
Greek 2



ISO 8859-1
Latin 1, Western European

Country Code Pages (Continued)



ISO 8859-2
Latin 2, Central European



ISO 8859-3
Latin 3, South European



ISO 8859-4
Latin 4, North European



ISO 8859-5
Cyrillic



ISO 8859-6
Arabic

Country Code Pages (Continued)

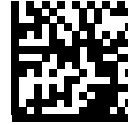

ISO 8859-7
Greek

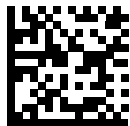

ISO 8859-8
Hebrew

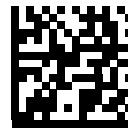

ISO 8859-9
Latin 5, Turkish



ISO 8859-10
Latin 6, Nordic



ISO 8859-11
Thai

Country Code Pages (Continued)



ISO 8859-13
Latin 7, Baltic

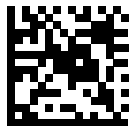

ISO 8859-14
Latin 8, Celtic



ISO 8859-15
Latin 9

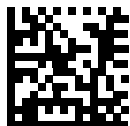

ISO 8859-16
Latin 10, South-Eastern European



UTF-8

Country Code Pages (Continued)



UTF-16LE
UTF-16 Little Endian



UTF-16BE
UTF-16 Big Endian

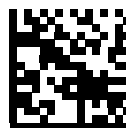

Mac CP10000
Roman

APPENDIX D CJK DECODE CONTROL

Introduction

This appendix describes control parameters for CJK (Chinese, Japanese, Korean) barcode decode through USB HID Keyboard Emulation mode.

✓ **NOTE** Because ADF does not support CJK character processing, there is no format manipulation for CJK output.

CJK Control Parameters

Unicode Output Control

Parameter # 973

For a Unicode encoded CJK barcode, select one of the following options for unicode output:

- **Universal Output to Unicode and MBCS Application** - This default method applies to Unicode and MBCS expected applications, such as MS Word and Notepad on a Windows host.
- ✓ **NOTE** To support Unicode universal output, set up the registry table for the Windows host. See [Unicode/CJK Decode Setup with Windows Host on page D-7](#).
- **Output to Unicode Application Only** - This method applies only to Unicode expected applications, such as MS Word and WordPad, but not Notepad.



* Universal Output
(0)



Unicode Application Only
(1)

CJK Output Method to Windows Host

Parameter # 972

For a national standard encoded CJK barcode, select one of the following options for CJK output to a Windows host:

- **Universal CJK Output** - This is the default universal CJK output method for US English IME or Chinese/Japanese/Korean ASCII IME on a Windows host. This method converts CJK characters to Unicode and emulates the characters when transmitting to the host. Use the [Unicode Output Control](#) parameter to control Unicode output.
- ✓ **NOTE** To support universal CJK output, set up the registry table for the Windows host. See [Unicode/CJK Decode Setup with Windows Host on page D-7](#).
- **Other options for CJK output** - With the following methods, the scanner sends the CJK character hexadecimal internal code (Nei Ma) value to host, or converts the CJK character to Unicode and sends the hexadecimal Unicode value to host. When using these methods, the Windows host must select the corresponding IME to accept the CJK character. See [Unicode/CJK Decode Setup with Windows Host on page D-7](#).
 - **Japanese Unicode Output**
 - **Simplified Chinese GBK Code Output**
 - **Simplified Chinese Unicode Output**
 - **Korean Unicode Code Output**
 - **Traditional Chinese Big5 Code Output** (Windows XP)
 - **Traditional Chinese Big5 Code Output** (Windows 7)
 - **Traditional Chinese Unicode Code Output** (Windows XP)
 - **Traditional Chinese Unicode Code Output** (Windows 7)
- ✓ **NOTE** The Unicode emulate output method depends on the host system (Windows XP or Windows 7).



* Universal CJK Output
(0)



Japanese Unicode Output
(34)

(for Japanese Unicode Output, select Simplified Chinese Unicode IME on the Windows host)

CJK Output Method to Windows Host (continued)



**Chinese (Simplified) GBK Output
(1)**



**Chinese (Simplified) Unicode Output
(2)**

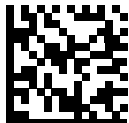

**Korean Unicode Output
(50)**

(for Korean Unicode Output, select Simplified Chinese Unicode IME on the Windows host)



**Chinese (Traditional) Big5 Output (Windows XP)
(17)**



**Chinese (Traditional) Big5 Output (Windows 7)
(19)**

CJK Output Method to Windows Host (continued)

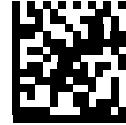

Chinese (Traditional) Unicode Output (Windows XP)
(18)

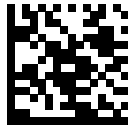

Chinese (Traditional) Unicode Output (Windows 7)
(20)

Non-CJK UTF Bar Code Output

Parameter # 960

Some country keyboard type layouts contain characters that do not exist in the default code page (see [Country Keyboard Type Missing Characters on page D-6](#)). Although the default code page can not encode these characters in a barcode, they can be encoded in the UTF-8 barcode. Scan this parameter barcode to output the Unicode values by emulation mode.

- ✓ **NOTE** Use this special country keyboard type to decode the non-CJK UTF-8 barcode. After decoding, re-configure the scanner to use the original country keyboard type.

Use US English IME on Windows. See [Unicode Output Control on page D-2](#).

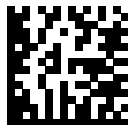

Non-CJK UTF-8 Emulation Output

Country Keyboard Type Missing Characters

Country keyboard type: **Tatar, Uzbek, Mongolian, Kyrgyz, Kazakh and Azeri**

Default code page: CP1251

Missing characters:

ƒ	F
х	Ҥ
к	Қ
h	Һ
ө	Ө
ә	Ә
Ү	У
н	Ң
ж	Ж
Ғ	
н	Ң
Ү	У
к	Қ
ч	Ҹ
к	Қ

Country keyboard type: **Romanian (Standard)**

Default code page: CP1250

Missing characters:

ș	Ș
ț	Ț

Country keyboard type: **Portuguese-Brazilian (ABNT), Portuguese-Brazilian (ABNT2)**

Default code page: CP1252

Missing character: **Ç**

Country keyboard type: **Azeri-Latin**

Default code page: CP1254

Missing characters: ә, Ә

Unicode/CJK Decode Setup with Windows Host

This section describes how to set up CJK decode with a Windows host.

Setting Up the Windows Registry Table for Unicode Universal Output

To support the Unicode universal output method, set up the Windows host registry table as follows:

1. Select **Start > Run > regedt32** to start the registry editor.
2. Under **HKEY_Current_User\Control Panel\Input Method**, set **EnableHexNumpad** to **1** as follows:
[HKEY_CURRENT_USER\Control Panel\Input Method]
"EnableHexNumpad"="1"
If this key does not exist, add it as type **REG_SZ** (string value).
3. Reboot the computer to implement the registry change.

Adding CJK IME on Windows

To add the desired CJK input language:

1. Click **Start > Control Panel**.
2. If the Control Panel opens in category view, select **Switch to Classic View** in the top left corner.
3. Select **Regional and Language Options**.
4. Click the **Language** tab.
5. Under **Supplemental Language Support**, select the **Install Files for East Asian Languages** check box if not already selected, and click **Apply**. This may require a Windows installation CD to install the required files. This step ensures that the East Asian Languages (CJK) are available.
6. Under **Text Services and Input Language**, click **Details**.
7. Under **Installed Services**, click **Add**.
8. In the **Add Input Language** dialog box, choose the CJK input language and keyboard layout or Input Method Editor (IME) to add.
9. Click **OK** twice. The language indicator appears in the system tray (at bottom right corner of the desktop by default). To switch between input languages (keyboard languages) select the language indicator in the system tray.
10. Select the language indicator in the system tray to select the desired country keyboard type.
11. Verify that the characters displayed on each country's keyboard appear.

Selecting the Simplified Chinese Input Method on the Host

To select the Simplified Chinese input method:

- Select Unicode/GBK input on Windows XP: **Chinese (Simplified) - NeiMa**, then click the input bar to select **Unicode** or **GBK NeiMa** input.

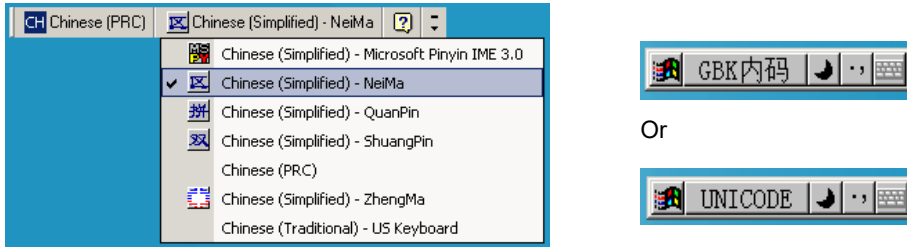

Figure D-1 Unicode/GBK Input on Windows XP

- Select Unicode/GBK input on Windows 7: **Chinese (Simplified) - Microsoft Pinyin New Experience Input Style**, then select **Tool Menu > Secondary Inputs > Unicode Input** or **GB Code Input**.

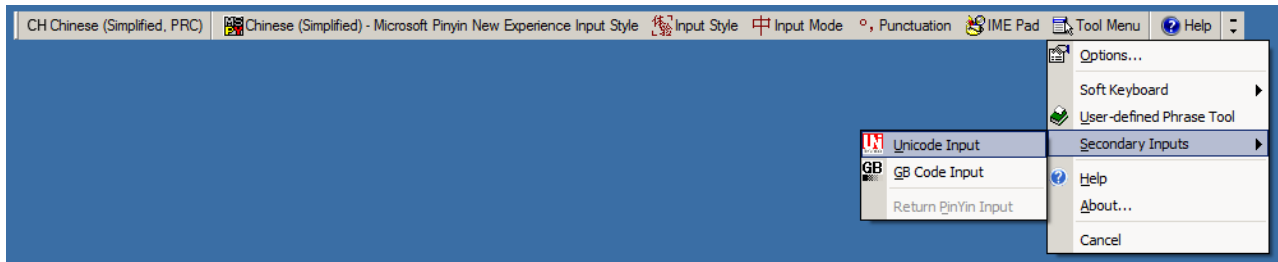

Figure D-2 Unicode/GBK Input on Windows 7

Selecting the Traditional Chinese Input Method on the Host

To select the Traditional Chinese input method:

Figure D-3 *Select Unicode input on Windows XP: Chinese (Traditional) - Unicode*

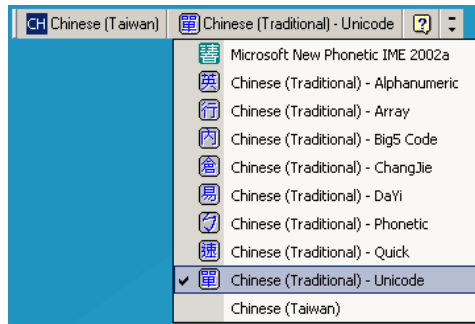

Figure D-4 *Unicode Input on Windows XP*

- Select Big5 input on Windows XP: **Chinese (Traditional) - Big5 Code**

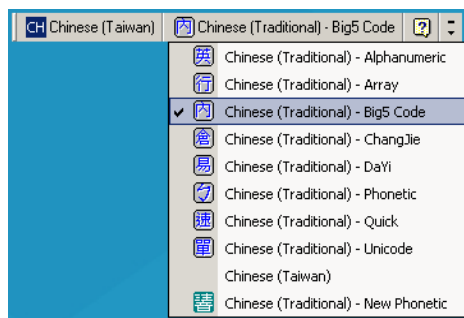

Figure D-5 *Big5 input on Windows XP*

- Select Unicode/Big5 input on Windows 7: **Chinese (Traditional) - New Quick**. This option support both Unicode and Big5 input.



Figure D-6 *Unicode/Big5 input on Windows 7*

APPENDIX E PROGRAMMING REFERENCE

Symbol Code Identifiers

Table E-1 *Symbol Code Characters*

Code Character	Code Type
A	UPC-A, UPC-E, UPC-E1, EAN-8, EAN-13
B	Code 39, Code 32
C	Codabar
D	Code 128, ISBT 128, ISBT 128 Concatenated
E	Code 93
F	Interleaved 2 of 5
G	Discrete 2 of 5, or Discrete 2 of 5 IATA
H	Code 11
J	MSI
K	GS1-128
L	Bookland EAN
M	Trioptic Code 39
N	Coupon Code
R	GS1 DataBar Family
S	Matrix 2 of 5
T	UCC Composite, TLC 39
U	Chinese 2 of 5

Table E-1 *Symbol Code Characters (Continued)*

Code Character	Code Type
V	Korean 3 of 5
X	ISSN EAN, PDF417, Macro PDF417, Micro PDF417
z	Aztec, Aztec Rune
P00	Data Matrix
P01	QR Code, MicroQR
P02	Maxicode
P03	US Postnet
P04	US Planet
P05	Japan Postal
P06	UK Postal
P08	Netherlands KIX Code
P09	Australia Post
P0A	USPS 4CB/One Code/Intelligent Mail
P0B	UPU FICS Postal
P0C	Mailmark
P0D	Grid Matrix, Grid Matrix Inverse, Grid Matrix Mirror
P0G	GS1 Data Matrix
P0H	Han Xin
P0Q	GS1 QR
P0X	Signature Capture

AIM Code Identifiers

Each AIM Code Identifier contains the three-character string **jcm** where:

- j = Flag Character (ASCII 93)
- c = Code Character (see [Table E-2](#))
- m = Modifier Character (see [Table E-3](#))

Table E-2 *Aim Code Characters*

Code Character	Code Type
A	Code 39, Code 39 Full ASCII, Code 32
C	Code 128, ISBT 128, ISBT 128 Concatenated, GS1-128, Coupon (Code 128 portion)
d	Data Matrix
d2	GS1 Data Matrix
E	UPC/EAN, Coupon (UPC portion)
e	GS1 DataBar Family
F	Codabar
G	Code 93
g	Grid Matrix, Grid Matrix Inverse, Grid Matrix Mirror
H	Code 11
h	Han Xin
I	Interleaved 2 of 5
L	PDF417, Macro PDF417, Micro PDF417
L2	TLC 39
M	MSI
Q	QR Code, MicroQR
Q3	GS1 QR
S	Discrete 2 of 5, IATA 2 of 5
U	Maxicode
z	Aztec, Aztec Rune
X	Bookland EAN, ISSN EAN, Trioptic Code 39, Chinese 2 of 5, Matrix 2 of 5, Korean 3 of 5, US Postnet, US Planet, UK Postal, Japan Postal, Australia Post, Netherlands KIX Code, USPS 4CB/One Code/Intelligent Mail, UPU FICS Postal, Signature Capture
X0	Mailmark

The modifier character is the sum of the applicable option values based on [Table E-3](#).

Table E-3 *Modifier Characters*

Code Type	Option Value	Option
Code 39	0	No check character or Full ASCII processing.
	1	Reader has checked one check character.
	3	Reader has checked and stripped check character.
	4	Reader has performed Full ASCII character conversion.
	5	Reader has performed Full ASCII character conversion and checked one check character.
	7	Reader has performed Full ASCII character conversion and checked and stripped check character.
	Example: A Full ASCII barcode with check character W, A+I+MI+DW , is transmitted as J A7AIMID where 7 = (3+4).	
Trioptic Code 39	0	No option specified at this time. Always transmit 0.
	Example: A Trioptic barcode 412356 is transmitted as J X0412356	
Code 128	0	Standard data packet, no Function code 1 in first symbol position.
	1	Function code 1 in first symbol character position.
	2	Function code 1 in second symbol character position.
	Example: A Code (EAN) 128 barcode with Function 1 character ^{FNC1} in the first position, AIMID is transmitted as J C1AIMID	
I 2 of 5	0	No check digit processing.
	1	Reader has validated check digit.
	3	Reader has validated and stripped check digit.
	Example: An I 2 of 5 barcode without check digit, 4123, is transmitted as J I04123	
Codabar	0	No check digit processing.
	1	Reader has checked check digit.
	3	Reader has stripped check digit before transmission.
	Example: A Codabar barcode without check digit, 4123, is transmitted as J F04123	
Code 93	0	No options specified at this time. Always transmit 0.
	Example: A Code 93 barcode 012345678905 is transmitted as J G0012345678905	
MSI	0	Check digits are sent.
	1	No check digit is sent.
	Example: An MSI barcode 4123, with a single check digit checked, is transmitted as J M14123	

Table E-3 *Modifier Characters (Continued)*

Code Type	Option Value	Option
D 2 of 5	0	No options specified at this time. Always transmit 0.
	Example: A D 2 of 5 barcode 4123, is transmitted as JS04123	
UPC/EAN	0	Standard data packet in full EAN format, i.e. 13 digits for UPC-A, UPC-E, and EAN-13 (not including supplemental data).
	1	Two digit supplemental data only.
	2	Five digit supplemental data only.
	3	Combined data packet comprising 13 digits from EAN-13, UPC-A or UPC-E symbol and 2 or 5 digits from supplemental symbol.
	4	EAN-8 data packet.
Example: A UPC-A barcode 012345678905 is transmitted as JE00012345678905		
Bookland EAN	0	No options specified at this time. Always transmit 0.
	Example: A Bookland EAN barcode 123456789X is transmitted as JX0123456789X	
ISSN EAN	0	No options specified at this time. Always transmit 0.
	Example: An ISSN EAN barcode 123456789X is transmitted as JX0123456789X	
Code 11	0	Single check digit
	1	Two check digits
	3	Check characters validated but not transmitted.
GS1 DataBar Family		No option specified at this time. Always transmit 0. GS1 DataBar-14 and GS1 DataBar Limited transmit with an Application Identifier "01". Note: In GS1-128 emulation mode, GS1 DataBar is transmitted using Code 128 rules (i.e., J C1).
	Example: A GS1 DataBar-14 barcode 0110012345678902 is transmitted as Je00110012345678902 .	
EAN.UCC Composites (GS1 DataBar, GS1-128, 2D portion of UPC composite)		Native mode transmission. Note: UPC portion of composite is transmitted using UPC rules.
	0	Standard data packet.
	1	Data packet containing the data following an encoded symbol separator character.
	2	Data packet containing the data following an escape mechanism character. The data packet does not support the ECI protocol.
	3	Data packet containing the data following an escape mechanism character. The data packet supports the ECI protocol.
		GS1-128 emulation Note: UPC portion of composite is transmitted using UPC rules.
1	Data packet is a GS1-128 symbol (i.e., data is preceded with J C1).	

Table E-3 *Modifier Characters (Continued)*

Code Type	Option Value	Option
PDF417, Micro PDF417	0	Reader set to conform to protocol defined in 1994 PDF417 symbology specifications. Note: When this option is transmitted, the receiver cannot reliably determine whether ECIs have been invoked or whether data byte 92 _{DEC} has been doubled in transmission.
	1	Reader set to follow the ECI protocol (Extended Channel Interpretation). All data characters 92 _{DEC} are doubled.
	2	Reader set for Basic Channel operation (no escape character transmission protocol). Data characters 92 _{DEC} are not doubled. Note: When decoders are set to this mode, unbuffered Macro symbols and symbols requiring the decoder to convey ECI escape sequences cannot be transmitted.
	3	The barcode contains a GS1-128 symbol, and the first codeword is 903-907, 912, 914, 915.
	4	The barcode contains a GS1-128 symbol, and the first codeword is in the range 908-909.
	5	The barcode contains a GS1-128 symbol, and the first codeword is in the range 910-911.
	Example: A PDF417 barcode ABCD, with no transmission protocol enabled, is transmitted as JL2ABCD .	
Data Matrix	0	ECC 000-140, not supported.
	1	ECC 200.
	2	ECC 200, FNC1 in first or fifth position.
	3	ECC 200, FNC1 in second or sixth position.
	4	ECC 200, ECI protocol implemented.
	5	ECC 200, FNC1 in first or fifth position, ECI protocol implemented.
	6	ECC 200, FNC1 in second or sixth position, ECI protocol implemented.
GS1 Data Matrix	2	ECC 200, FNC1 in first or fifth position.
MaxiCode	0	Symbol in Mode 4 or 5.
	1	Symbol in Mode 2 or 3.
	2	Symbol in Mode 4 or 5, ECI protocol implemented.
	3	Symbol in Mode 2 or 3, ECI protocol implemented in secondary message.

Table E-3 *Modifier Characters (Continued)*

Code Type	Option Value	Option
QR Code	0	Model 1 symbol.
	1	Model 2 / MicroQR symbol, ECI protocol not implemented.
	2	Model 2 symbol, ECI protocol implemented.
	3	Model 2 symbol, ECI protocol not implemented, FNC1 implied in first position.
	4	Model 2 symbol, ECI protocol implemented, FNC1 implied in first position.
	5	Model 2 symbol, ECI protocol not implemented, FNC1 implied in second position.
	6	Model 2 symbol, ECI protocol implemented, FNC1 implied in second position.
GS1 QR	3	Model 2 symbol, ECI protocol not implemented, FNC1 implied in first position.
Aztec	0	Aztec symbol.
	C	Aztec Rune symbol.
Han Xin	0	Generic data, no special features are set. The transmitted data does not follow the AIM ECI protocol.
	1	ECI protocol enabled. There is at least one ECI mode encoded. Transmitted data must follow the AIM ECI protocol.
Grid Matrix, Grid Matrix Inverse, Grid Matrix Mirror	0	No option specified at this time. Always transmit 0.
Mailmark	0	No option specified at this time. Always transmit 0.

APPENDIX F SAMPLE BAR CODES

Code 39



UPC/EAN

UPC-A, 100%



EAN-13, 100%



Code 128

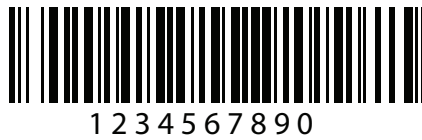

Interleaved 2 of 5



GS1 DataBar-14

✓ **NOTE** DataBar-14 must be enabled to read the barcode below (see [GS1 DataBar-14 on page 13-71](#)).



7612341562341

PDF417

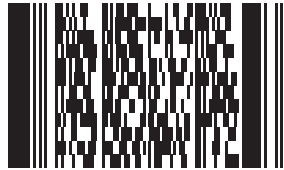

Data Matrix



Maxicode

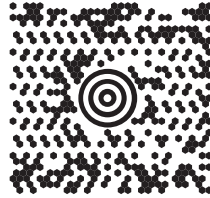

QR Code



US Postnet



UK Postal



APPENDIX G ALPHANUMERIC BAR CODES

Alphanumeric Bar Codes



Space



#



\$



%

Alphanumeric Keyboard (continued)



*



+



-



.



/



!

Alphanumeric Keyboard (continued)



“



&



{



(



)



:

Alphanumeric Keyboard (continued)



;



<



=



>



?



@

Alphanumeric Keyboard (continued)



[



\



]



^

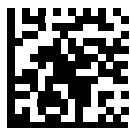

-



_

Alphanumeric Keyboard (continued)



NOTE Do not confuse the barcodes that follow with those on the numeric keypad.



0



1



2



3



4



5

Alphanumeric Keyboard (continued)



6



7



8



9

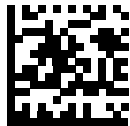

End of Message



Cancel

Alphanumeric Keyboard (continued)



A

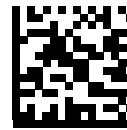

B



C



D



E



F

Alphanumeric Keyboard (continued)



G

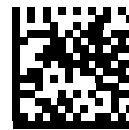

H



I



J



K



L

Alphanumeric Keyboard (continued)



M



N



O



P



Q



R

Alphanumeric Keyboard (continued)



S



T



U



V



W



X

Alphanumeric Keyboard (continued)



Y

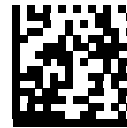

Z



a



b



c



d

Alphanumeric Keyboard (continued)



e



f



g



h



i



j

Alphanumeric Keyboard (continued)



k



l



m



n



o



p

Alphanumeric Keyboard (continued)



q



r

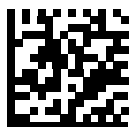

s



t



u



v

Alphanumeric Keyboard (continued)



w

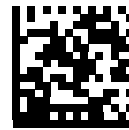

x



y

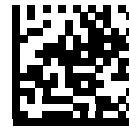

z



{



|

Alphanumeric Keyboard (continued)



}

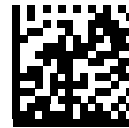

~

APPENDIX H NUMERIC BAR CODES

Numeric Bar Codes

For parameters requiring specific numeric values, scan the appropriately numbered barcode(s).

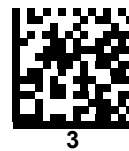
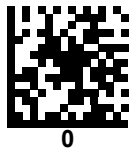

Numeric Bar Codes (continued)



5



6



7



8



9

Cancel

To correct an error or change a selection, scan the barcode below.



Cancel

APPENDIX I ASCII CHARACTER SETS

Table I-1 *ASCII Character Set*

ASCII Value	Full ASCII Code 39 Encode Char	Keystroke
1000	%U	CTRL 2
1001	\$A	CTRL A
1002	\$B	CTRL B
1003	\$C	CTRL C
1004	\$D	CTRL D
1005	\$E	CTRL E
1006	\$F	CTRL F
1007	\$G	CTRL G
1008	\$H	CTRL H/ BACKSPACE ¹
1009	\$I	CTRL I/ HORIZONTAL TAB ¹
1010	\$J	CTRL J
1011	\$K	CTRL K
1012	\$L	CTRL L
1013	\$M	CTRL M/ ENTER ¹
1014	\$N	CTRL N
1015	\$O	CTRL O

The keystroke in bold transmits only if you enabled Function Key Mapping. Otherwise, the unbold keystroke transmits.

Table I-1 ASCII Character Set (Continued)

ASCII Value	Full ASCII Code 39 Encode Char	Keystroke
1016	\$P	CTRL P
1017	\$Q	CTRL Q
1018	\$R	CTRL R
1019	\$S	CTRL S
1020	\$T	CTRL T
1021	\$U	CTRL U
1022	\$V	CTRL V
1023	\$W	CTRL W
1024	\$X	CTRL X
1025	\$Y	CTRL Y
1026	\$Z	CTRL Z
1027	%A	CTRL [
1028	%B	CTRL \
1029	%C	CTRL]
1030	%D	CTRL 6
1031	%E	CTRL -
1032	Space	Space
1033	/A	!
1034	/B	"
1035	/C	#
1036	/D	\$
1037	/E	%
1038	/F	&
1039	/G	'
1040	/H	(
1041	/I)
1042	/J	*
1043	/K	+

The keystroke in bold transmits only if you enabled Function Key Mapping. Otherwise, the unbold keystroke transmits.

Table I-1 ASCII Character Set (Continued)

ASCII Value	Full ASCII Code 39 Encode Char	Keystroke
1044	/L	,
1045	-	-
1046	.	.
1047	/o	/
1048	0	0
1049	1	1
1050	2	2
1051	3	3
1052	4	4
1053	5	5
1054	6	6
1055	7	7
1056	8	8
1057	9	9
1058	/Z	:
1059	%F	;
1060	%G	<
1061	%H	=
1062	%I	>
1063	%J	?
1064	%V	@
1065	A	A
1066	B	B
1067	C	C
1068	D	D
1069	E	E
1070	F	F
1071	G	G

The keystroke in bold transmits only if you enabled Function Key Mapping. Otherwise, the unbold keystroke transmits.

Table I-1 ASCII Character Set (Continued)

ASCII Value	Full ASCII Code 39 Encode Char	Keystroke
1072	H	H
1073	I	I
1074	J	J
1075	K	K
1076	L	L
1077	M	M
1078	N	N
1079	O	O
1080	P	P
1081	Q	Q
1082	R	R
1083	S	S
1084	T	T
1085	U	U
1086	V	V
1087	W	W
1088	X	X
1089	Y	Y
1090	Z	Z
1091	%K	[
1092	%L	\
1093	%M]
1094	%N	^
1095	%O	_
1096	%W	'
1097	+A	a
1098	+B	b
1099	+C	c

The keystroke in bold transmits only if you enabled Function Key Mapping. Otherwise, the unbold keystroke transmits.

Table I-1 ASCII Character Set (Continued)

ASCII Value	Full ASCII Code 39 Encode Char	Keystroke
1100	+D	d
1101	+E	e
1102	+F	f
1103	+G	g
1104	+H	h
1105	+I	i
1106	+J	j
1107	+K	k
1108	+L	l
1109	+M	m
1110	+N	n
1111	+O	o
1112	+P	p
1113	+Q	q
1114	+R	r
1115	+S	s
1116	+T	t
1117	+U	u
1118	+V	v
1119	+W	w
1120	+X	x
1121	+Y	y
1122	+Z	z
1123	%P	{
1124	%Q	
1125	%R	}
1126	%S	~
1127		Undefined

The keystroke in bold transmits only if you enabled Function Key Mapping. Otherwise, the unbold keystroke transmits.

Table I-2 *ALT Key Standard Default Tables*

ALT Keys	Keystroke
2050	ALT 2
2054	ALT 6
2064	ALT @
2065	ALT A
2066	ALT B
2067	ALT C
2068	ALT D
2069	ALT E
2070	ALT F
2071	ALT G
2072	ALT H
2073	ALT I
2074	ALT J
2075	ALT K
2076	ALT L
2077	ALT M
2078	ALT N
2079	ALT O
2080	ALT P
2081	ALT Q
2082	ALT R
2083	ALT S
2084	ALT T
2085	ALT U
2086	ALT V
2087	ALT W
2088	ALT X
2089	ALT Y
2090	ALT Z

Table I-2 ALT Key Standard Default Tables (Continued)

ALT Keys	Keystroke
2091	ALT [
2092	ALT \
2093	ALT]

Table I-3 USB GUI Key Character Set

GUI Key	Keystroke
3000	Right Control Key
3001	PA 1
3002	PA 2
3003	CMD 1
3004	CMD 2
3005	CMD 3
3006	CMD 4
3007	CMD 5
3008	CMD 6
3009	CMD 7
3010	CMD 8
3011	CMD 9
3012	CMD 10
3013	CMD 11
3014	CMD 12
3015	CMD 13
3016	CMD 14
3048	GUI 0
3049	GUI 1
3050	GUI 2
3051	GUI 3

Note: GUI Shift Keys - The Apple™ iMac keyboard has an apple key on either side of the space bar. Windows-based systems have a GUI key to the left of the left ALT key, and to the right of the right ALT key.

Table I-3 *USB GUI Key Character Set (Continued)*

GUI Key	Keystroke
3052	GUI 4
3053	GUI 5
3054	GUI 6
3055	GUI 7
3056	GUI 8
3057	GUI 9
3065	GUI A
3066	GUI B
3067	GUI C
3068	GUI D
3069	GUI E
3070	GUI F
3071	GUI G
3072	GUI H
3073	GUI I
3074	GUI J
3075	GUI K
3076	GUI L
3077	GUI M
3078	GUI N
3079	GUI O
3080	GUI P
3081	GUI Q
3082	GUI R
3083	GUI S
3084	GUI T
3085	GUI U

Note: GUI Shift Keys - The Apple™ iMac keyboard has an apple key on either side of the space bar. Windows-based systems have a GUI key to the left of the left ALT key, and to the right of the right ALT key.

Table I-3 *USB GUI Key Character Set (Continued)*

GUI Key	Keystroke
3086	GUI V
3087	GUI W
3088	GUI X
3089	GUI Y
3090	GUI Z

Note: GUI Shift Keys - The Apple™ iMac keyboard has an apple key on either side of the space bar. Windows-based systems have a GUI key to the left of the left ALT key, and to the right of the right ALT key.

Table I-4 *PF Key Standard Default Table*

PF Keys	Keystroke
4001	PF 1
4002	PF 2
4003	PF 3
4004	PF 4
4005	PF 5
4006	PF 6
4007	PF 7
4008	PF 8
4009	PF 9
4010	PF 10
4011	PF 11
4012	PF 12
4013	PF 13
4014	PF 14
4015	PF 15
4016	PF 16

Table I-5 *F key Standard Default Table*

F Keys	Keystroke
5001	F 1
5002	F 2
5003	F 3
5004	F 4
5005	F 5
5006	F 6
5007	F 7
5008	F 8
5009	F 9
5010	F 10
5011	F 11
5012	F 12
5013	F 13
5014	F 14
5015	F 15
5016	F 16
5017	F 17
5018	F 18
5019	F 19
5020	F 20
5021	F 21
5022	F 22
5023	F 23
5024	F 24

Table I-6 *Numeric Key Standard Default Table*

Numeric Keypad	Keystroke
6042	*
6043	+
6044	Undefined
6045	-
6046	.
6047	/
6048	0
6049	1
6050	2
6051	3
6052	4
6053	5
6054	6
6055	7
6056	8
6057	9
6058	Enter
6059	Num Lock

Table I-7 *Extended Keypad Standard Default Table*

Extended Keypad	Keystroke
7001	Break
7002	Delete
7003	Pg Up
7004	End
7005	Pg Dn
7006	Pause
7007	Scroll Lock
7008	Backspace
7009	Tab
7010	Print Screen
7011	Insert
7012	Home
7013	Enter
7014	Escape
7015	Up Arrow
7016	Dn Arrow
7017	Left Arrow
7018	Right Arrow

APPENDIX J COMMUNICATION PROTOCOL FUNCTIONALITY

Functionality Supported via Communication (Cable) Interface

[Table J-1](#) lists supported scanner functionality by communication protocol.

Table J-1 Communication Interface Functionality

Communication Interfaces	Functionality		
	Data Transmission	Remote Management	Image and Video Transmission
USB			
HID Keyboard Emulation	Supported	Not Available	Not Available
CDC COM Port Emulation	Supported	Not Available	Not Available
SSI over CDC COM Port Emulation	Supported	Supported	Supported
IBM Table-top USB	Supported	Supported	Not Available
IBM Hand-held USB	Supported	Supported	Not Available
USB OPOS Hand-held	Supported	Supported	Not Available
Symbol Native API (SNAPI) without Imaging Interface	Supported	Supported	Not Available
Symbol Native API (SNAPI) with Imaging Interface	Supported	Supported	Supported
Toshiba TEC	Not Available	Not Available	Not Available
RS-232			
Standard RS-232	Supported	Not Available	Not Available
ICL RS-232	Supported	Not Available	Not Available
Fujitsu RS-232	Supported	Not Available	Not Available
Wincor-Nixdorf RS-232 Mode A	Supported	Not Available	Not Available

Table J-1 *Communication Interface Functionality (Continued)*

Communication Interfaces	Functionality		
	Data Transmission	Remote Management	Image and Video Transmission
Wincor-Nixdorf RS-232 Mode B	Supported	Not Available	Not Available
Olivetti ORS4500	Supported	Not Available	Not Available
Omron	Supported	Not Available	Not Available
CUTE	Supported	Not Available	Not Available
OPOS/JPOS	Supported	Not Available	Not Available
SSI	Supported	Supported	Supported
IBM 4690			
Hand-held Scanner Emulation (Port 9B)	Supported	Not Available	Not Available
Table-top Scanner Emulation (Port 17)	Supported	Supported	Not Available
Non-IBM Scanner Emulation (Port 5B)	Supported	Supported	Not Available
Keyboard Wedge			
IBM PC/AT & IBM PC Compatibles	Supported	Not Available	Not Available
IBM AT Notebook	Supported	Not Available	Not Available

APPENDIX K SIGNATURE CAPTURE CODE

Introduction

CapCode, a signature capture code, is a special pattern that encloses a signature area on a document and allows a scanner to capture a signature.

There are several accepted patterns that allow automatic identification of different signatures on the same form. For example, on the federal tax return 1040 form there are three signature areas, one each for two joint filers, and one for a professional preparer. By using different patterns, a program can correctly identify all three, so they can be captured in any sequence and still be identified correctly.

Code Structure

Signature Capture Area

A CapCode is printed as two identical patterns on either side of a signature capture box, as shown in [Figure K-1](#). Each pattern extends the full height of the signature capture box.

The box is optional, so you can omit it, replace it with a single baseline, or print a baseline with an "X" on top of it towards the left, as is customarily done in the US to indicate a request for signature. However, if an "X" or other markings are added in the signature box area, these are captured with the signature.



Figure K-1 CapCode

CapCode Pattern Structure

A CapCode pattern structure consists of a start pattern followed by a separator space, a signature capture box, a second separator space, and then a stop pattern. Assuming that X is the dimension of the thinnest element, the start and stop patterns each contains 9X total width in 4 bars and 3 spaces. A 7X quiet zone is required to the left and to the right of the CapCode pattern.

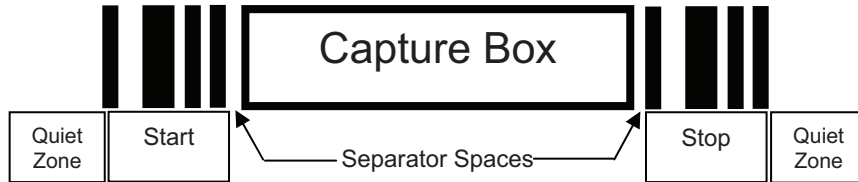

Figure K-2 CapCode Structure

The separator spaces on either side of the signature capture box can be between 1X and 3X wide.

Start / Stop Patterns

Table K-1 lists the accepted start / stop patterns. The bar and space widths are expressed as multiples of X. You must use the same pattern on either side of a signature capture box. The type value is reported with the captured signature to indicate the purpose of the signature captured.

Table K-1 Start / Stop Pattern Definitions

Bar/Space Patterns							Type
B	S	B	S	B	S	B	
1	1	2	2	1	1	1	2
1	2	2	1	1	1	1	5
2	1	1	2	1	1	1	7
2	2	1	1	1	1	1	8
3	1	1	1	1	1	1	9

[Table K-2](#) lists selectable parameters used to generate the image of the captured signature.

Table K-2 *User Defined CapCode Parameters*

Parameter	Defined
Width	Number of pixels
Height	Number of pixels
Format	JPEG, BMP, TIFF
JPEG quality	1 (most compression) to 100 (best quality)
Bits Per Pixel (not applicable to JPEG format)	1 (2 levels)
	4 (16 levels)
	8 (256 levels)

BMP format does not use compression, JPEG and TIFF formats do.

Dimensions

The size of the signature capture box is determined by the height and separation of the start and stop patterns. The line width of the signature capture box is insignificant.

The thinnest element width, referred to here as X, is nominally 10 mils (1 mil = 0.0254 mm). Select this as an exact multiple of the pixel pitch of the printer used. For example, when using a 203 DPI (dots-per-inch) printer and printing 2 dots per module, the resulting X dimension is 9.85 mils.

Data Format

The decoder output is formatted according to [Table K-3](#). Zebra decoders allow different user options to output or inhibit barcode type. Selecting "Symbol ID" as the barcode type for output identifies the CapCode with letter "i".

Table K-3 *Data Format*

File Format (1 byte)	Type (1 byte)	Image Size (4 bytes, BIG Endian)	Image Data
JPEG - 1 BMP - 3 TIFF - 4	See Table K-1 , last column		(Same bytes as in a data file)

Additional Capabilities

Regardless of how the signature is captured, the output signature image is de-skewed and right-side up.

A scanner that captures signatures automatically determines whether it is scanning a signature or a barcode. You can disable the signature capturing capability in a decoder.

Signature Boxes

Figure K-3 illustrates the five acceptable signature boxes:

Type 2:



Type 5:



Type 7:



Type 8:



Type 9:



Figure K-3 *Acceptable Signature Boxes*

APPENDIX L NON-PARAMETER ATTRIBUTES

Introduction

This appendix defines non-parameter attributes.

Attributes

Model Number

Attribute #533

Model number of the scanner. This electronic output matches the printout on the physical device label, for example **LI2208-SR00006ZZWW**.

Type	S
Size (Bytes)	18
User Mode Access	R
Values	Variable

Serial Number

Attribute #534

Unique serial number assigned in the manufacturing facility. This electronic output matches the printout on the physical device label, for example **M1J26F45V**.

Type	S
Size (Bytes)	16
User Mode Access	R
Values	Variable

Date of Manufacture

Attribute #535

Date of device manufacture assigned in the manufacturing facility. This electronic output matches the printout on the physical device label, for example **30APR14** (which reads the 30th of April 2014).

Type	S
Size (Bytes)	7
User Mode Access	R
Values	Variable

Date of First Programming

Attribute #614

Date of first electronic programming represents the first time settings were electronically loaded to the scanner either by 123Scan or via SMS, for example **18MAY14** (which reads the 18th of May 2014).

Type	S
Size (Bytes)	7
User Mode Access	R
Values	Variable

Configuration Filename

Attribute #616

The name assigned to the configuration settings loaded electronically to the device either by 123Scan or via SMS.



NOTE Scanning the **Set Defaults** barcode automatically changes the configuration filename to *factory defaults*.

To indicate the configuration settings loaded to the device were changed, the configuration filename changes to *Modified* upon scanning any parameter barcode.

Type	S
Size (Bytes)	17
User Mode Access	RW
Values	Variable

Beeper/LED**Attribute #6000**

Activates the beeper and/or LED.

Type	X
Size (Bytes)	N/A
User Mode Access	W

Values:

Beep / LED Action	Value
1 high short beep	0
2 high short beeps	1
3 high short beeps	2
4 high short beeps	3
5 high short beeps	4
1 low short beep	5
2 low short beeps	6
3 low short beeps	7
4 low short beeps	8
5 low short beeps	9
1 high long beep	10
2 high long beeps	11
3 high long beeps	12
4 high long beeps	13
5 high long beeps	14
1 low long beep	15
2 low long beeps	16
3 low long beeps	17
4 low long beeps	18
5 low long beeps	19
Fast warble beep	20
Slow warble beep	21
High-low beep	22
Low-high beep	23
High-low-high beep	24
Low-high-low beep	25
High-high-low-low beep	26
Green LED off	42
Green LED on	43
Red LED on	47
Red LED off	48

Parameter Defaults

Attribute #6001

This attribute restores all parameters to their factory defaults.

Type	X
Size (Bytes)	N/A
User Mode Access	W
Values	0 = Restore Defaults 1 = Restore Factory Defaults 2 = Write Custom Defaults

Beep on Next Bootup

Attribute #6003

This attribute configures (enables or disables) beep on next boot up of scanner.

Type	X
Size (Bytes)	N/A
User Mode Access	W
Values	0 = Disable beep on next bootup 1 = Enable beep on next bootup

Reboot

Attribute #6004

This attribute initiates a device reboot.

Type	X
Size (Bytes)	N/A
User Mode Access	W
Values	N/A

Host Trigger Session

Attribute #6005

This attribute triggers a decode session similar to manually depressing the scanner trigger button.

Type	X
Size (Bytes)	N/A
User Mode Access	W
Values	1 = Start Host Trigger Session 0 = Stop Host Trigger Session

Firmware Version

Attribute #20004

The scanner's operating system version. For example, **NBRFMAAC** or **PAAAABS00-007-R03D0**.

Type	S
Size (Bytes)	Variable
User Mode Access	R
Values	Variable

Scankit Version

Attribute #20008

Identifies the 1D decode algorithms resident on the device, for example **SKIT4.33T02**.

Type	S
Size (Bytes)	Variable
User Mode Access	R
Values	Variable

ImageKit Version

Attribute #20013

Identifies the 2D decode algorithms resident on the device, for example **IMGKIT_7.01T08.31**

Type	S
Size (Bytes)	Variable
User Mode Access	R
Values	Variable

INDEX

Numerics

123Scan	2-1
2D bar codes	
aztec	13-87
aztec inverse	13-88
code 128 emulation	13-81
data matrix	13-82
data matrix inverse	13-83
grid matrix	13-90
grid matrix inverse	13-91
grid matrix mirrored	13-92
han xin	13-89
han xin inverse	13-89
linked QR mode	13-86
maxicode	13-84
microPDF417	13-80
microQR	13-85
PDF417	13-80
QR code	13-84

A

accessories	1-14, 1-18
interface cable	1-14, 1-18
power supply	1-14, 1-18
ADF	
invalid rule	4-5
transmit error	4-5
advanced data formatting	4-5
aiming options	
hand-held decode aiming pattern	6-25
snapshot aiming pattern	7-9
snapshot mode timeout	7-8
video view finder	7-24
aiming pattern	3-12, 3-13, 7-9
enabling	6-25

orientation	3-12
ASCII values	
keyboard wedge	12-11
RS-232	10-22
attributes	
non-parameter	L-1
attributes, non-parameter	
beep on next bootup	L-4
configuration filename	L-2
date of first programming	L-2
date of manufacture	L-2
firmware version	L-5
host trigger session	L-4
model number	L-1
parameter defaults	L-4
reboot	L-4
scankit version	L-5
serial number	L-1
autoexposure	7-5
auto-reconnect	5-26, 5-36, 5-40

B

bar code defaults	
radio communication	5-2
USB	8-4
bar codes	
Australia post	13-100
Australia post format	13-101
AutoConfig (scanner cloning through cradle)	5-43
autoexposure	7-5
auto-reconnect in Bluetooth keyboard emulation (HID peripheral) mode	5-30
auto-reconnect interval	5-26
aztec	13-87
aztec inverse	13-88
batch mode	5-45, 5-46

Index - 2 DS36X8 Digital Scanner Product Reference Guide

- beep after good decode 6-6
- beep on insertion 5-34
- beeper duration 6-11
- beeper tone 6-10
- beeper volume 6-9
- bits per pixel 7-19, 7-22
- Bluetooth friendly name 5-11
- Bluetooth technology support 5-20
- bookland EAN 13-11
- bookland ISBN 13-23
- cancel H-2
- Chinese 2 of 5 13-65
- codabar 13-52
- codabar CLSI editing 13-55
- codabar lengths 13-53
- codabar NOTIS editing 13-55
- codabar security level 13-56
- codabar start and stop characters 13-58
- code 11 13-42
- code 11 check digit verification 13-44
- code 11 lengths 13-43
- code 128 13-26
- code 128 emulation 13-81
- code 128 lengths 13-27
- code 128 reduced quiet zone 13-33
- code 128 security level 13-32
- code 32 prefix 13-35
- code 39 13-34
- code 39 check digit verification 13-37
- code 39 full ASCII 13-38
- code 39 lengths 13-36
- code 39 reduced quiet zone 13-40
- code 39 security level 13-39
- code 39 transmit check digit 13-37
- code 93 13-40
- code 93 lengths 13-41
- composite beep mode 13-79
- composite CC-A/B 13-75
- composite CC-C 13-75
- composite inverse 13-77
- composite TLC-39 13-76
- continuous bar code read 6-28
- convert code 39 to code 32 13-35
- convert GS1 databar to UPC/EAN 13-72
- convert UPC-E to UPC-A 13-22
- convert UPC-E1 to UPC-A 13-22
- country code page defaults C-1
- country code pages C-5
- country codes B-2
- crop to address 7-11
- data matrix 13-82
- data matrix inverse 13-83
- decode pager motor 6-13
- decode pager motor duration 6-13
- decode session timeout 6-30
- digimarc 15-2
- digimarc digital watermarks 15-2
- disable all code types 13-8
- discoverable mode 5-12
- discrete 2 of 5 13-50
- discrete 2 of 5 lengths 13-51
- DPM 6-56
 - illumination control 6-57
 - rough shiny surface decoding 6-58
 - ultra high density decoding 6-59
- EAN zero extend 13-23
- EAN-13/JAN-13 13-11
- EAN-8/JAN-8 13-10
- enable all code types 13-8
- enter 6-41
- event reporting
 - boot up event 9-24
 - decode event 9-23
 - parameter event 9-24
- fixed exposure 7-6
- flush macro buffer/abort macro PDF entry 13-109
- FN1 substitution values 6-45
- gain and exposure priority for snapshot mode 7-7
- grid matrix 13-90
- grid matrix inverse 13-91
- grid matrix mirrored 13-92
- GS1 databar bar codes 13-71
- GS1 databar expanded 13-72
- GS1 databar limited 13-71
- GS1 databar limited margin check 13-74
- GS1 databar security level 13-73
- GS1 databar-14 13-71
- GS1-128 13-29
- GS1-128 emulation mode 13-79
- han xin 13-89
- han xin inverse 13-89
- hand-held decode aiming pattern 6-25
- hands-free mode 6-23
- I 2 of 5 check digit verification 13-47
- I 2 of 5 convert to EAN-13 13-48
- I 2 of 5 reduced quiet zone 13-50
- I 2 of 5 security level 13-49
- I 2 of 5 transmit check digit 13-48
- IBM 468X/469X
 - bar code configuration directive 11-7
 - beep directive 11-6
 - convert unknown to code 39 11-6
 - default parameters 11-4
 - port address 11-5
- IDC
 - aspect 14-9
 - bits per pixel 14-11
 - border type 14-17

- captured image brighten 14-15
- captured image sharpen 14-16
- delay time 14-18
- file format selector 14-10
- find box outline 14-12
- height 14-8
- JPEG quality 14-12
- maximum rotation 14-19
- maximum text length 14-14
- minimum text length 14-13
- operating mode 14-5
- symbology 14-6
- width 14-8
- X coordinate 14-7
- Y coordinate 14-7
- zoom limit 14-18
- ignore code 128 fnc4 13-33
- illumination 6-37, 7-5
- image brightness (target white) 7-14
- image cropping 7-10
- image enhancement 7-16
- image file format 7-17, 7-21
- image resolution 7-13
- image rotation 7-18
- intercharacter gap size 13-108
- interleaved 2 of 5 13-45
 - convert to EAN-13 13-48, 13-49
- interleaved 2 of 5 lengths 13-46
- inverse 1D 13-70
- ISBT 128 13-29
- ISBT concatenation 13-30, 13-31
- ISBT concatenation redundancy 13-31
- ISSN EAN 13-25
- Japan postal 13-99
- JPEG image options 7-14
- JPEG quality and size 7-15
- JPEG target file size 7-15
- keyboard wedge
 - alternate numeric keypad emulation 12-7
 - caps lock override 12-8
 - default table 12-4
 - host types 12-5
 - ignore unknown characters 12-5
 - intra-keystroke delay 12-6
 - keystroke delay 12-6
 - quick keypad emulation 12-7
 - simulated caps lock 12-8
- Korean 3 of 5 13-69
- linked QR mode 13-86
- lock override 5-37
- low power mode 6-15, 6-20
- matrix 2 of 5 13-66
- matrix 2 of 5 check digit 13-68
- matrix 2 of 5 lengths 13-67
- maxicode 13-84
- microPDF417 13-80
- microQR 13-85
- mobile phone/display mode 6-33
- motion tolerance 6-37, 6-38
- MSI 13-60
 - reduced quiet zone 13-64
- MSI check digit algorithm 13-64
- MSI check digits 13-62
- MSI lengths 13-61
- MSI transmit check digit 13-63
- Netherlands KIX code 13-102
- number of retry attempts 5-32
- numeric bar codes H-2
- OCR
 - check digit 17-27
 - check digit multiplier 17-28
 - check digit validation 17-29
 - default table 17-1
 - inverse OCR 17-34
 - lines 17-14
 - maximum characters 17-15
 - MICR E13B 17-11
 - minimum character 17-14
 - OCR-A 17-3
 - OCR-A variant 17-4
 - OCR-B 17-6
 - OCR-B variant 17-7
 - orientation 17-12
 - parameters 17-3
 - quiet zone 17-16
 - redundancy 17-35
 - subset 17-15
 - template 17-17
 - US currency serial number 17-12
- outdoor picklist mode 6-27
- pager motor 6-13
- parameter broadcast 5-36
- parameter scanning 6-6
- PDF prioritization 6-34
- PDF prioritization timeout 6-35
- PDF417 13-80
- picklist mode 6-26
- pid type 6-48
- pid value 6-49
- postal 13-97
- prefix/suffix values 6-43
- presentation mode field of view 6-36
- QR code 13-84
- quiet zone level 13-107
- radio output power 5-36
- reconnect attempt beep 5-27
- reconnect attempt interval 5-28
- redundancy level 13-104

report version	13-108	trigger mode	6-22, 6-23
RS-232		trigger modes	6-19
baud rate	10-10	triggered timeout, same symbol	6-32
beep on bel	6-7	trioptic code 39	13-34
check receive errors	10-13	UCC coupon extended code	13-24
data bits	10-12	UID	6-50
default table	10-4	UK postal	13-98
hardware handshaking	10-13, 10-14	unicode output control	D-2
host serial response time-out	10-17	unique bar code reporting	6-29
host types	10-7	unpair	5-38, 5-39
intercharacter delay	10-18	unsolicited heartbeat interval	6-47
parity	10-11	UPC composite mode	13-78
RTS line state	10-18	UPC reduced quiet zone	13-17
software handshaking	10-15, 10-16	UPC/EAN	
stop bit select	6-7	coupon code	13-24
stop bits	10-12	UPC/EAN supplemental AIM ID format	13-16
samples	F-1	UPC/EAN supplemental redundancy	13-15
scan data options	6-44	UPC/EAN supplementals	13-12
scanner to cradle support	5-35	UPC-A	13-9
security level	13-106	UPC-A check digit	13-17
set defaults	6-5	UPC-A preamble	13-19
signature capture	7-20	UPC-E	13-9
signature capture height	7-23	UPC-E check digit	13-18
signature capture JPEG quality	7-24	UPC-E preamble	13-20
signature capture width	7-23	UPC-E1	13-10
silence operational mode changes	7-9	UPC-E1 check digit	13-18
sleep between reconnect attempts	5-31	UPC-E1 preamble	13-21
snapshot aiming pattern	7-9	UPU FICS postal	13-103
snapshot mode timeout	7-8	US planet	13-97
SSI		US postnet	13-97
baud rate	9-12	USB	
check parity	9-14	caps lock override	8-9
data packet format	9-17	convert case	8-14
host character timeout	9-20	country keyboard types (country codes)	B-2
host RTS line state	9-17	device type	8-5, 8-6, 8-7
host serial response time-out	9-19	emulate keypad	8-11
interpacket delay	9-22	emulate keypad with leading zero	8-11
multipacket option	9-21	fast HID	8-19
parity	9-13	function key mapping	8-13
selecting	9-11	IBM specification version	8-19
software handshaking	9-16	keyboard FN 1 sub	8-12
stop bit select	9-15	keystroke delay	8-9
suppress power up beeps	6-12	optional parameters	8-16
symbolologies		polling interval	8-17, 8-18
default table	13-2	quick emulation	8-12
time delay to low power mode	6-16, 6-17, 6-18	simulated caps lock	8-13
timeout between decodes, different symbols	6-31	SNAPI handshaking	8-8
timeout between decodes, same symbol	6-31	static CDC	8-15
transmit code 11 check digits	13-45	unknown characters	8-10
transmit code ID character	6-42	USPS 4CB/One Code/Intelligent Mail	13-102
transmit matrix 2 of 5 check digit	13-68	variable PIN code	5-53
transmit no read message	6-46	video image size	7-25
transmit UK postal check digit	13-99	video view finder	7-24
transmit US postal check digit	13-98	wi-fi friendly channel exclusion	5-14

- wi-fi friendly mode 5-13
 - barcodes
 - IBM
 - specification version 11-7
 - batch mode stored data 5-45
 - battery
 - charging 1-9
 - inserting 1-8
 - removing 1-8
 - beeper definitions
 - ADF programming 3-3
 - host specific 3-4
 - pairing 5-5
 - parameter programming 3-3
 - scanning 3-2
 - standard 3-2
 - wireless 5-5
 - Bluetooth
 - encryption 5-54
 - HID 5-10, 5-20, 5-30
 - pin code 5-52
 - profiles 5-5
 - secure simple pairing IO capability 5-54
 - serial port profile 5-10
 - set friendly name 5-11
 - SPP 5-26
 - bluetooth 1-3, 1-11
 - bullets xxxiii
- C**
- cable configurations xxviii
 - cables
 - installing 1-6
 - interface 1-14, 1-18
 - signal descriptions 4-12
 - central 5-10
 - central serial port profile 5-26, 5-36
 - character sets
 - keyboard wedge 12-11
 - RS-232 10-22
 - charging 1-9
 - Chinese 2 of 5 bar codes 13-65
 - CJK D-1
 - codabar bar codes 13-52
 - CLSI editing 13-55
 - lengths 13-53
 - NOTIS editing 13-55
 - security level 13-56
 - start and stop characters 13-58
 - code 11 bar codes 13-42
 - check digit verification 13-44
 - lengths 13-43
 - transmit check digit 13-45
 - code 128 bar codes 13-26
 - GS1-128 13-29
 - ignore fnc4 13-33
 - ISBT 128 13-29
 - ISBT concatenation 13-30, 13-31
 - ISBT concatenation redundancy 13-31
 - lengths 13-27
 - reduced quiet zone 13-33
 - security level 13-32
 - code 128 emulation bar codes 13-81
 - code 39 bar codes 13-34
 - check digit verification 13-37
 - code 32 prefix 13-35
 - code 39 13-34
 - code 39 security Level 13-39
 - convert code 39 to code 32 13-35
 - full ASCII 13-38
 - lengths 13-36
 - reduced quiet zone 13-40
 - transmit check digit 13-37
 - trioptic 13-34
 - code 93 bar codes 13-40
 - lengths 13-41
 - code ID character 6-42
 - code identifiers
 - AIM code IDs E-3
 - modifier characters E-4
 - Symbol E-1
 - communication protocol J-1
 - composite bar codes
 - beep mode 13-79
 - composite CC-A/B 13-75
 - composite CC-C 13-75
 - composite inverse 13-77
 - composite TLC-39 13-76
 - GS1-128 emulation mode 13-79
 - UPC composite mode 13-78
 - configurations xxiii
 - product line xxviii
 - configuring scanner 1-11
 - connecting
 - IBM 468X/469X interface 11-2
 - keyboard wedge interface 12-2
 - lost connection 1-11
 - power 1-18
 - RS-232 interface 10-2
 - conventions
 - notational xxxiii
 - country code page defaults C-1
 - country code pages C-5
 - country codes B-2
 - cradle
 - connecting 1-6
 - inserting scanner 1-10

mounting 1-7
 supply power 1-7
 cradle configurations xxviii
 cropping 7-10, 7-11

D

data matrix bar codes 13-82
 default parameters
 IBM 468X/469X 11-4
 IDC 14-4
 keyboard wedge 12-4
 OCR 17-1
 radio communication 5-2
 RS-232 10-4
 setting 6-5
 SSI 9-10
 symbolologies 13-2
 USB 8-4
 digimarc 15-1
 digital watermarks bar codes 15-2
 digimarc digital watermarks 15-2
 digital scanner
 parts 1-3, 1-15
 discrete 2 of 5 bar codes 13-50
 lengths 13-51

E

encryption 5-54
 error indications
 ADF 4-5
 format 4-6
 input 4-5
 miscellaneous scanner options 5-1
 unknown characters 8-10
 exposure options
 autoexposure 7-5
 fixed exposure 7-6
 gain and exposure priority for snapshot mode 7-7
 illumination 6-37, 7-5
 presentation mode field of view 6-36

F

fixed exposure 7-6

G

gain and exposure priority for snapshot mode 7-7
 gooseneck Intellistand 3-11
 GS1 databar 13-71
 GS1 databar bar codes
 convert GS1 databar to UPC/EAN 13-72

GS1 databar expanded 13-72
 GS1 databar limited 13-71
 GS1 databar limited margin check 13-74
 GS1 databar-14 13-71
 security level 13-73

H

HID Profile 5-10
 host types
 keyboard wedge 12-5
 RS-232 10-7
 USB 8-5, 8-6, 8-7

I

IBM 468X/469X
 connection 11-2
 default parameters 11-4
 parameters 11-5
 IDC 14-1
 bar code acceptance test 14-2
 capture region 14-2
 data transmission 14-3
 demonstrations 14-21
 image post processing 14-3
 operating mode 14-5
 quick start 14-20
 quick start form 14-22
 sample setup 14-20
 support 14-3
 illumination 6-37, 7-5
 image brightness (target white) 7-14
 image cropping 7-10, 7-11
 image enhancement 7-16
 image options
 bits per pixel 7-19
 cropping 7-10, 7-11
 file formats 7-17, 7-21
 image brightness (target white) 7-14
 image enhancement 7-16
 image resolution 7-13
 image rotation 7-18
 JPEG image options 7-14
 JPEG size/quality 7-15
 JPEG target file size 7-15
 image resolution 7-13
 indicators
 ADF programming 3-8
 image capture 3-7
 macro pdf 3-8
 maintenance 3-8
 parameter programming 3-7
 standard use 3-7

inserting battery	1-8
interleaved 2 of 5 bar codes	13-45
check digit verification	13-47
convert to EAN-13	13-48
lengths	13-46
reduced quiet zone	13-50
security level	13-49
transmit check digit	13-48

J

JPEG image options	7-14
size/quality	7-15
JPEG target file size	7-15

K

keyboard types (country codes)	
Albanian	B-2
Arabic (101)	B-2
Arabic (102)	B-3
Arabic (102) Azerty	B-3
Azeri (Cyrillic)	B-3
Azeri (Latin)	B-3
Belarusian	B-3
Bosnian (Cyrillic)	B-3
Bosnian (Latin)	B-3, B-4
Bulgarian (Latin)	B-4
Bulgarian Cyrillic (Typewriter)	B-4
Canadian French (Legacy)	B-4
Canadian French Win7	B-4
Canadian Multilingual Standard	B-4
Chinese (ASCII)	B-4
Croatian	B-5
Czech	B-5
Czech (Programmer)	B-5
Czech (QWERTY)	B-5
Danish	B-6
Dutch (Netherlands)	B-6
Estonian	B-6
Faeroese	B-6
Finnish	B-6
French (Canada) 2000/XP	B-7
French (Canada) 95/98	B-7
French (France)	B-6
French International	B-7
Galician	B-7
German	B-7
Greek	B-8
Greek (220) Latin	B-8
Greek (319) Latin	B-8
Greek 220	B-8
Greek 319	B-8
Greek Latin	B-7

Greek Polytonic	B-8
Hebrew Israel	B-9
Hungarian	B-9
Hungarian_101KEY	B-9
Irish	B-9
Islandic	B-9
Italian	B-9
Italian (142)	B-10
Japanese (ASCII)	B-10
Kazakh	B-10
Korean (ASCII)	B-10, B-11
Kyrgyz	B-11
Latin American	B-11
Latvian	B-11
Latvian (QWERTY)	B-11
Lithuanian	B-11
Lithuanian (IBM)	B-12
Macedonian (FYROM)	B-12
Maltese_47KEY	B-12
Mongolian	B-12
Norwegian	B-12
Polish (214)	B-12
Polish (Programmer)	B-13
Portuguese (Brazil)	B-13
Portuguese (Brazilian ABNT)	B-13
Portuguese (Brazilian ABNT2)	B-13
Portuguese (Portugal)	B-13
Romanian	B-13
Romanian (Legacy)	B-14
Romanian (Programmer)	B-14
Romanian (Standard)	B-14
Russian	B-14
Russian (Typewriter)	B-14
Serbian (Cyrillic)	B-15
Serbian (Latin)	B-14
Slovak	B-15
Slovak (QWERTY)	B-15
Slovenian	B-15
Spanish	B-15
Spanish (Variation)	B-15
Swedish	B-16
Swiss French	B-16
Swiss German	B-16
Tatar	B-16
Thai (Kedmanee)	B-16
Turkish F	B-16
Turkish Q	B-17
UK English	B-17
Ukrainian	B-17
US Dvorak	B-17
US Dvorak Left	B-17
US Dvorak Right	B-17
US English	B-2
US International	B-18

Uzbek	B-18
Vietnamese	B-18
keyboard wedge	
connection	12-2
default parameters	12-4
parameters	12-5
Korean 3 of 5 bar codes	13-69

L

lock override	5-37
locked pairing mode	5-37, 5-40
low power mode	5-26

M

macro PDF	13-109
flush buffer/abort PDF entry	13-109
maintenance	4-1
digital scanner	4-2
matrix 2 of 5 bar codes	13-66
check digit	13-68
lengths	13-67
transmit check digit	13-68
maxicode bar codes	13-84
microPDF417 bar codes	13-80
mounting	
cradle	1-7
MSI bar codes	13-60
check digit algorithm	13-64
check digits	13-62
lengths	13-61
reduced quiet zone	13-64
transmit check digit	13-63
multipoint-to-point communication	5-35

N

non-parameter attributes	L-1
beep on next bootup	L-4
configuration filename	L-2
date of first programming	L-2
date of manufacture	L-2
firmware version	L-5
host trigger session	L-4
model number	L-1
parameter defaults	L-4
reboot	L-4
scankit version	L-5
serial number	L-1
notational conventions	xxxiii
number of retry attempts	5-32

O

OCR	
default parameters	17-1
parameters	17-3
out of range indicator	5-34

P

pairing	1-11
address	5-26
bar code	5-5
bar code format	5-40
central/peripheral setup	5-10
connection maintenance interval	5-40
lock override	5-37
methods	5-38
modes	5-3, 5-36, A-2
multipoint-to-point	5-35
pin codes	5-52
point-to-point	5-35
radio communication	1-11
unpair	5-38, 5-39
pairing beeper definitions	5-5
parameter defaults	
radio communication	5-2
USB	8-4
parameters	
batch mode	5-45, 5-46
beep on insertion	5-34
Bluetooth technology support	5-20
number of retry attempts	5-32
radio communication	5-5
AutoConfig (scanner cloning through cradle) ...	
5-43	
auto-reconnect interval	5-26
batch mode	5-45, 5-46
connection maintenance interval	5-40
host types	5-5
pairing	5-36
parameter broadcast	5-36
reconnect attempt beep	5-27
reconnect attempt interval	5-28
scanner to cradle support	5-35
sleep between reconnect attempts	5-31
unpair	5-38, 5-39
USB	8-5
parts	1-3, 1-15
scanner	1-5
PDF417 bar codes	13-80
PDF prioritization	6-34
peripheral	5-10
PIN code	
static	5-53

- variable 5-53
- pinouts
 - scanner signal descriptions 4-12
- point-to-point communication 5-35
- postal codes 13-97
 - Australia post 13-100
 - Australia post format 13-101
 - Japan postal 13-99
 - Netherlands KIX code 13-102
 - transmit UK postal check digit 13-99
 - transmit US postal check digit 13-98
 - UK postal 13-98
 - UPU FICS postal 13-103
 - US planet 13-97
 - US postnet 13-97
 - USPS 4CB/One Code/Intelligent Mail 13-102
- power 1-7
- power supply 1-14, 1-18
 - connecting 1-18
- presentation mode 3-11
- presentation mode field of view 6-36
- product id (pid) value 6-49
- product id type 6-48
- product line configurations xxviii

Q

- QR code bar codes 13-84
- quick start guide 1-14, 1-18

R

- radio communication
 - bluetooth 1-3
 - bluetooth technology profile support 1-11
 - defaults 5-2
 - multipoint-to-point 5-35
 - number of retry attempts 5-32
 - pairing 1-11
 - parameters 5-5
 - point-to-point 5-35
 - reconnect attempt 5-28
 - reconnect attempt beep 5-27
 - sleep between reconnect attempts 5-31
- range indicator 5-34
- reconnect attempt 5-28
- reconnect attempt beep 5-27
- removing battery 1-8
- RS-232
 - connection 10-2
 - default parameters 10-4
 - parameters 10-5, 10-7
- RSM
 - commands and responses over SSI 9-8

S

- sample bar codes F-1
- scanner parts 1-5
- scanner to cradle support 5-35
- scanner(s) to cradle support 5-35
- scanning
 - aiming 3-12, 3-14
 - errors 6-2, 7-2, 8-10, 13-2
 - hand-held mode 3-9
 - hands-free mode 3-11
 - presentation mode 3-9
 - radio communications sequence example 5-1
 - sequence example 6-2, 7-2, 13-1
- secure simple pairing IO capability 5-54
- security
 - intercharacter gap size 13-108
 - quiet zone level 13-107
 - redundancy level 13-104
 - security level 13-106
- Serial Port Profile
 - central 5-26, 5-36
 - support 5-10
- service information xxxiv
- setting defaults 6-5
- setup
 - connecting a USB interface 8-1
 - connecting an RS-232 interface 10-2
 - connecting keyboard wedge interface 12-2
 - connecting power 1-18
 - connecting to an IBM 468X/469X host 11-2
 - inserting scanner in cradle 1-10
 - installing the cable 1-6
 - lost host connection 1-11
 - mounting cradle 1-7
 - supplying power 1-7
 - unpacking 1-2
- signal descriptions 4-12
- signature capture 7-20
 - bits per pixel 7-22
 - file format selector 7-21
 - height 7-23
 - JPEG quality 7-24
 - width 7-23
- simple serial interface
 - baud rate 9-12
 - commands 9-2
 - communications 9-1, 9-5
 - default parameters 9-10
 - handshaking 9-3, 9-5
 - RSM commands and responses 9-8
 - RTS CTS 9-5
 - selecting 9-11
 - transactions 9-3

Index - 10 DS36X8 Digital Scanner Product Reference Guide

sleep between reconnect attempts 5-31
snapshot mode timeout 7-8
specifications 4-7
SPP
 central 5-26, 5-36
 support 5-10
SSI
 baud rate 9-12
 commands 9-2
 communications 9-1, 9-5
 default parameters 9-10
 handshaking 9-3, 9-5
 RSM commands and responses 9-8
 RTS CTS 9-5
 selecting 9-11
 transactions 9-3
stored data
 batch mode 5-45
support xxxiv
 for IDC 14-3
symbology default parameters 13-2

T

technical specifications 4-7
trigger mode 6-22, 6-23
troubleshooting 4-3

U

unicode
 output control D-2
unlocked pairing mode 5-37
unpacking 1-2
unpairing
 bar code 5-38, 5-39
UPC/EAN bar codes
 bookland EAN 13-11
 bookland ISBN 13-23
 check digit 13-17, 13-18
 convert UPC-E to UPC-A 13-22
 convert UPC-E1 to UPC-A 13-22
 EAN zero extend 13-23
 EAN-13/JAN-13 13-11
 EAN-8/JAN-8 13-10
 ISSN EAN 13-25
 reduced quiet zone 13-17
 supplemental AIM ID format 13-16
 supplemental redundancy 13-15
 supplementals 13-12
 UCC coupon extended code 13-24
 UPC-A 13-9
 UPC-A preamble 13-19
 UPC-E 13-9

 UPC-E preamble 13-20
 UPC-E1 13-10
 UPC-E1 preamble 13-21
USB connection 8-1
USB defaults 8-4
USB parameters 8-5
user preferences bar codes
 batch mode 5-45, 5-46
 beep on insertion 5-34

V

video view finder 7-24
 image size 7-25

W

wi-fi friendly mode 5-13
 channel exclusion 5-14



Zebra Technologies Corporation, Inc.
Lincolnshire, IL 60069, U.S.A.
<http://www.zebra.com>

ZEBRA and the stylized Zebra head are trademarks of Zebra Technologies Corporation, registered in many jurisdictions worldwide. All other trademarks are the property of their respective owners. ©2024 Zebra Technologies Corporation and/or its affiliates. All rights reserved.

