

PowerScan™ 9300 Family

Laser Bar Code Reader

PowerScan PD9330/PBT9300/PM9300



Product Reference Guide

Datalogic USA, Inc.

959 Terry Street
Eugene, OR 97402
USA

Telephone: (541) 683-5700

Fax: (541) 345-7140

©2013-2017 Datalogic S.p.A. and/or its affiliates

▪ All rights reserved. ▪ Without limiting the rights under copyright, no part of this documentation may be reproduced, stored in or introduced into a retrieval system, or transmitted in any form or by any means, or for any purpose, without the express written permission of Datalogic S.p.A. and/or its affiliates.

Owners of Datalogic products are hereby granted a non-exclusive, revocable license to reproduce and transmit this documentation for the purchaser's own internal business purposes. Purchaser shall not remove or alter any proprietary notices, including copyright notices, contained in this documentation and shall ensure that all notices appear on any reproductions of the documentation.

Should future revisions of this manual be published, you can acquire printed versions by contacting your Datalogic representative. Electronic versions may either be downloadable from the Datalogic website (www.datalogic.com) or provided on appropriate media. If you visit our website and would like to make comments or suggestions about this or other Datalogic publications, please let us know via the "Contact Datalogic" page.

Disclaimer

Datalogic has taken reasonable measures to provide information in this manual that is complete and accurate, however, Datalogic reserves the right to change any specification at any time without prior notice.

Datalogic and the Datalogic logo are registered trademarks of Datalogic S.p.A. in many countries, including the U.S.A. and the E.U. The Bluetooth word mark and logos are owned by Bluetooth SIG, Inc. and any use of such marks by Datalogic Group companies is under license. PowerScan is a trademark of Datalogic S.p.A. and/or its affiliates, registered in many countries, including the U.S. and the E.U. All other trademarks and brands are property of their respective owners.

Patents

See www.patents.datalogic.com for patent list.



Table of contents

INTRODUCTION	1
About this Manual	1
Overview	1
Manual Conventions	2
References	2
Technical Support	2
Datalogic Website Support	2
Reseller Technical Support	2
Telephone Technical Support	2
About the Reader	3
PM8300 Compatible Mode:	3
The BC9xx0™ Base Station/Charger	4
Battery Safety	5
Programming the Reader	6
Configuration Methods	6
SETUP	7
Unpacking	7
Setting Up the Reader	7
Connecting the Cable (Corded versions)	8
Configuring the Base Station	9
Mounting the BC9xx0 Cradle	9
Mounting Brackets	9
Permanent Mounting	10
Mounting for Portable Use	11
System Connections	12
Connecting and Disconnecting the Interface Cable	13
BC9xx0 Configuration	14
Interface Selection	14
Setting the Interface	14
Customizing Configuration Settings	17
Configure Interface Settings	17
Global Interface Features	17
Configuring Other Features	17
Software Version Transmission	17
Resetting the Product Configuration to Defaults	17
Set Date and Time	18
Linking the Reader	19
Link Datalogic RF Devices to Base	19
Linking to a Bluetooth Adapter in Serial Port Profile (Slave) Mode	19
Linking to a Bluetooth Adapter in Serial Port Profile (Master) Mode	19
Linking to a Bluetooth Adapter in HID mode	20
Power Off	20
CONFIGURATION USING BAR CODES	21
Configuration Parameters	21
GLOBAL INTERFACE FEATURES	23
Host Commands — Obey/Ignore	23
RS-232 Only Interface	25
Baud Rate	26
Stop Bits	27
.....	27
Parity	27
Handshaking Control	28
RS-232/USB-Com Interfaces	29
Intercharacter Delay	30
Beep On ASCII BEL	30
Beep On Not on File	31

ACK NAK Options	31
ACK Character	32
NAK Character	32
ACK NAK Timeout Value	33
ACK NAK Retry Count	33
ACK NAK Error Handling	34
Indicate Transmission Failure	34
Disable Character	35
Enable Character	35
Keyboard EMULATION Settings	37
Country Mode	38
Send Control Characters	41
Wedge Quiet Interval	42
Intercode Delay	42
Caps Lock State	43
Numlock	43
USB Keyboard Speed	44
USB Keyboard Numeric Keypad	45
USB-OEM Interface	47
USB-OEM Device Usage	48
Interface Options	48
Data Format	49
Global Prefix/Suffix (Header/Terminator)	50
Global AIM ID	51
Set AIM ID Individually for GS1-128	53
LABEL ID	54
Label ID: Pre-Loaded Sets	54
INDIVIDUALLY SET LABEL ID	55
Label ID Control	55
Label ID Symbology Selection	56
ADVANCED FORMATTING: USER LABEL EDIT	61
Case Conversion	61
Character Conversion	62
Reading Parameters	63
Double Read Timeout	64
LED AND BEEPER INDICATORS	66
Power On Alert	66
Good Read: When to Indicate	66
Good Read Beep Type	67
Good Read Beep Frequency	67
Good Read Beep Length	68
Good Read Beep Volume	69
Good Read LED Duration	70
SCANNING FEATURES	71
Scan Mode	71
Scanning Active Time	72
Flash On Time	72
Flash Off Time	73
Aiming Pointer	73
Green Spot Duration	74
Symbologies	75
DISABLE ALL SYMBOLOGIES	77
CODE EAN/UPC	78
Coupon Control	78
UPC-A	79
UPC-A Enable/Disable	79
UPC-A Check Character Transmission	79
Expand UPC-A to EAN-13	80
UPC-A Number System Character Transmission	80
In-Store Minimum Reads	81
UPC-E	82
UPC-E Enable/Disable	82
UPC-E Check Character Transmission	82
Expand UPC-E to EAN-13	83
Expand UPC-E to UPC-A	83
UPC-E Number System Character Transmission	84

UPC-E Minimum Read	84
GTIN FORMATTING	85
EAN 13 (JAN 13)	85
EAN 13 Enable/Disable	85
EAN 13 Check Character Transmission	86
EAN-13 Flag 1 Character	86
EAN-13 ISBN Conversion	86
ISSN	87
ISSN Enable/Disable	87
EAN 13 Minimum Reads	87
EAN 8	88
EAN 8 Enable/Disable	88
EAN 8 Check Character Transmission	88
EAN 8 to EAN 13	89
EAN 8 Minimum Reads	89
UPC/EAN GLOBAL SETTINGS	90
UPC/EAN Decoding Levels	90
UPC/EAN Price Weight Check	91
UPC-A Minimum Reads	92
UPC/EAN Quiet Zones	92
ADD-ONS	93
Optional Add-ons	93
Optional Add-On Timer	94
P2 Add-Ons Minimum Reads	95
P5 Add-Ons Minimum Reads	96
CODE 39	97
Code 39 Enable/Disable	97
Code 39 Check Character Calculation	97
Code 39 Check Character Transmission	98
Code 39 Start/Stop Character Transmission	99
Code 39 Full ASCII	99
Code 39 Quiet Zones	100
Code 39 Minimum Reads	101
Code 39 Decoding Levels	102
Code 39 Length Control	103
Code 39 Set Length 1	104
Code 39 Set Length 2	105
Code 39 Interdigit Ratio	106
CODE 32 (ITAL PHARMACEUTICAL CODE)	107
Code 32 Enable/Disable	107
Code 32 Feature Setting Exceptions	107
Code 32 Check Character Transmission	107
Code 32 Start/Stop Character Transmission	108
CODE 39 CIP (FRENCH PHARMACEUTICAL)	108
Code 39 CIP Enable/Disable	108
CODE 128	109
Code 128 Enable/Disable	109
Expand Code 128 to Code 39	109
Code 128 Check Character Transmission	110
Code 128 Function Character Transmission	110
Code 128 Sub-Code Exchange Transmission	111
Code 128 Quiet Zones	111
Code 128 Minimum Reads	112
Code 128 Decoding Levels	113
Code 128 Length Control	114
Code 128 Set Length 1	115
Code 128 Set Length 2	116
GS1-128	117
GS1-128 Enable	117
CODE ISBT 128	118
ISBT 128 Concatenation	118
ISBT 128 Force Concatenation	118
ISBT 128 Concatenation Mode	119
ISBT 128 Dynamic Concatenation Timeout	120
ISBT 128 Advanced Concatenation Options	121
INTERLEAVED 2 OF 5 (I 2 OF 5)	121
I 2 of 5 Enable/Disable	121

1 2 of 5 Check Character Calculation	122
1 2 of 5 Check Character Transmission	123
1 2 of 5 Minimum Reads	123
1 2 of 5 Decoding Levels	124
1 2 of 5 Length Control	125
1 2 of 5 Set Length 1	126
1 2 of 5 Set Length 2	127
1 2 of 5 Zero Pattern	128
INTERLEAVED 2 OF 5 CIP HR	129
Interleaved 2 of 5 Enable/Disable	129
DATALOGIC 2 OF 5	130
Datalogic 2 of 5 Enable/Disable	130
Datalogic 2 of 5 Check Character Calculation	130
Datalogic 2 of 5 Check Character Transmission	131
Datalogic 2 of 5 Minimum Reads	131
Datalogic 2 of 5 Decoding Levels	131
Datalogic 2 of 5 Length Control	132
Datalogic 2 of 5 Set Length 1	132
Datalogic 2 of 5 Set Length 2	133
Datalogic 2 of 5 Interdigit Maximum Ratio	134
FOLLETT 2 OF 5 (ONLY STANDARD OPTIC MODELS)	135
Follett 2 of 5 Enable/Disable	135
STANDARD 2 OF 5	136
Standard 2 of 5 Enable/Disable	136
Standard 2 of 5 Check Character Calculation	136
Standard 2 of 5 Check Character Transmission	137
Standard 2 of 5 Minimum Reads	137
Standard 2 of 5 Decoding Levels	138
Standard 2 of 5 Length Control	138
Standard 2 of 5 Set Length 1	139
Standard 2 of 5 Set Length 2	140
INDUSTRIAL 2 OF 5 (ONLY STANDARD OPTIC MODELS)	141
Industrial 2 of 5 Enable/Disable	141
Industrial 2 of 5 Check Character Calculation	141
Industrial 2 of 5 Check Character Transmission	142
Industrial 2 of 5 Length Control	142
Industrial 2 of 5 Set Length 1	143
Industrial 2 of 5 Set Length 2	144
Industrial 2 of 5 Minimum Reads	145
CODE IATA (ONLY STANDARD OPTIC MODELS)	146
IATA Enable/Disable	146
IATA Check Character Transmission	146
CODABAR	147
Codabar Enable/Disable	147
Codabar Check Character Calculation	147
Codabar Check Character Transmission	148
Codabar Start/Stop Character Transmission	148
Codabar Start/Stop Character Set	149
Codabar Start/Stop Character Match	149
Codabar Quiet Zones	150
Codabar Minimum Reads	151
Codabar Decoding Levels	152
Codabar Length Control	153
Codabar Set Length 1	154
Codabar Set Length 2	155
Codabar Interdigit Ratio	156
ABC CODABAR	158
ABC Codabar Enable/Disable	158
ABC Codabar Concatenation Mode	158
ABC Codabar Dynamic Concatenation Timeout	159
ABC Codabar Force Concatenation	159
CODE 11 (ONLY STANDARD OPTIC MODELS)	160
Code 11 Enable/Disable	160
Code 11 Check Character Calculation	160
Code 11 Check Character Transmission	161
Code 11 Minimum Reads	161
Code 11 Length Control	162

Code 11 Set Length 1	163
Code 11 Set Length 2	164
Code 11 Interdigit Ratio	165
Code 11 Decoding Levels	167
GS1 DATABAR™ OMNIDIRECTIONAL	168
GS1 DataBar™ Omnidirectional Enable/Disable	168
GS1 DataBar™ Omnidirectional GS1-128 Emulation	168
GS1 DataBar™ Omnidirectional Minimum Reads	169
GS1 DATABAR™ EXPANDED	170
GS1 DataBar™ Expanded Enable/Disable	170
GS1 DataBar™ Expanded GS1-128 Emulation	170
GS1 DataBar™ Expanded Minimum Reads	171
GS1 DataBar™ Expanded Length Control	172
GS1 DataBar™ Expanded Set Length 1	173
GS1 DataBar™ Expanded Set Length 2	174
GS1 DATABAR™ LIMITED	175
GS1 DataBar™ Limited Enable/Disable	175
GS1 DataBar™ Limited GS1-128 Emulation	175
GS1 DataBar™ Limited Minimum Reads	176
CODE 93	177
Code 93 Enable/Disable	177
Code 93 Check Character Calculation	177
Code 93 Check Character Transmission	178
Code 93 Length Control	178
Code 93 Set Length 1	179
Code 93 Set Length 2	180
Code 93 Minimum Reads	181
Code 93 Decoding Levels	182
Code 93 Quiet Zones	183
CODABLOCK F	184
Codablock F Enable/Disable	184
Codablock F EAN Enable/Disable	184
Codablock F AIM Check	185
Codablock F Length Control	185
Codablock F Set Length 1	186
Codablock F Set Length 2	187
CODE 4	188
Code 4 Enable/Disable	188
Code 4 Check Character Transmission	188
Code 4 Hex to Decimal Conversion	189
CODE 5	190
Code 5 Enable/Disable	190
Code 5 Check Character Transmission	190
Code 5 Hex to Decimal Conversion	191
CODE 4 AND CODE 5 COMMON CONFIGURATION ITEMS	192
Code 4 and 5 Decoding Levels	192
Code 4 and Code 5 Minimum Reads	193
BC412	194
BC412 Enable/Disable	194
BC412 Check Character Calculation	194
BC412 Minimum Reads	195
BC412 Decoding Levels	196
BC412 Length Control	197
BC412 Set Length 1	198
BC412 Set Length 2	199
MSI	200
MSI Enable/Disable	200
MSI Check Character Calculation	200
MSI Check Character Transmission	201
MSI Length Control	201
MSI Set Length 1	202
MSI Set Length 2	203
MSI Minimum Reads	204
MSI Decoding Levels	205
PLESSEY (ONLY STANDARD OPTIC MODELS)	206
Plessey Enable/Disable	206
Plessey Check Character Calculation	206

Plessey Check Character Transmission	207
Plessey Length Control	207
Plessey Set Length 1	208
Plessey Set Length 2	209
Plessey Minimum Reads	210
Plessey Decoding Levels	211
Wireless Features	213
WIRELESS BEEPER FEATURES	217
Good Transmission Beep	217
Beep Frequency	217
Beep Duration	218
Beep Volume	219
Disconnect Beep	219
Leash Alarm	220
CONFIGURATION UPDATES	222
Automatic Configuration Update	222
Copy Configuration to Scanner	223
Copy Configuration to Base Station	223
BATCH FEATURES	224
Batch Mode	224
Send Batch	225
.....	225
Erase Batch Memory	225
RF Batch Mode Transmit Delay	226
DIRECT RADIO AUTOLINK	227
RF ADDRESS STAMPING	227
Source Radio Address Transmission	227
Source Radio Address Delimiter Character	228
REAL TIME CLOCK (RTC) CONFIGURATION	229
Current Date	229
Current Time	229
Date Tx Format	230
Time Tx Format	231
Date-Time Separator	231
Date-Time Transmission Order	232
Power Off	233
Powerdown Timeout	233
PBT9300-Only Features.....	234
BLUETOOTH SECURITY FEATURES	234
Bluetooth Security Mode	235
Bluetooth PIN Code	235
Select PIN Code Length	235
Set PIN Code	236
OTHER BLUETOOTH FEATURES	237
Reconnect Attempt Interval	237
Bluetooth HID Variable PIN Code	238
Bluetooth HID Alt Mode	239
Bluetooth Max Client	239
Bluetooth Friendly Name	241
Bluetooth Reconnect Attempt Mode	242
HID Country Mode	243
PM9300-Only Features.....	247
STAR Radio Protocol Timeout	247
STAR Radio Transmit Mode	248
Radio Sleep	249
Changing System Speed	250
Frequency Agility	251
Compatibility with PM8300.....	252
Compatibility Mode	252
Display and Keyboard Features.....	252
Display Operating Mode	252
Display Off Timeout	253
Backlight Enable	254
Display Contrast	255
Font Size	255
Enable/Disable Buttons	256

Arrow Keys Mode (4-key models only)	258
Configure Custom Label String for Arrow Up Key (4-key models only)	259
Configure Custom Label String for Arrow Down Key (4-key models only)	259
CONFIGURE ACTIONS FOR FUNCTION KEYS	260
ACTION CONFIGURATION FOR FUNCTION KEYS	261
Configure Actions for F1	261
Configure Actions for F2	262
FUNCTION KEYS CONFIGURATION (16-KEY MODELS ONLY)	263
Configure Actions for F3 (16-key models only)	263
Configure Actions for F4 (16-key models only)	263
Configure Actions for Shift (16-key models only)	264
Define Strings	265
Set String ID	266
Set String Header	266
Set String Terminator	267
ADDITIONAL FEATURES FOR 16-KEY MODELS	268
Last Code Shown Timeout	268
Display Time Stamping Mode	269
Mode Selection	270
Quantity Field	271
Quantity/Code Send Mode	272
Quantity/Code Separator	273
Interkey Timeout	274
Append Code	275
Echo	276
Keypress Sound	277
SHIFT Enable/Disable	277
SHIFT Key Association	278
Lower Case	279
SET FUNCTION KEY LABELS	280
Set F1 Label	280
Set F2 Label	280
Set F3 Label	281
Set F4 Label	281
Barcode/Key Different Data Format	282
Set Barcode Header	282
Set Barcode Terminator	283
Set Key Sequence ID	283
Set Key Sequence Header	283
Set Key Sequence Terminator	284
REFERENCES	285
RS-232 Parameters	286
RS-232 Only	286
RS-232/USB COM Parameters	287
Keyboard Interface	294
Wedge Quiet Interval	294
Intercharacter Delay	295
Intercode Delay	296
Symbologies	297
Decoding Safety	297
Set Length	297
Data Editing	299
Global Prefix/Suffix	300
Global AIM ID	301
Label ID	302
Character Conversion	306
Reading Parameters	307
Good Read LED Duration	307
Scanning Features	308
Scan Mode	308
Wireless Features	310
Automatic Configuration Update	310
RF Address Stamping	310
Bluetooth-Only Features	312
MESSAGE FORMATTING	313
Cursor Control	314

Contents

Font Selection	314
Clearing Display	314
LED and Beeper Control	315
Setting RTC	315
TECHNICAL SPECIFICATIONS	317
Imager Labeling	321
Standard Cable Pinouts	321
LED and Beeper Indications	322
Base Station Indications (Cordless Models ONLY)	323
SAMPLE BAR CODES.....	325
1D Bar Codes	325
GS1 DataBar (RSS)	327
GS1 DataBar-14	327
STANDARD DEFAULTS.....	329
KEYPAD.....	343
SCANCODE TABLES.....	345
Control Character Emulation	345
Single Press and Release Keys	345
Interface Type PC AT PS/2, USB-Keyboard	346
Interface Type PC AT PS/2 Alt Mode or USB-Keyboard Alt Mode	348
.....	349



Chapter 1

Introduction

About this Manual

This Product Reference Guide (PRG) is provided for users seeking advanced technical information, including connection, programming, maintenance and specifications. The Quick Reference Guide (QRG) and other publications associated with this product are downloadable free of charge from the website listed on the back cover of this manual.

Overview

[Chapter 1](#), (this chapter) presents information about manual conventions, and an overview of the reader, its features and operation.

[Chapter 2, Setup](#) presents information about unpacking, cable connection information and setting up the reader.

[Chapter 3, Configuration Using Bar Codes](#) provides instructions and bar code labels for customizing your reader. There are different sections for interface types, general features, data formatting, symbology-specific and model-specific features.

[Chapter 4, References](#) provides background information and detailed instructions for more complex programming items.

[Chapter 5, Message Formatting](#) gives details for programming options.

[Appendix A, Technical Specifications](#) lists physical and performance characteristics, as well as environmental and regulatory specifications. It also provides standard cable pinouts and LED/Beeper functions.

[Appendix B, Sample Bar Codes](#) offers sample bar codes for several common symbologies.

[Appendix C, Standard Defaults](#) references common factory default settings for reader features and options.

[Appendix D, Keypad](#) includes numeric bar codes to be scanned for certain parameter settings.

[Appendix E, Scancode Tables](#) lists control character emulation information for Wedge and USB Keyboard interfaces.

Manual Conventions

The following conventions are used in this document:

The symbols listed below are used in this manual to notify the reader of key issues or procedures that must be observed when using the reader:



Notes contain information necessary for properly diagnosing, repairing and operating the reader.



The CAUTION symbol advises you of actions that could damage equipment or property.

References

Current versions of this Product Reference Guide (PRG), Quick Reference Guide (QRG), the Datalogic Aladdin™ Configuration application, and any other manuals, instruction sheets and utilities for this product can be downloaded from the website listed below. Alternatively, printed copies or product support CDs for most products can be purchased through your Datalogic reseller.

Technical Support

Datalogic Website Support

The Datalogic website (www.datalogic.com) is the complete source for technical support and information for Datalogic products. The site offers product support, warranty information, product manuals, product tech notes, software updates, demos, and instructions for returning products for repair.

Reseller Technical Support

An excellent source for technical assistance and information is an authorized Datalogic reseller. A reseller is acquainted with specific types of businesses, application software, and computer systems and can provide individualized assistance.

Telephone Technical Support

If you do not have internet or email access, you may contact Datalogic technical support at (541) 349-8283 or check the back cover of your manual for more contact information.

About the Reader

The PowerScan 9300 is a family of feature-rich and rugged laser readers. It is offered in several different models to better fit the different needs of each customer.

The main model categories are:

- PD9330-XX: Corded models.
- PM9300-XX: STAR-System(tm) models.
- PBT9300-XX: Bluetooth models.

Within each category, further differentiating features are available, described by the part number suffix:

- AR: Autorange optic, standard and low density code, long depth of field
- D: models equipped with display and 4-key keyboard
- DK: models equipped with display and 16-key keyboard

Typically, units are factory-programmed for the most common terminal and communications settings. If you need to modify any programmable settings, custom configuration can be done by scanning the programming barcodes within this guide or with Datalogic Aladdin™, available from the Datalogic website. See "[Datalogic Aladdin™](#)" on page 6 for more information.

Whether used in Single Trigger or Continuous Mode, the ergonomic design of the reader will help to promote comfortable handling during extended periods of use.

See "[Interface Selection](#)" on page 14 for a listing and descriptions of available interface sets by model type.

PM8300 Compatible Mode:

Powerscan PM9300 offers a limited set of features compatible with the previous PM8300. To access those features, you have to program the system through the Compatibility Mode parameter (see "[Compatibility Mode](#)" on page 252 of the Wireless Configuration chapter).

When in normal mode, the same parameter can be used to configure the communication speed.

The BC9xx0™ Base Station/Charger

The BC9xx0 base station, when paired with one or more PowerScan™ 9300 readers, builds a Cordless Reading System for the collection, decoding and transmission of bar code data. It can be connected to a Host PC via RS-232, USB, or KBD Wedge, and is suited for single-cradle layouts. The BC91x0 models also provide a spare battery charger slot.

The label on the cradle contains LED indicators and a multi-function button. When the button is pressed for less than 5 seconds, the cradle will transmit a "broast" message." When the broast is sent, all properly configured scanners (Radio RX Timeout set to keep the radio "awake") that are linked to that base and within radio range coverage will emit a beep and blink within 5 seconds. This functionality is useful to:

- verify which scanners are linked to a certain base station
- detect a scanner forgotten somewhere



When the button is pressed for longer than 5 seconds, all paired scanners will be unpaired.

The LEDs signal the BC9xx0-BT status, as shown in the following table.

Table 1. LED Status

LED	STATUS
Aux	Yellow On = BC9xx0 is powered through an external power supply.
Host	Yellow On = BC9xx0 is powered by the Host.
Reader	Green On = the reader battery is completely charged. Red On = the reader battery is charging. Orange Blinking = reader battery fault - replace battery. Off = reader not in the cradle or not properly inserted.
Spare (BC91x0 models only)	Green On = the spare battery is completely charged. Orange Blinking = spare battery fault - replace spare battery. Off = no spare battery in the housing or battery not fully inserted.
Radio	Yellow Blinking = radio activity.
Ethernet (Ethernet models only)	Green Blinking = Et14hernet activity.

See "Base Station Indications (Cordless Models ONLY)" on page 323 for more specific details on the LEDs.

Battery Safety

To reinstall, charge and/or perform any other action on the battery, follow the instructions in this manual.



Before installing the Battery, read "Battery Safety" on this and the following pages. Datalogic recommends annual replacement of rechargeable battery packs to ensure maximum performance.



Do not discharge the battery using any device except for the scanner. When the battery is used in devices other than the designated product, it may damage the battery or reduce its life expectancy. If the device causes an abnormal current to flow, it may cause the battery to become hot, explode or ignite and cause serious injury.

Lithium-ion battery packs may get hot, explode or ignite and cause serious injury if exposed to abusive conditions. Be sure to follow the safety warnings listed below:

- Do not place the battery pack in fire or heat.
- Do not connect the positive terminal and negative terminal of the battery pack to each other with any metal object (such as wire).
- Do not carry or store the battery pack together with metal objects.
- Do not pierce the battery pack with nails, strike it with a hammer, step on it or otherwise subject it to strong impacts or shocks.
- Do not solder directly onto the battery pack.
- Do not expose the battery pack to liquids, or allow the battery to get wet.
- Do not apply voltages to the battery pack contacts.

In the event the battery pack leaks and the fluid gets into your eye, do not rub the eye. Rinse well with water and immediately seek medical care. If left untreated, the battery fluid could cause damage to the eye.



Always charge the battery at 32° – 104° F (0° - 40° C) temperature range.

Use only the authorized power supplies, battery pack, chargers, and docks supplied by your Datalogic reseller. The use of any other power supplies can damage the device and void your warranty.

Do not disassemble or modify the battery. The battery contains safety and protection devices, which, if damaged, may cause the battery to generate heat, explode or ignite.

Do not place the battery in or near fire, on stoves or other high temperature locations.

Do not place the battery in direct sunlight, or use or store the battery inside cars in hot weather. Doing so may cause the battery to generate heat, explode or ignite. Using the battery in this manner may also result in a loss of performance and a shortened life expectancy.

Do not place the battery in microwave ovens, high-pressure containers or on induction cookware.

Immediately discontinue use of the battery if, while using, charging or storing the battery, the battery emits an unusual smell, feels hot, changes color or shape, or appears abnormal in any other way.

Do not replace the battery pack when the device is turned on.

Do not remove or damage the battery pack's label.

Do not use the battery pack if it is damaged in any part.

Battery pack usage by children should be supervised.

As with other types of batteries, Lithium-Ion (LI) batteries will lose capacity over time. Capacity deterioration is noticeable after one year of service whether the battery is in use or not. It is difficult to precisely predict the finite life of a LI battery, but cell manufacturers rate them at 500 charge cycles. In other words, the batteries should be expected to take 500 full dis-

charge / charge cycles before needing replacement. This number is higher if partial discharging / recharging is adhered to rather than full / deep discharging,

The typical manufacturer advertised useful life of LI batteries is one to three years, depending on usage and number of charges, etc., after which they should be removed from service, especially in mission critical applications. Do not continue to use a battery that is showing excessive loss of capacity, it should be properly recycled / disposed of and replaced. For most applications, batteries should be replaced after one year of service to maintain customer satisfaction and minimize safety concerns.

Collect and recycle waste batteries separately from the device in compliance with European Directive 2006/66/EC, 2011/65/EU, 2002/96/EC and 2012/19/EU and subsequent modifications, US and China regulatory and others laws and regulations about the environment.

Programming the Reader

Configuration Methods

Programming Bar Codes

The reader is factory-configured with a standard set of default features. After scanning the interface bar code, you can select other options and customize your reader through use of the instructions and programming bar code labels available in the corresponding features section for your interface. Customizable settings for many features are found in "[Configuration Parameters](#)" starting on page 21.

Some programming labels, like "[Restore Custom Defaults](#)" on page 17, require only the scan of the single label to enact the change. Most, however, require the reader to be placed in Programming Mode prior to scanning them. Scan an ENTER/EXIT bar code once to enter Programming Mode. Once the reader is in Programming Mode, scan a number of parameter settings before scanning the ENTER/EXIT bar code a second time, which will then accept your changes, exit Programming Mode and return the reader to normal operation.



There are some exceptions to the typical programming sequence described above. Please read the description and setting instructions carefully when configuring each programmable feature.

Datalogic Aladdin™

Datalogic Aladdin™ is a multi-platform utility program providing a quick and user-friendly configuration method via the RS-232/USB-COM interface. Aladdin allows you to program the reader by selecting configuration commands through a user-friendly graphical interface running on a PC. These commands are sent to the reader over the selected communication interface, or they can be printed as bar codes to be scanned. Aladdin also facilitates image capturing.

In addition, Aladdin makes it easy to upgrade the handheld's firmware, to attain the benefits of new reader features. Reference the Datalogic Aladdin™ Online Help for more details.

Aladdin is available for download free of charge on the Datalogic website.



Chapter 2 Setup

Unpacking

Check carefully to ensure the reader and any accessories ordered are present and undamaged. If any damage occurred during shipment, contact Datalogic Technical Support. Information is shown on [page 2](#).

KEEP THE PACKAGING. Should the unit ever require service, it should be returned in its original shipping container.

Setting Up the Reader

Follow the steps below to connect and get your reader up and communicating with its host.

1. Begin by Installing the Interface Cable (Corded) or Connecting the Base Station (Bluetooth and STAR)
2. Configure Interface Settings (see [page 14](#)).
3. Configure the Reader starting on [page 17](#) (optional, depends on settings needed)

Connect the PowerScan by plugging directly into the host device as shown. The power can also be supplied through an external power supply via the Interface Cable supplied with a power jack.

Connecting the Cable (Corded versions)

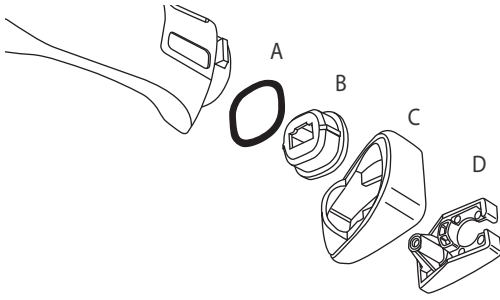

- A. Rubber gasket
- B. Cable Holder
- C. Cover
- D. Connector Holder

1. Slip the cable through the Cover.
2. Push the Rubber Gasket onto the Cable Holder.
3. Push the Cable Holder and gasket into the handle. Ensure that the “Front” marking on the Cable Holder is facing out, with the arrow pointing towards the front of the scanner.
4. Insert the end of the cable into the socket of the Cable Holder.
5. Push the Cover along the cable towards the reader, and hook it over the yellow “tooth” on the back of the handle.
6. Insert the cable through the Connector Holder, and push it up into the Cover.
7. Insert and tighten the screw to affix the cable assembly to the reader handle.

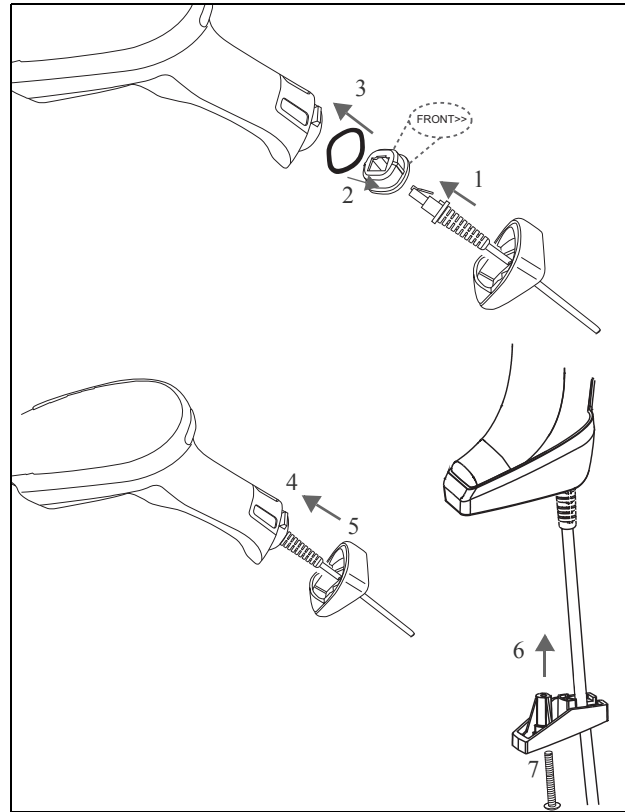

Configuring the Base Station

To set up your BC9xx0 cradle you must:

1. Physically install the cradle.
2. Make all system connections.
3. Configure the BC9xx0 cradle.

Mounting the BC9xx0 Cradle

The cradle package contains the following items:

BC9xx0 Base Station (with Desktop Mounting Bracket installed)	1 Metal Mounting plate
BC9xx0 Quick Reference Guide (this manual)	1 Wall Mounting Bracket

The cradle can be either mounted on a flat surface for desktop usage or affixed vertically to a wall.

Mounting Brackets

The cradle comes with two different mounting brackets. The appropriate bracket is used depending on whether the cradle will be mounted on a horizontal or vertical surface. When shipped, the cradle has the Desktop Mounting Bracket installed. For vertical installation, the Wall Mounting Bracket must be attached instead.

Figure 1. Mounting Brackets

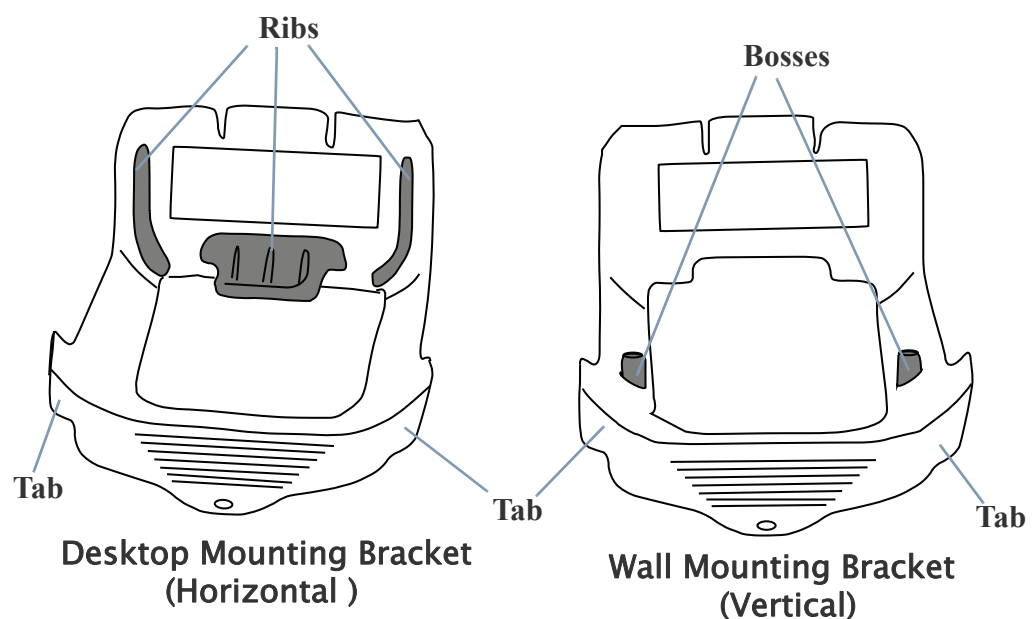

- Desktop mount bracket has ribs to keep the scanner in place when the cradle is horizontal.
- Wall mount bracket contains bosses to keep the scanner in place when the cradle is vertical.

To change the Bracket:

1. Remove the screw holding the Bracket in place. Retain the screw for re-use.
2. Carefully lift off the Bracket.
3. Install the other bracket by first slipping the end tab into place on the base station, then easing the tabs (shown in Figure 1 on page 9) into place on the sides.
4. Replace the screw to secure the Bracket to the Base Station.

Figure 2. Changing the Bracket

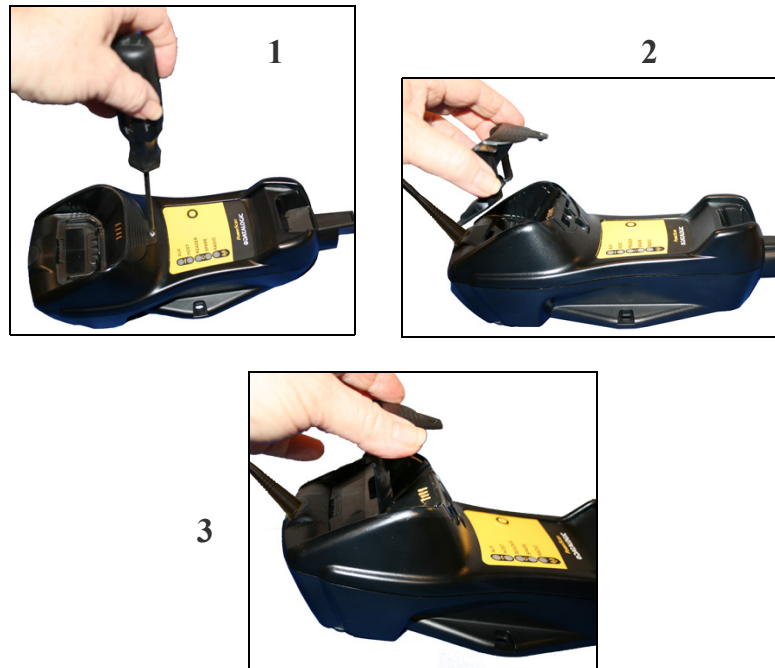

Permanent Mounting

For either desktop or wall mounting, the cradle can be fastened directly to a flat surface using screws (not included).

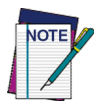

When mounting on drywall, the base should be screwed to a wall stud or supporting beam for additional support.

Figure 3. Base Station Bottom

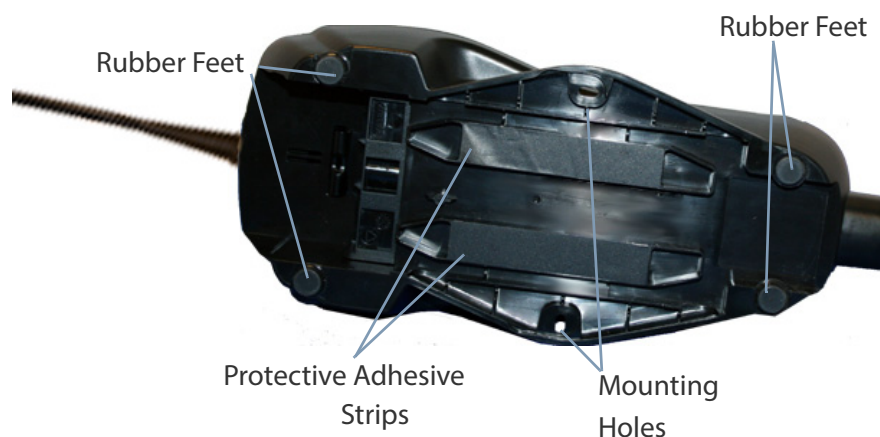

Mounting for Portable Use

If portability of the cradle is required, the metal plate must be used. There are two ways this can be done: (1) by first mounting the metal plate on a flat surface so the cradle can be slid off and on, or (2) mounting the metal plate onto the back of the base station and then screwing both to the desired surface.



For additional security on wall mounting, it is strongly recommended that the cradle be secured into place using two auxiliary screws through the mounting holes on the side.

Mounting the Metal Plate

1. Affix the metal plate onto the desired mounting surface using the two center screw holes (see Figure 4).
2. Remove the adhesive strips protecting the mounting tabs on the cradle, shown in Figure 3.
3. Slide the tabs on the back of the cradle onto the metal plate as shown in Figure 4.
4. After aligning the tabs, push up to lock into place.

Figure 4. Mounting Plate on Wall

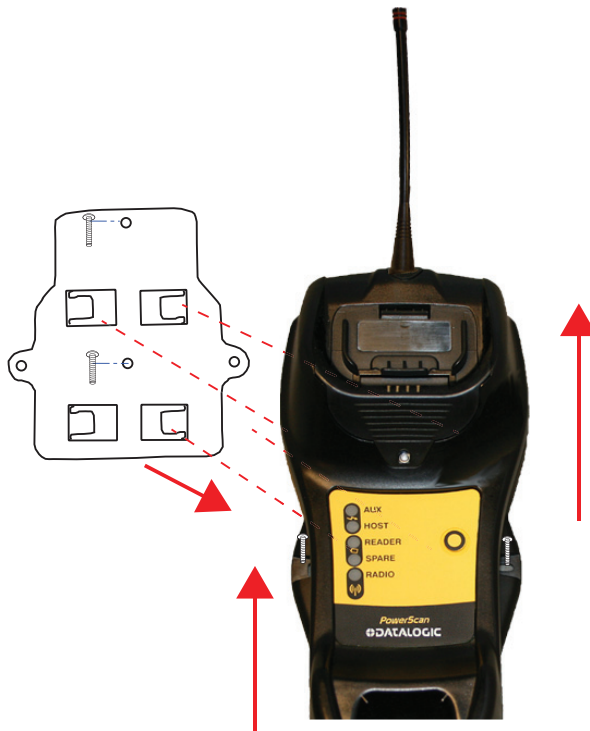

Attaching the Metal Plate to Base

Alternatively, the mount can be attached first to the base, then both can be mounted to a wall as described above.

Figure 5. Attaching Mounting Plate to Base

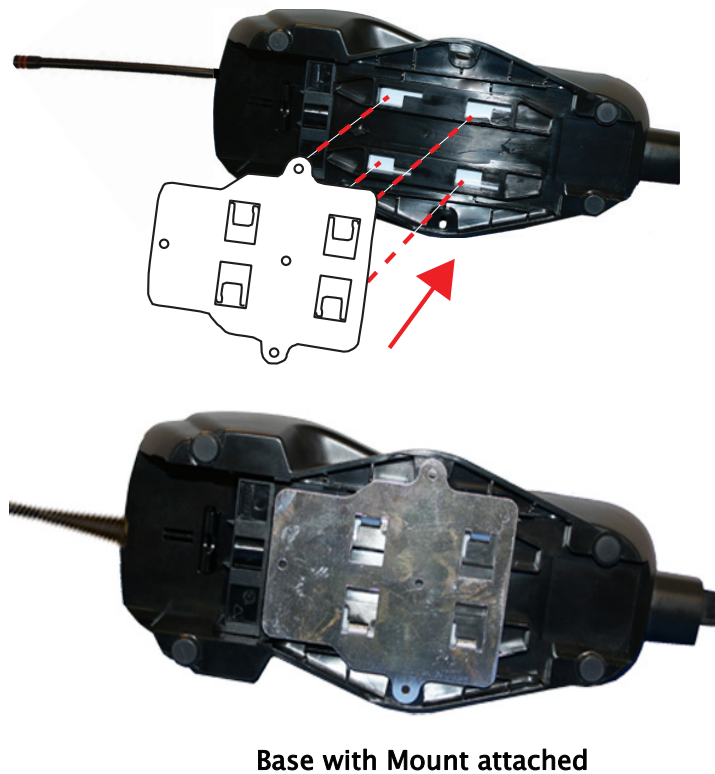

System Connections



Connections should always be made with power off!

The BC9xx0 cradle provides a multi-interface connector and a power supply connector as shown:

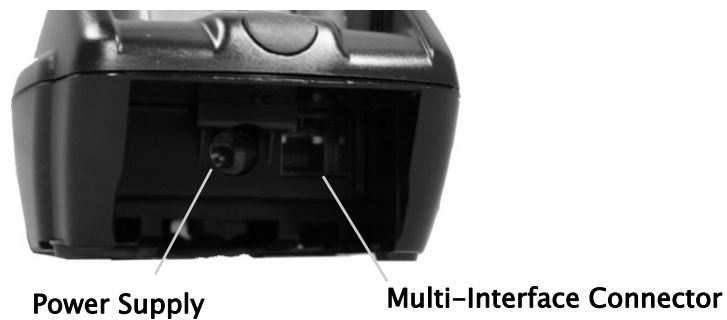

Connecting and Disconnecting the Interface Cable

The BC9xx0 can be connected to a Host by means of a multi-interface cable, which must be simply plugged into the Host connector, visible on the front panel of the cradle.

To disconnect the cable, insert a paper clip or other similar object into the hole corresponding to the Host connector on the body of the cradle. Push down on the clip while unplugging the cable. Refer to the following figures:

Connecting/Disconnecting the Cable

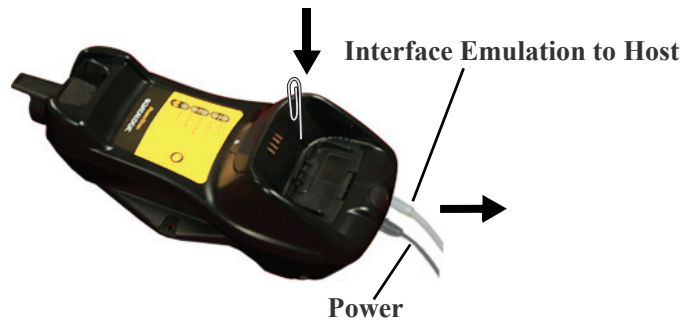

RS-232



USB*



*The power supply is optional, the cradle can be powered by the USB port. In this case the full charging of an empty battery will take about 10 hours. For intense usage and/or when the system is shut down during the night, the use of an external power supply is recommended.

WEDGE

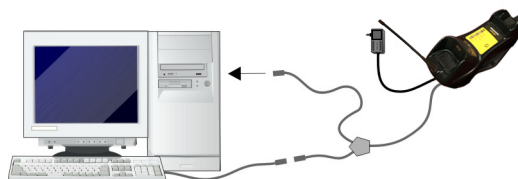

BC9xx0 Configuration

The BC9xx0 configuration can be performed in three ways: by using the Datalogic Aladdin™ software configuration program, by sending configuration strings from the Host PC via the RS-232 or USB-COM interface or by reading configuration bar codes with the PowerScan™ 9300 reader.

Serial Configuration

By connecting the BC9xx0 to a PC through an RS-232 or USB-COM interface cable it is possible to send configuration strings from the PC to BC9xx0.

Configuration Bar Codes

Link the cradle and the reader using the procedures described in the PowerScan™ PM9300 or PBT9300 Quick Reference. Once the pairing is complete, you can configure the BC9xx0 cradle by reading configuration bar codes in this manual.

To configure the BC9xx0 using the PowerScan™ 9300 reader (paired to the cradle with the Bind command), follow the procedure according to the interface selected.

Interface Selection

Upon completing the physical connection between the reader and its host, proceed to [Table 2 on page 15](#) to select the interface type the reader is connected to (for example: RS-232, Keyboard Wedge, USB, etc.). Scan the appropriate bar code in that section to configure your system's correct interface type.

Setting the Interface





Scan the programming bar code from this section which selects the appropriate interface type matching the system the reader will be connected to. Next, proceed to the corresponding section in this manual (also listed in [Table 2 on page 15](#)) to configure any desired settings and features associated with that interface.

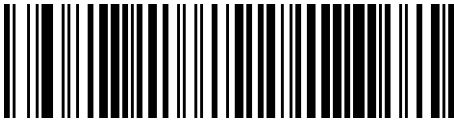

Unlike some programming features and options, interface selections require that you scan only one programming bar code label. **DO NOT** scan an ENTER/EXIT bar code prior to scanning an interface selection bar code.

Some interfaces require the scanner to start in the disabled state when powered up. If additional scanner configuration is desired while in this state, pull the trigger and hold it for five seconds. The scanner will change to a state that allows programming with bar codes.

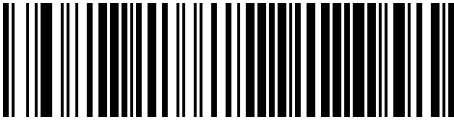
Table 2. Available Interfaces

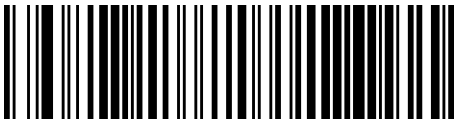
RS-232		FEATURES
RS-232 standard interface	 Select RS232-STD	Set RS-232 Interface Features starting on page 25
 Select RS232-WN	RS-232 Wincor-Nixdorf	
RS-232 for use with OPOS/UPOS/JavaPOS	 Select RS232 OPOS	
USB		FEATURES
 Select USB COM-STD ^a	USB Com to simulate RS-232 standard interface	Set USB-OEM Interface Features starting on page 47
USB-OEM (can be used for OPOS/UPOS/JavaPOS)	 Select USB-OEM	
 Select USB Keyboard	USB Keyboard with standard key encoding	
USB Keyboard with alternate key encoding	 Select USB Alternate Keyboard	

a. Download the correct USB Com driver from www.datalogic.com

KEYBOARD	FEATURES
<p>AT, PS/2 25-286, 30-286, 50, 50Z, 60, 70, 80, 90 & 95 w/Standard Key Encoding</p>  <p>Select KBD-AT</p>	<p>Set KEYBOARD WEDGE Interface Features starting on page 37</p>
 <p>Select KBD-AT-NK</p> <p>Keyboard Wedge for IBM AT PS2 with standard key encoding but without external keyboard</p>	
<p>AT, PS/2 25-286, 30-286, 50, 50Z, 60, 70, 80, 90 & 95 w/Alternate Key</p>  <p>Select KBD-AT-ALT</p>	
 <p>Select KBD-AT-ALT-NK</p> <p>Keyboard Wedge for IBM AT PS2 with alternate key encoding but without external keyboard</p>	

Customizing Configuration Settings

Configure Interface Settings

If after scanning the interface bar code from the previous table, your installation requires you to select options to further customize your reader, turn to the appropriate section for your interface type in "Configuration Parameters" starting on page 21.

Global Interface Features

See "Global Interface Features" on page 23 for settings configurable by all interface types.

Configuring Other Features

If your installation requires different programming than the standard factory default settings, the following sections of this manual allow configuration of non-interface-specific settings you might require. Go to [Configuration Using Bar Codes](#), starting on page 21 for a complete list of available options.

Software Version Transmission

The software version of the device can be transmitted over the RS-232 and Keyboard interfaces by scanning the following label.



Transmit Software Version

Resetting the Product Configuration to Defaults

Restore Custom Defaults

If you aren't sure what programming options are in your imager, or you've changed some options and want to restore the Custom Default Configuration that may have been saved in the scanner, scan the Restore Custom Default Configuration bar code below. This will restore the custom configuration for the currently active interface.



Custom defaults are based on the interface type. Configure the imager for the correct interface before scanning this label.



Restore Custom Default Configuration

Restore Factory Configuration

The "Restore Custom Default Configuration" command above is normally enough to restart the machine from a known status (set in the factory or by the customer via configuration file). The machine is set as it arrived to you from the factory or according to the custom configuration file you loaded afterward.

If you want to **permanently cancel** the setup defined by the configuration file use [Restore Factory Configuration on page 342](#) of this manual.

The programming items listed in the following sections show the factory default settings for each of the menu commands. If no configuration file has been loaded, the above command restores the factory default.

Set Date and Time

1. Scan the Enter/Exit Programming bar code below to set date and time.

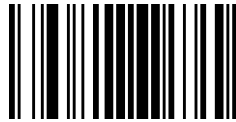

ENTER/EXIT PROGRAMMING MODE

2. Scan the Set Date bar code + six digits for Year, Month and Day (YYMMDD) from [Appendix D, Keypad](#).

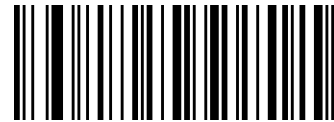

Set Date

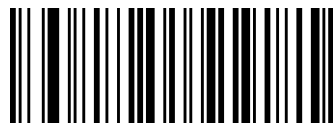

Set Time

3. Scan Set Time + six digits for Hours, Minutes and Seconds (HHMMSS) from [Appendix D, Keypad](#).

4. Scan the Enter/Exit Programming bar code to complete.

Linking the Reader

Link Datalogic RF Devices to Base

For RF devices, before configuring the interface it is necessary to link the handheld with the base.

To link the handheld and the base, press the trigger to wake up the handheld and mount it into the base. If the reader was previously linked to another base, you must first press and hold the button on the base (>5 seconds), then scan the **Unlink** bar code before re-linking to the new base.



Unlink

Linking to a Bluetooth Adapter in Serial Port Profile (Slave) Mode

1. Install any drivers provided with the Bluetooth adapter.
2. Scan the **Enable RF Link to Server** label below to make the scanner visible to the host computer.
3. Use the host computer's Bluetooth manager to "Discover new devices" and select "Datalogic Scanner." If you receive an error message, it may be necessary to disable security on the device.
4. Use an RS-232 terminal program to see incoming data on the port designated by the computer's Bluetooth manager.



Enable RF Link to Server

Linking to a Bluetooth Adapter in Serial Port Profile (Master) Mode

1. Ensure the PC or terminal can network with Bluetooth devices and that it is powered on.
2. Ensure that a COM port is assigned under Services in the Bluetooth setup menu.
3. Create a Link label that contains the address of the PC Bluetooth adapter.
The link label is a Code 128 function 3 label with the following format:
<FN3 char>LnkB<12 character Bluetooth address>
4. Scan the link label you created in step 3.



The Bluetooth address can be found under "Properties" within the Bluetooth setup menu.

Linking to a Bluetooth Adapter in HID mode

1. Install any drivers provided with the Bluetooth adapter.
2. Scan the **Link to PC in HID** label below.
3. Use the host computer's Bluetooth manager to "Discover new devices" and select "Datalogic Scanner." If you receive an error message, it may be necessary to disable security on the device.
4. Use a text editor to see incoming data on the port designated by the computer's Bluetooth manager.



Link to PC in HID



The Powerscan BT9500 can be set up to require a PIN code when connecting. If you want to set up a PIN, or when adding new equipment to a system that uses a custom security PIN, please see "[Bluetooth PIN Code](#)" starting on page 235 for more information.

Power Off

Scan the bar code below to shut off power to the handheld until the next trigger pull. This function only applies to the wireless models.



Power Off



Chapter 3

Configuration Using Bar Codes

This and following sections provide programming bar codes to configure your reader by changing the default settings. For details about additional methods of programming, see "Configuration Methods" on page 6.



You must first enable your PowerScan to read bar codes in order to use this section. If you have not done this, go to [Setup](#), starting on page 7 and complete the appropriate procedure.

Configuration Parameters

Once the reader is set up, you can change the default parameters to meet your application needs. Refer to "Standard Defaults" starting on page 329 for initial configuration in order to set the default values and select the interface for your application.

The following configuration parameters are divided into logical groups, making it easy to find the desired function based on its reference group.

Interface Configuration:

- "RS-232 Only Interface" on page 25
- "RS-232/USB-Com Interfaces" on page 29
- "Keyboard EMULATION Settings" on page 37

Parameters common to all interface applications:

- "Data Format" on page 49 gives options to control the messages sent to the Host system by selecting parameters to control the message strings sent to the handheld.
- "Reading Parameters" on page 63 control various operating modes and indicators status functioning such as programming for scanning, beeper and LED indicators and other universal settings.

Wireless-Only Features

- Wireless Features, starting on page 213:
- PBT9300-Only Features, starting on page 234
- PM9300-Only Features, starting on page 247
- Display and Keyboard Features, starting on page 252

Symbology-specific parameters:

The Chapter Symbologies on page 75, provides configuration of a personalized mix of 1D codes, code families and their options.



You must first enable your reader to read bar codes in order to use this section. If you have not done this, go to [Setup](#), starting on page 7 and complete the appropriate procedure.

To program features:

1. Scan the ENTER/EXIT PROGRAMMING bar code, available at the top of each programming page, when applicable.
2. Scan the bar code to set the desired programming feature. You may need to cover unused bar codes on the page, and possibly the facing page, to ensure that the reader reads only the bar code you intend to scan.
3. If additional input parameters are needed, go to [Appendix D, Keypad](#), and scan the appropriate characters from the keypad.



Additional information about many features can be found in the "References" chapter.

If you make a mistake before the last character, scan the CANCEL bar code to abort and not save the entry string. You can then start again at the beginning.

4. Complete the programming sequence by scanning the ENTER/EXIT PROGRAMMING bar code to exit Programming Mode.

For more detailed descriptions, programming information and examples for setting selected configuration items, see [References](#), starting on page 285.



GLOBAL INTERFACE FEATURES

The following interface features are configurable by all interface types.

Host Commands — Obey/Ignore

This option specifies whether the reader will obey or ignore host commands. When set to ignore, the reader will ignore all host commands except those necessary for:

- service mode
- flash programming mode
- keeping the interface active
- transmission of labels.

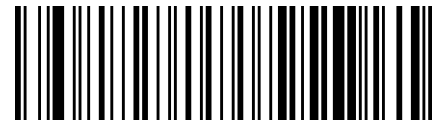

Host Commands = Obey
(Do Not Ignore Host Commands)



Host Commands = Ignore

NOTES

RS-232 ONLY INTERFACE

BAUD RATE on page 26
STOP BITS on page 27
PARITY on page 27
HANDSHAKING CONTROL on page 28

Use the programming bar codes in this section if modifications to the standard RS-232 interface settings are necessary to meet your system's requirements. Additional settings which apply to both the RS-232 and USB interfaces are available in the next section, "[RS-232/USB-Com Interfaces](#)" starting on page 29.

Reference [Appendix C, Standard Defaults](#) for a listing of standard factory settings.



Baud Rate

See page 286 for information on this feature.



Baud Rate = 1200

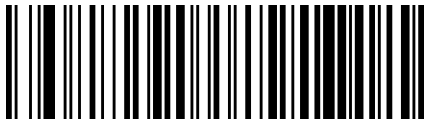

Baud Rate = 2400

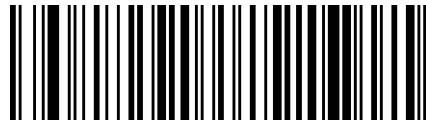

Baud Rate = 4800

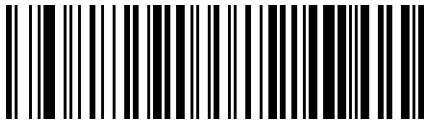

Baud Rate = 9600

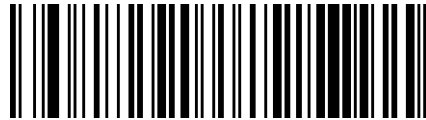

Baud Rate = 19,200

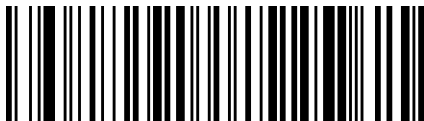

Baud Rate = 38,400



Baud Rate = 57,600



Baud Rate = 115,200





Stop Bits

Set the number of stop bits to match host device requirements. See [page 286](#) for more information on this feature.

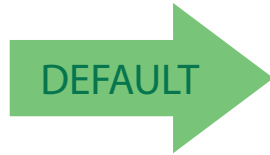

1 Stop Bit

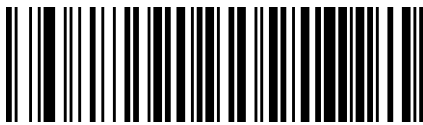

2 Stop Bits

Parity

This feature specifies parity required for sending and receiving data. Select the parity type according to host device requirements. See [page 286](#) for more information.

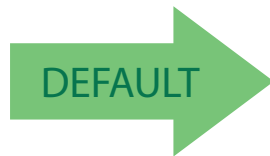

Parity = None



Parity = Even



Parity = Odd



Handshaking Control

See page 286 for more information about this feature.

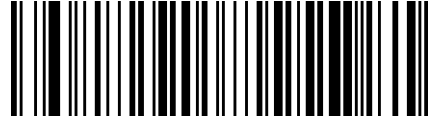
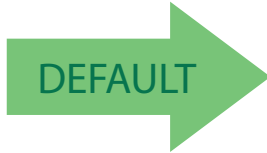

Handshaking Control = RTS

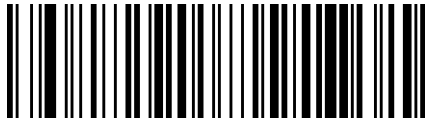

Handshaking Control = RTS/CTS

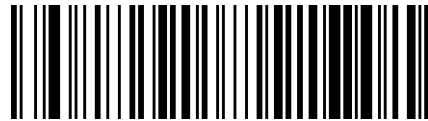

Handshaking Control = RTS/XON/XOFF



Handshaking Control = RTS On/CTS



Handshaking Control = RTS/CTS Scan Control

RS-232/USB-COM INTERFACES

INTERCHARACTER DELAY on page 30
BEEP ON ASCII BEL on page 30
BEEP ON NOT ON FILE on page 31
ACK NAK OPTIONS on page 31
ACK CHARACTER on page 32
NAK CHARACTER on page 32
ACK NAK TIMEOUT VALUE on page 33
ACK NAK RETRY COUNT on page 33
ACK NAK ERROR HANDLING on page 34
INDICATE TRANSMISSION FAILURE on page 34
DISABLE CHARACTER on page 35
ENABLE CHARACTER on page 35

The programming bar codes in this chapter allow modifications to the standard RS-232 and USB-Com interfaces. Reference [Appendix C, Standard Defaults](#) for a listing of standard factory settings.



Intercharacter Delay

This parameter specifies the intercharacter delay between the end of one character and the beginning of the next. The delay can be set within a range of zero (0) to 990 milliseconds in 10ms increments. A setting of zero specifies no delay.

See [page 295](#) for more information.



Intercharacter Delay = No Delay

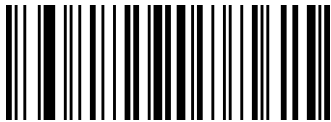

Select Intercharacter Delay Setting

To configure this feature, scan the ENTER/EXIT PROGRAMMING MODE bar code above, then the bar code at left followed by the digits from the Alphanumeric characters in [Appendix D, Keypad](#) representing your desired character(s). End by scanning the ENTER/EXIT bar code twice.

Make a mistake? Scan the CANCEL bar code to abort and not save the entry string. You can then start again at the beginning.

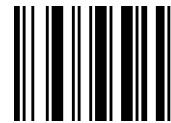

CANCEL



00 = No Intercharacter Delay

Beep On ASCII BEL

When this parameter is enabled, the reader issues a beep when a <BEL> character is detected on the RS-232 serial line. <BEL> is issued to gain a user's attention to an illegal entry or other important event.



Beep On ASCII BEL = Disable



Beep On ASCII BEL = Enable



Beep On Not on File

This option enables/disables the action of the reader to sound a three beep sequence upon receiving a Not-On-File (NOF) host command.

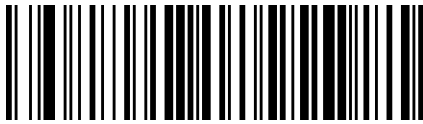

Beep On Not On File = Disable

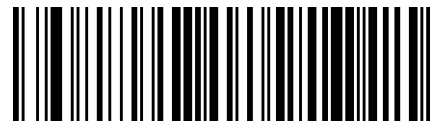
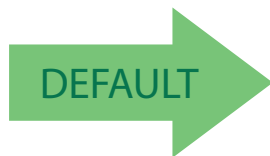

Beep On Not On File = Enable

ACK NAK Options

This enables/disables the ability of the reader to support the RS-232 ACK/NAK protocol.
See [page 288](#) for more information.

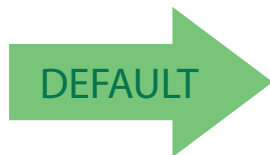

ACK/NAK Protocol = Disable ACK/NAK

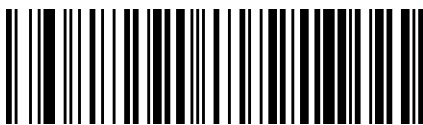

ACK/NAK Protocol = Enable for label transmission



ACK/NAK Protocol = Enable for host-command
acknowledge



ACK/NAK Protocol = Enable for label transmission and
host-command acknowledge



ACK Character

This setting specifies an ASCII character or hex value to be used as the ACK character. ASCII characters or any hex value from 0 to 0xFF can be selected. See [page 288](#) for more information.

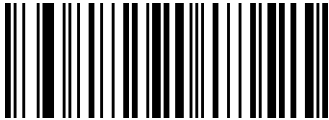

Select ACK Character Setting

To configure this feature, scan the ENTER/EXIT PROGRAMMING MODE bar code above, then the bar code at left followed by the digits from the Alphanumeric characters in [Appendix D, Keypad](#) representing your desired character(s). End by scanning the ENTER/EXIT bar code twice.

Make a mistake? Scan the CANCEL bar code to abort and not save the entry string. You can then start again at the beginning.

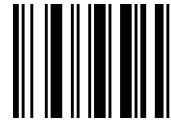

CANCEL

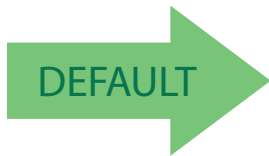

0x06 'ACK' Character

NAK Character

This setting specifies an ASCII character or hex value to be used as the NAK character. ASCII characters or any hex value from 0 to 0xFF can be selected. See [page 289](#) for more information.

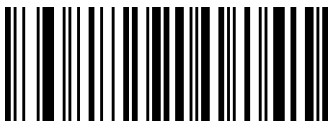

Select NAK Character Setting

To configure this feature, scan the ENTER/EXIT PROGRAMMING MODE bar code above, then the bar code at left followed by the digits from the Alphanumeric characters in [Appendix D, Keypad](#) representing your desired character(s). End by scanning the ENTER/EXIT bar code twice.

Make a mistake? Scan the CANCEL bar code to abort and not save the entry string. You can then start again at the beginning.



CANCEL

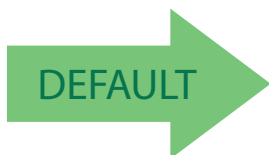

0x15 'NAK' Character



ACK NAK Timeout Value

This option specifies the amount of time the reader waits for an ACK character from the host following label transmission. The selectable timeout range is 200 milliseconds to 15,000ms (15 seconds) in 200ms increments. A selection of 0 disables the timeout.

See [page 290](#) for more information on setting this feature.



Select ACK NAK Timeout Value Setting

To configure this feature, scan the ENTER/EXIT PROGRAMMING MODE bar code above, then the bar code at left followed by the digits from the Alphanumeric characters in [Appendix D, Keypad](#) representing your desired character(s). End by scanning the ENTER/EXIT bar code twice.

Make a mistake? Scan the CANCEL bar code to abort and not save the entry string. You can then start again at the beginning.



CANCEL

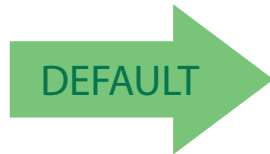

01 ACK NAK Timeout value is 200ms

ACK NAK Retry Count

This feature specifies the number of times the reader retries a label transmission due to a retry condition. The selectable range is from 1 to 254 retries. A selection of 0 disables the count, and a selection of 255 specifies unlimited retries. See [page 291](#) for more information.



Select ACK NAK Retry Count Setting

To configure this feature, scan the ENTER/EXIT PROGRAMMING MODE bar code above, then the bar code at left followed by the digits from the Alphanumeric characters in [Appendix D, Keypad](#) representing your desired character(s). End by scanning the ENTER/EXIT bar code twice.

Make a mistake? Scan the CANCEL bar code to abort and not save the entry string. You can then start again at the beginning.



CANCEL



003 = 3 Retries



ACK NAK Error Handling

This feature specifies the method the reader uses to handle receive errors detected while waiting for an ACK character from the host.

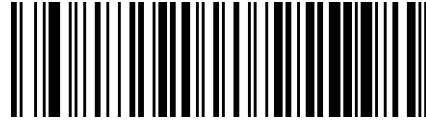
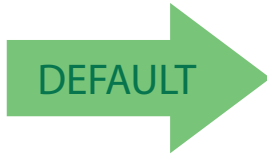

ACK NAK Error Handling = Ignore Errors Detected

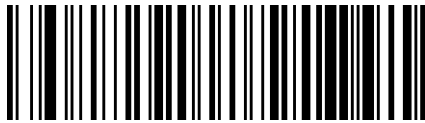

ACK NAK Error Handling = Process Error as Valid ACK Character

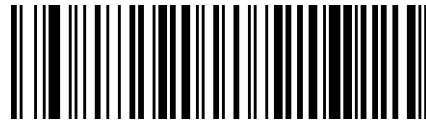

ACK NAK Error Handling = Process Error as Valid NAK Character

Indicate Transmission Failure

This option enables/disables the reader's ability to sound an error beep to indicate a transmission failure while in ACK/NAK mode.



Indicate Transmission Failure = Disable Indication



Indicate Transmission Failure = Enable Indication





Disable Character

Specifies the value of the RS-232 host command used to disable the reader. ASCII characters or any hex value from 0 to 0xFF can be selected. See [page 292](#) for more information on setting this feature.

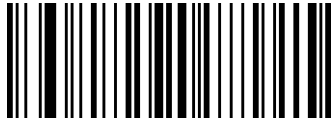

Select Disable Character Setting

To configure this feature, scan the ENTER/EXIT PROGRAMMING MODE bar code above, then the bar code at left followed by the digits from the Alphanumeric characters in [Appendix D, Keypad](#) representing your desired character(s). End by scanning the ENTER/EXIT bar code twice.

Make a mistake? Scan the CANCEL bar code to abort and not save the entry string. You can then start again at the beginning.

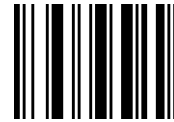

CANCEL

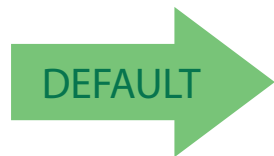

0x44 = Disable Character is 'D'

Enable Character

Specifies the value of the RS-232 host command used to enable the reader. ASCII characters or any hex value from 0 to 0xFF can be selected. See [page 293](#) in “References” for more information on setting this feature.

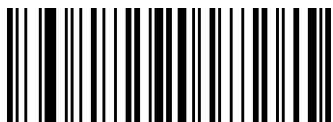

Select Enable Character Setting

To configure this feature, scan the ENTER/EXIT PROGRAMMING MODE bar code above, then the bar code at left followed by the digits from the Alphanumeric characters in [Appendix D, Keypad](#) representing your desired character(s). End by scanning the ENTER/EXIT bar code twice.

Make a mistake? Scan the CANCEL bar code to abort and not save the entry string. You can then start again at the beginning.



CANCEL

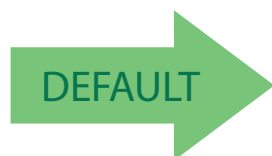

0x45 = Enable Character is 'E'

NOTES

KEYBOARD EMULATION SETTINGS

COUNTRY MODE on page 38
SEND CONTROL CHARACTERS on page 41
WEDGE QUIET INTERVAL on page 42
INTERCODE DELAY on page 42
CAPS LOCK STATE on page 43
NUMLOCK on page 43
USB KEYBOARD SPEED on page 44
USB KEYBOARD NUMERIC KEYPAD on page 45

Use the programming bar codes in this chapter to select options for USB Keyboard and Wedge Interfaces. Reference [Appendix C, Standard Defaults](#) for a listing of standard factory settings.

Information about control character emulation which applies to keyboard interfaces is listed in [Appendix E, Scancode Tables](#).



Country Mode

This feature specifies the country/language supported by the keyboard. Several languages are supported:

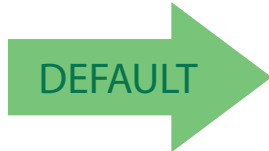

Country Mode = U.S.

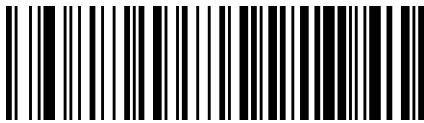

Country Mode = Belgium

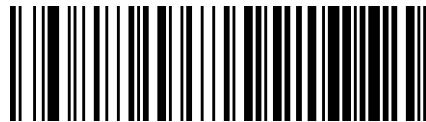

Country Mode = Britain

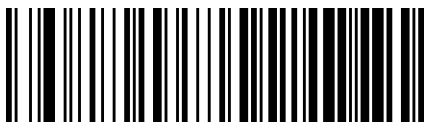

Country Mode = Denmark



Country Mode = France



Country Mode = Germany



Country Mode = Italy



Country Mode (continued)

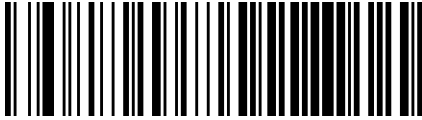

Country Mode = Norway



Country Mode = Portugal

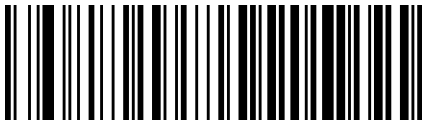

Country Mode = Spain



Country Mode = Sweden



Country Mode = Switzerland



Country Mode = Japanese 106-key



Country Mode = Hungary



Enter/Exit Programming Mode

Country Mode (continued)



Country Mode = Czech Republic

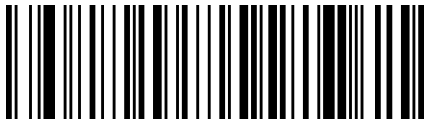

Country Mode = Slovakia



Country Mode = Romania

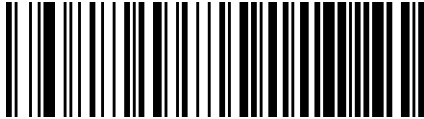

Country Mode = Croatia



Country Mode = Poland

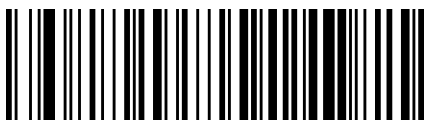

Country Mode = French Canadian



Country Mode = Lithuanian



Send Control Characters

This feature specifies how the reader transmits ASCII control characters to the host. Reference [Appendix E, Scancode Tables](#) for more information about control characters.

Options are as follows:

Control Character 00 : Characters from 00 to 0x1F are sent as control character Ctrl+Keys, special keys are located from 0x80 to 0xA1.

Control Character 01 : Characters from 00 to 0x1F are sent as control character Ctrl+Shift, special keys are located from 0x80 to 0xA1.

Control Character 02 : Special keys are located from 00 to 0x1F and characters from 0x80 to 0xFE are intended as an extended ASCII table.

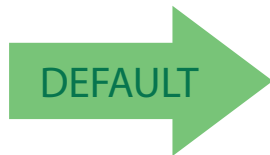

Wedge Send Control Characters = 00

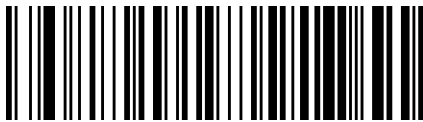

Wedge Send Control Characters = 01



Wedge Send Control Characters = 02



Wedge Quiet Interval

Specifies amount of time to look for keyboard activity before scanner breaks keyboard connection in order to transmit data to host. The selectable range for this setting is 00 to 990 milliseconds (00–0x63 by 01) in increments of ten milliseconds. See [page 294](#) in “References” for detailed information and examples for setting this feature.



Set Wedge Quiet Interval

To configure this feature, scan the ENTER/EXIT PROGRAMMING MODE bar code above, then the bar code at left followed by the digits from the Alphanumeric characters in [Appendix D, Keypad](#) representing your desired character(s). End by scanning the ENTER/EXIT bar code twice.

Make a mistake? Scan the CANCEL bar code to abort and not save the entry string. You can then start again at the beginning.

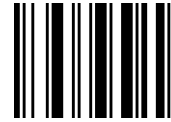

CANCEL

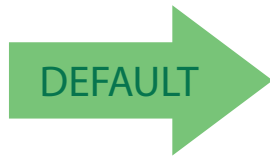

0A = Quiet Interval is 100 milliseconds

Intercode Delay

Specifies the delay between labels transmitted to the host for this interface. The selectable range for this feature is from 0 to 99 seconds.

See [page 296](#) in “References” for detailed information and examples for setting this feature.



Set Intercode Delay

To configure this feature, scan the ENTER/EXIT PROGRAMMING MODE bar code above, then the bar code at left followed by the digits from the Alphanumeric characters in [Appendix D, Keypad](#) representing your desired character(s). End by scanning the ENTER/EXIT bar code twice.

Make a mistake? Scan the CANCEL bar code to abort and not save the entry string. You can then start again at the beginning.



CANCEL

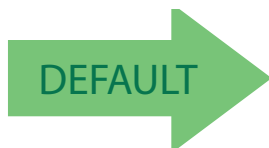

00 = No Wedge Intercode Delay



Caps Lock State

This option specifies the format in which the reader sends character data. This does not apply when an alternate key encoding keyboard is selected.

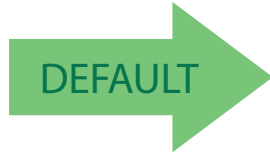

Caps Lock State = Caps Lock OFF

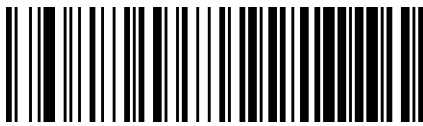

Caps Lock State = Caps Lock ON

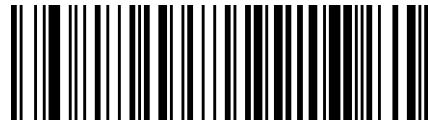

Caps Lock State = AUTO Caps Lock Enable

Numlock

This option specifies the setting of the NUMLOCK key in the Keyboard Wedge interface.

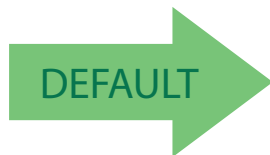

Numlock = NUMLOCK key unchanged



Numlock = Numlock key toggled



USB Keyboard Speed

This option specifies the USB poll rate for a USB keyboard.



This feature applies **ONLY** to the USB Keyboard interface.

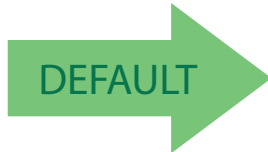

USB Keyboard Speed = 1ms

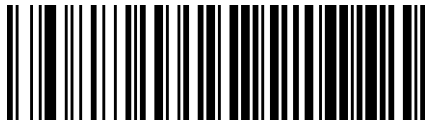

USB Keyboard Speed = 2ms



USB Keyboard Speed = 3ms



USB Keyboard Speed = 4ms



USB Keyboard Speed = 5ms



USB Keyboard Speed = 6ms



USB Keyboard Speed (continued)



USB Keyboard Speed = 7ms

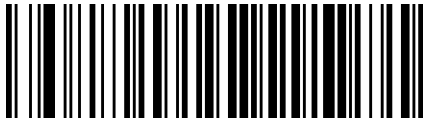

USB Keyboard Speed = 8ms



USB Keyboard Speed = 9ms



USB Keyboard Speed = 10ms

USB Keyboard Numeric Keypad

This option Controls whether numeric characters will be sent using standard keys or the numeric keypad.

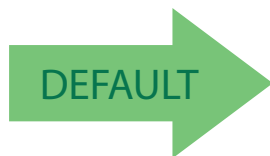

Standard Keys



Numeric Keypad

NOTES

USB-OEM INTERFACE

USB-OEM DEVICE USAGE on page 48

INTERFACE OPTIONS on page 48

Feature settings for USB interfaces differ depending upon which host type the reader will be connected with. Use the feature settings in this chapter to specifically configure for the USB-OEM interface. Other USB interfaces are included in the appropriate chapter for their host type.

Reference [Appendix C](#) for a listing of standard factory settings.

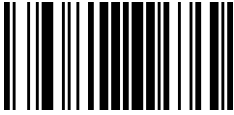

USB-OEM Device Usage

The USB-OEM protocol allows for the reader to be identified as one of two different types of bar code scanners. Depending on what other scanners you may already have connected to a USB-OEM POS, you may need to change this setting to enable all devices to communicate.

Options are:

- Table Top Scanner
- Handheld Scanner



It may be necessary to switch device usage when connecting two readers/scanners of the same type to a POS system.

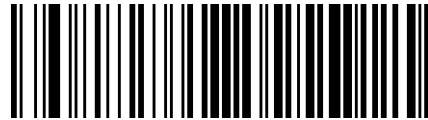

USB-OEM Device Usage = Table Top Scanner

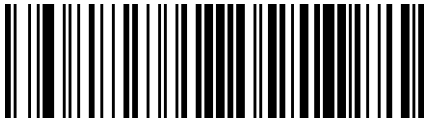

USB-OEM Device Usage = Handheld Scanner



Interface Options

This feature provides for an interface-specific control mechanism.



Obey Scanner Configuration Host Commands



Ignore Scanner Configuration Host Commands



DATA FORMAT

GLOBAL PREFIX/SUFFIX (HEADER/TERMINATOR) on page 50
GLOBAL AIM ID on page 51
SET AIM ID INDIVIDUALLY FOR GS1-128 on page 53
LABEL ID: PRE-LOADED SETS on page 54
LABEL ID CONTROL on page 55
LABEL ID SYMBOLOGY SELECTION on page 56
CASE CONVERSION on page 61
CHARACTER CONVERSION on page 62

The features in this chapter can be used to build specific user-defined data into a message string. See “References” starting on page 285 for more detailed instructions on setting these features.



Global Prefix/Suffix (Header/Terminator)

This option sets up to 20 characters each from the set of ASCII characters or any hex value from 00 to FF. The characters may be added as a prefix (in a position before the bar code data, also called a header) and/or as a suffix (in a position following the bar code data, also called a terminator). See [page 300](#) for more detailed instructions on setting this feature.

To configure this feature, scan the ENTER/EXIT PROGRAMMING MODE bar code above to place the unit in Programming Mode, then the “Set Global Prefix” or “Set Global Suffix,” bar code followed by the digits (in hex) from the Alphanumeric characters in [Appendix D Keypad](#) representing your desired character(s). If less than the expected string of 20 characters are selected, scan the ENTER/EXIT bar code to terminate the string. Exit programming mode by scanning the ENTER/EXIT bar code twice.

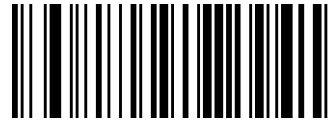

Set Global Prefix

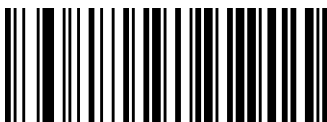

Set Global Suffix

Make a mistake? Scan the CANCEL bar code to abort and not save the entry string. You can then start again at the beginning.



CANCEL

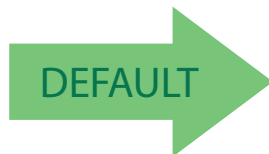

No Global Prefix
Global Suffix = 0x0D (CR)



Global AIM ID



This feature enables/disables addition of AIM IDs for all symbology types.

AIM label identifiers (as opposed to custom characters you select yourself as with label identifiers) can be included with scanned bar code data. See the following table for a listing of AIM IDs.

AIM label identifiers consist of three characters as follows:

- A close brace character (ASCII ‘]’), followed by...
- A code character (see some samples in the table below), followed by...
- A modifier character (the modifier character is symbol dependent).

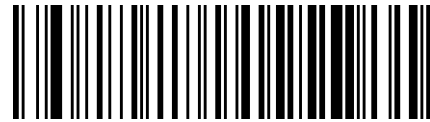
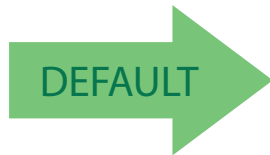

Global AIM ID = Disable



Global AIM ID = Enable

Table 3. AIM IDs

Tag Name	AIM ID code character	AIM ID code ASCII value
AZTEC	z	7A
CHINA SENSIBLE CODE	X	58
CODABAR	F	46
CODE11	H	48
CODE128	C	43
CODE32	A	41
CODE39	A	41
CODE39 CIP	X	58
CODE93	G	47
DATABAR 14	e	65
DATABAR 14 COMPOSITE	e	65



AIM IDs (continued)		
DATABAR EXPANDED	e	65
DATABAR EXPANDED COMPOSITE	e	65
DATABAR LIMITED	e	65
DATABAR LIMITED COMPOSITE	e	65
EAN128	C	43
EAN128 COMPOSITE	C	43
EAN13	E	45
EAN13 P2	E	45
EAN13 P5	E	45
EAN13 COMPOSITE	E	45
EAN8	E	45
EAN8 P2	E	45
EAN8 P5	E	45
EAN8 COMPOSITE	E	45
FOLLET 2OF5	X	58
I2OF5	I	49
IATA INDUSTRIAL 2OF5 (Only standard optic models)	X	58
INDUSTRIAL 2OF5	X	58
ISBN	X	58
ISBT128 CONCAT	X	58
ISSN	X	58
MSI	M	4D
PLESSEY (Only standard optic models)	P	50
S25	S	53
TRIOPTIC	X	58
UPCA	E	45

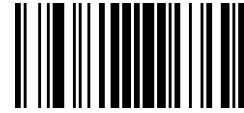

AIM IDs (continued)		
UPCA P2	E	45
UPCA P5	E	45
UPCA COMPOSITE	E	45
UPCE	E	45
UPCE P2	E	45
UPCE P5	E	45
UPCE COMPOSITE	E	45

Set AIM ID Individually for GS1-128

This feature configures a Label ID individually for the GS1-128 symbology and the programming for this works the same way as Label ID. See [Label ID: Set Individually Per Symbology, starting on page 304](#) for detailed instructions on setting this feature.



Set AIM ID Individually for GS1-128 = Disable



Set AIM ID Individually for GS1-128 = Enable





LABEL ID

A Label ID is a customizable code of up to three ASCII characters (convert to Hex using the ASCII Chart on the inside back cover of this manual), used to identify a bar code symbology type. It can be appended previous to or following the transmitted bar code data depending upon how this option is enabled. This feature provides options for configuring custom Label IDs or individually per symbology (see "Individually Set Label ID" on page 55). If you wish to program the reader to always include an industry standard label identifier for ALL symbology types, see the previous feature "Global AIM ID" on page 51.

See [Label ID, starting on page 302](#) of "References" for more information on setting this feature.

Label ID: Pre-Loaded Sets

The reader supports two pre-loaded sets of Label IDs. See [Label ID: Pre-loaded Sets, starting on page 302](#) for details on the USA set and EU set.



CAUTION

When changing from one Label ID set to another, all other reader configuration settings, including the host interface type, will be erased and set to the standard factory defaults. Any custom configuration or custom defaults will be lost.

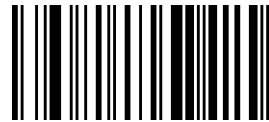

Label ID Pre-loaded Set = USA Set



Label ID Pre-loaded Set = EU Set





INDIVIDUALLY SET LABEL ID

This feature configures a Label ID individually for a single symbology. To set, first define whether you want it as a prefix or suffix by scanning a label below. Then turn to [Label ID Symbology Selection, starting on page 56](#) to select the symbology you want to set, followed by up to 3 characters from the ASCII Chart at the back of this manual. See "[Label ID: Set Individually Per Symbology](#)" on page 304 for detailed instructions on setting this feature.

Label ID Control

This option controls whether a Label ID is disabled, or sent as a prefix or suffix for a given symbology type.

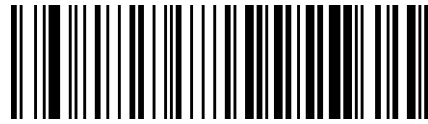
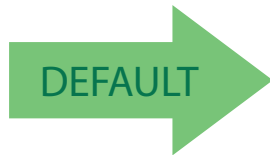

Label ID Transmission = Disable

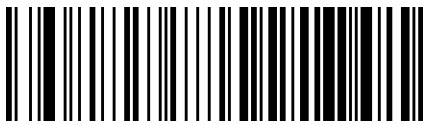

Label ID Transmission = Enable as Prefix

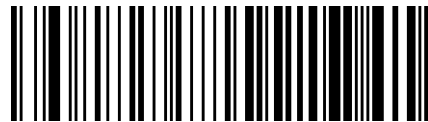

Label ID Transmission = Enable as Suffix



CANCEL

Make a mistake? Scan the CANCEL bar code to abort and not save the entry string. You can then start again at the beginning.



Label ID Symbology Selection

This option selects the symbology for which a Label ID is to be configured. See "Label ID" on page 54 or page 304 in "References" for more detailed instructions.



If less than the expected string of 3 characters are selected, scan the ENTER/EXIT bar code twice to accept the selection and exit Programming Mode.

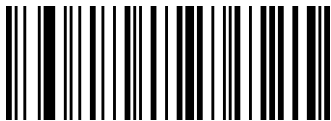

Set Anker Plessey Label ID Character(s)
(Only standard optic models)

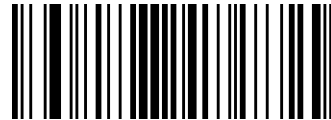

Set Code 32 Pharmacode Label ID Character(s)

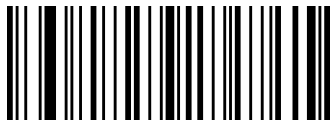

Set Concatenated ISBT 128 Label ID Character(s)



Set Code 93 Label ID Character(s)

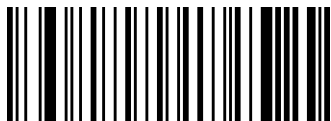

Set Codabar Label ID Character(s)



Set EAN 13 Label ID Character(s)



Set Code 11 Label ID Character(s)
(Only standard optic models)

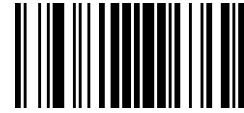

Enter/Exit Programming Mode

Label ID Symbology Selection (continued)



Set EAN 13 Composite Label ID Character(s)

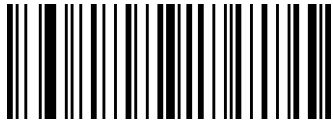

Set Code 128 Label ID Character(s)



Set EAN 13 / P2 Label ID Character(s)

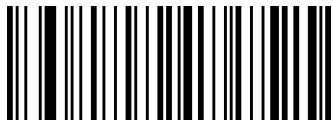

Set Code 39 Label ID Character(s)



Set EAN 13 / P5 Label ID Character(s)



Set Code 39 CIP Label ID Character(s)

(Only standard optic models)

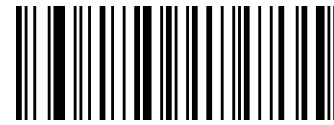

Set GS1 DataBar Expanded Composite
Label ID Character(s)



Set GS1-128 Label ID Character(s)



Label ID Symbology Selection (continued)

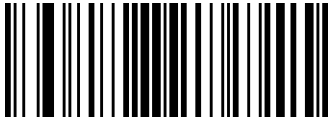

Set GS1-128 Composite Label ID Character(s)

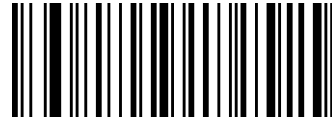

Set GS1 DataBar Limited Label ID Character(s)



Set Follett 2 of 5 Label ID Character(s)
(Only standard optic models)



Set GS1 DataBar Limited Composite Label ID Character(s)

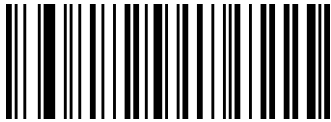

Set GS1 DataBar 14 Label ID Character(s)



Set GTIN 2 Label ID Character(s)

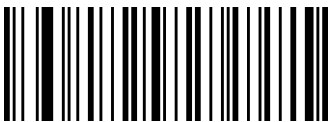

Set GS1 DataBar 14 Composite Label ID Character(s)

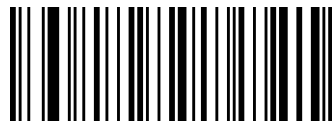

Set GTIN / P5 Label ID Character(s)



Label ID Symbology Selection (continued)

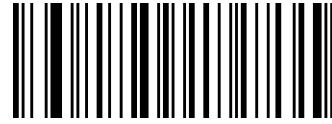

Set GS1 DataBar Expanded Label ID Character(s)

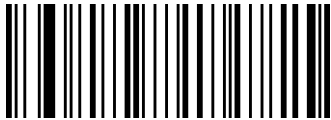

Set GTIN 8 Label ID Character(s)



Set IATA Industrial 2 of 5 Label ID Character(s)
(Only standard optic models)

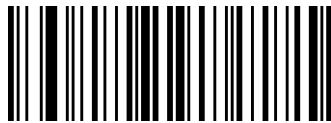

Set MSI Label ID Character(s)

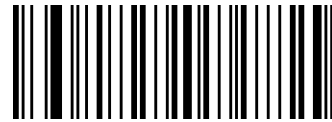

Set Interleaved 2 of 5 Label ID Character(s)

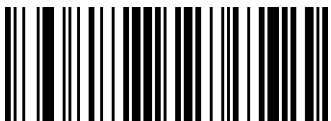

Set Plessey Label ID Character(s)
(Only standard optic models)

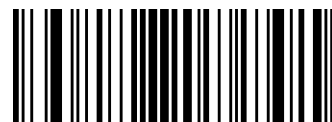

Set Industrial 2 of 5 Label ID Character(s)
(Only standard optic models)

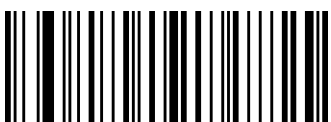

Set UPC-A Composite Label ID Character(s)



Label ID Symbology Selection (continued)



Set UPC-A / P2 Label ID Character(s)



Set Standard 2 of 5 Label ID Character(s)



Set UPC-A P5 Label ID Character(s)



Set UPC-E Label ID Character(s)

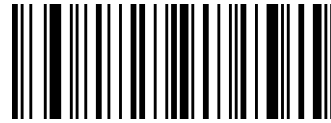

Set ISBN Label ID Character(s)

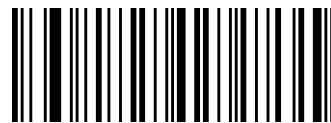

Set ISSN Label ID Character(s)



Set UPC-A Label ID Character(s)



Set UPC-E P5 Label ID Character(s)

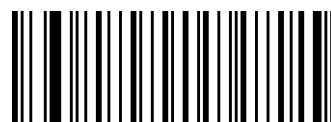

Set Codablock F Label ID Character(s)
(Only standard optic models)



ADVANCED FORMATTING: USER LABEL EDIT

Advanced formatting is available to create user label edit scripts. See the Datalogic Aladdin configuration application or contact Technical Support.

Case Conversion

This feature allows conversion of the case of all alphabetic characters to upper or lower case.



Case conversion affects **ONLY** scanned bar code data, and does not affect Label ID, Prefix, Suffix, or other appended data.

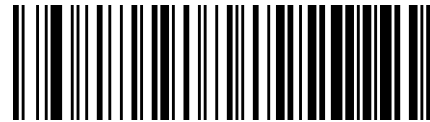
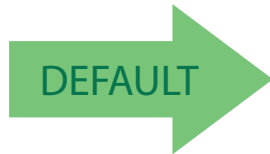

Case Conversion = Disable (no case conversion)



Case Conversion = Convert to upper case



Case Conversion = Convert to lower case



Character Conversion

Character conversion is an eight byte configuration item. The eight bytes are 4 character pairs represented in hexadecimal ASCII values. The first character in the pair is the character that will be converted. The second character in the pair is the character to convert to. If the character to convert in a pair is FF, then no conversion is done.



If less than the expected string of 16 characters are selected, scan the ENTER/EXIT bar code twice to accept the selections and exit Programming Mode.

To configure this feature, scan the ENTER/EXIT PROGRAMMING MODE bar code above, then the bar code at left followed by the digits from the Alphanumeric characters in [Appendix D Keypad](#) representing your desired character(s). End by scanning the ENTER/EXIT bar code twice.

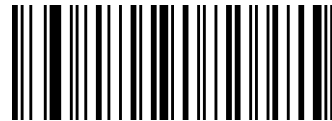

Configure Character Conversion

Make a mistake? Scan the CANCEL bar code to abort and not save the entry string. You can then start again at the beginning.



CANCEL

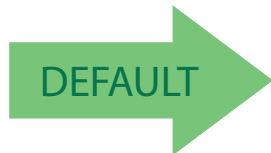

OxFFFFFFFFFFFFFFF
(No character conversion)

READING PARAMETERS

DOUBLE READ TIMEOUT on page 64
POWER ON ALERT on page 66
GOOD READ: WHEN TO INDICATE on page 66
GOOD READ BEEP TYPE on page 67
GOOD READ BEEP FREQUENCY on page 67
GOOD READ BEEP LENGTH on page 68
GOOD READ BEEP VOLUME on page 69
GOOD READ LED DURATION on page 70
SCAN MODE on page 71
SCANNING ACTIVE TIME on page 72
FLASH ON TIME on page 72
FLASH OFF TIME on page 73
AIMING POINTER on page 73
GREEN SPOT DURATION on page 74



Double Read Timeout

Double Read Timeout prevents a double read of the same label by setting the minimum time allowed between reads of labels of the same symbology and data. If the unit reads a label and sees the same label again within the specified timeout, the second read is ignored. Double Read Timeout does not apply to scan modes that require a trigger pull for each label read.

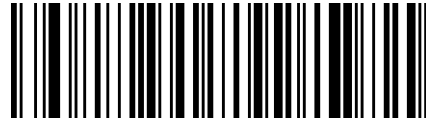

Double Read Timeout = 0.1 Second



Double Read Timeout = 0.2 Second



Double Read Timeout = 0.3 Second



Double Read Timeout = 0.4 Second



Double Read Timeout = 0.5 Second



Double Read Timeout = 0.6 Second



Double Read Timeout = 0.7 Second



Double Read Timeout (continued)



Double Read Timeout = 0.8 Second



Double Read Timeout = 0.9 Second



Double Read Timeout = 1 Second



LED AND BEEPER INDICATORS

Power On Alert

Disables or enables the indication (from the Beeper) that the reader is receiving power.

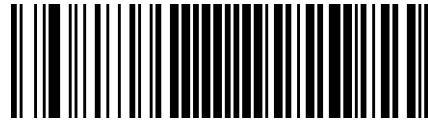

Power On Alert = Disable (No Audible Indication)



Power On Alert = Power-up Beep



Good Read: When to Indicate

This feature specifies when the reader will provide indication (beep and/or flash its green LED) upon successfully reading a bar code.

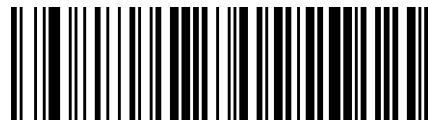
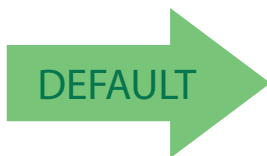

Indicate Good Read = After Decode

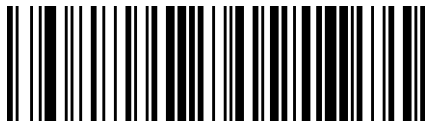

Indicate Good Read = After Transmit



Indicate Good Read =
After CTS goes inactive then active



Good Read Beep Type

Specifies whether the good read beep has a mono or bitonal beep sound.

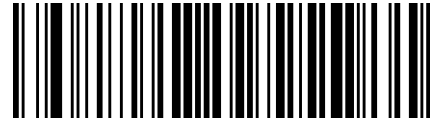
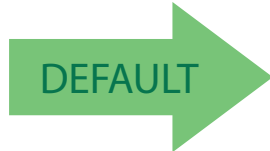

Good Read Beep Type = Mono



Good Read Beep Type = Bitonal

Good Read Beep Frequency

Adjusts the good read beep to sound at a selectable low, medium or high frequency, selectable from the list below. (Controls the beeper's pitch/ tone.)



Good Read Beep Frequency = Low



Good Read Beep Frequency = Medium

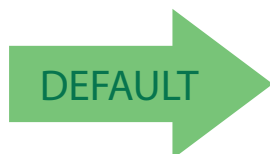

Good Read Beep Frequency = High



Good Read Beep Length



Good Read Beep Length = 60 msec



Good Read Beep Length = 80 msec

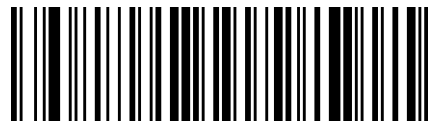

Good Read Beep Length = 100 msec



Good Read Beep Length = 120 msec

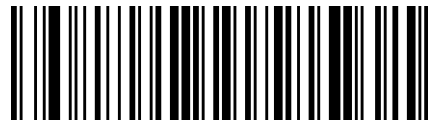

Good Read Beep Length = 140 msec



Good Read Beep Length = 160 msec



Good Read Beep Length = 180 msec



Good Read Beep Length = 200 msec

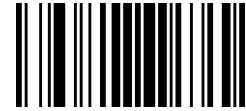

Good Read Beep Volume

Selects the beeper volume (loudness) upon a good read beep. There are three selectable volume levels.



Good Read Beep Volume = Beeper Off



Good Read Beep Volume = Low



Good Read Beep Volume = Medium



Good Read Beep Volume = High





Good Read LED Duration

This feature specifies the amount of time that the Good Read LED remains on following a good read. The good read LED on time can be set within a range of 100 milliseconds to 25,500 milliseconds (0.1 to 25.5 seconds) in 100ms increments. A setting of 00 keeps the LED on until the next trigger pull.

See [page 307](#) in “References” for detailed instructions and examples for setting this feature.



Good Read LED Duration Setting =
Keep LED on until next trigger pull

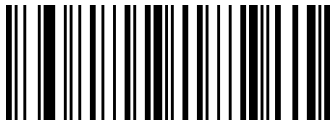

Select Good Read LED Duration Setting

To configure this feature, scan the ENTER/EXIT PROGRAMMING MODE bar code above, then the bar code at left followed by the digits from the Alphanumeric characters in [Appendix D, Keypad](#) representing your desired character(s). End by scanning the ENTER/EXIT bar code twice.

Make a mistake? Scan the CANCEL bar code to abort and not save the entry string. You can then start again at the beginning.

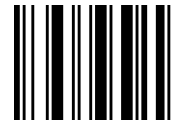

CANCEL



003 = Good Read LED stays on for 300 ms.



Indicators are dimmed during sleep.



SCANNING FEATURES

Scan Mode

Selects the reader's scan operating mode. See [page 308](#) in "References" for descriptions.

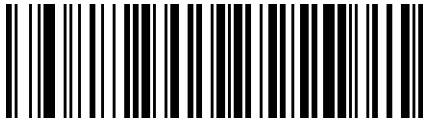

Scan Mode = Trigger Single



Scan Mode = Trigger Hold Multiple

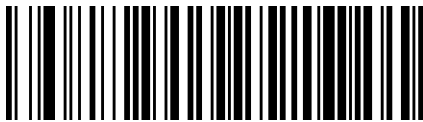

Scan Mode = Trigger Pulse Multiple



Scan Mode = Flashing



Scan Mode = Always On



Scanning Active Time

This setting specifies the amount of time that the reader stays in scan ON state once the state is entered. The range for this setting is from 1 to 255 seconds in 1-second increments. See page 308 in “References” for further description of this feature.



Scanning Active Time = 3 seconds



Scanning Active Time = 5 seconds



Scanning Active Time = 8 seconds

Flash On Time

This feature specifies the ON time for the indicator LED while in Flash Mode. The selectable range is 100 to 9,900 milliseconds (0.1 to 9.9 seconds), in 100 millisecond increments. See page 308 in “References” for further description of this feature.

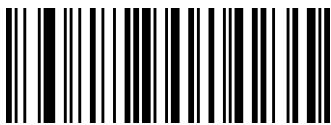

Select Flash ON Time Setting

To configure this feature, scan the ENTER/EXIT PROGRAMMING MODE bar code above, then the bar code at left followed by the digits from the Alphanumeric characters in Appendix D, Keypad representing your desired character(s). End by scanning the ENTER/EXIT bar code twice.

Make a mistake? Scan the CANCEL bar code to abort and not save the entry string. You can then start again at the beginning.



CANCEL

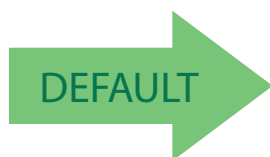

10 = Flash is ON for 1 Second



Enter/Exit Programming Mode

Flash Off Time

This feature specifies the OFF time for the indicator LED while in Flash Mode. The selectable range is 100 to 9,900 milliseconds (0.1 to 9.9 seconds), in 100 millisecond increments. See [page 308](#) in “References” for further description of this feature.



Select Flash OFF Time Setting

To configure this feature, scan the ENTER/EXIT PROGRAMMING MODE bar code above, then the bar code at left followed by the digits from the Alphanumeric characters in [Appendix D, Keypad](#) representing your desired character(s). End by scanning the ENTER/EXIT bar code twice.

Make a mistake? Scan the CANCEL bar code to abort and not save the entry string. You can then start again at the beginning.

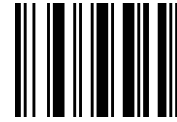

CANCEL

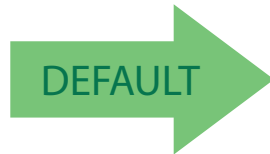

06 = Flash is OFF for 600ms

Aiming Pointer

Enables/disables the aiming pointer for all symbologies.

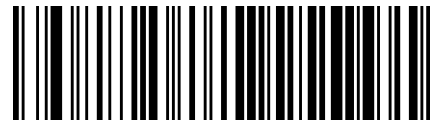

Aiming Pointer = Disable



Aiming Pointer = Enable





Green Spot Duration

Specifies the duration of the good read pointer beam after a good read.



Green Spot Duration = Disable (Green Spot is Off)

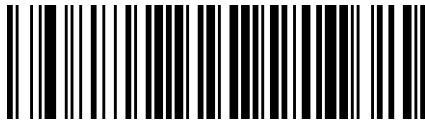

Green Spot Duration = Short (300 msec)



Green Spot Duration = Medium (500 msec)



Green Spot Duration = Long (800 msec)

SYMBOLOGIES

The scanner supports the following symbologies (bar code types). Symbology-dependent options are included in each chapter.

CODE EAN/UPC on page 78
UPC-A on page 79
UPC-E on page 82
GTIN FORMATTING on page 85
EAN 13 (JAN 13) on page 85
ISSN on page 87
EAN 8 on page 88
UPC/EAN GLOBAL SETTINGS on page 90
ADD-ONS on page 93
CODE 39 on page 97
CODE 32 (ITAL PHARMACEUTICAL CODE) on page 107
CODE 39 CIP (FRENCH PHARMACEUTICAL) on page 108
CODE 128 on page 109
GS1-128 on page 117
CODE ISBT 128 on page 118
INTERLEAVED 2 OF 5 (I 2 OF 5) on page 121
INTERLEAVED 2 OF 5 CIP HR on page 129
DATALOGIC 2 OF 5 on page 130
FOLLETT 2 OF 5 (ONLY STANDARD OPTIC MODELS) on page 135
STANDARD 2 OF 5 on page 136
INDUSTRIAL 2 OF 5 (ONLY STANDARD OPTIC MODELS) on page 141
CODE IATA (ONLY STANDARD OPTIC MODELS) on page 146
CODABAR on page 147
ABC CODABAR on page 158
CODE 11 (ONLY STANDARD OPTIC MODELS) on page 160
GS1 DATABAR™ OMNIDIRECTIONAL on page 168

GS1 DATABAR™ EXPANDED on page 170
GS1 DATABAR™ LIMITED on page 175
CODE 93 on page 177
CODABLOCK F on page 184
CODE 4 on page 188
CODE 5 on page 190
CODE 4 AND CODE 5 COMMON CONFIGURATION ITEMS on page 192
BC412 on page 194
MSI on page 200
PLESSEY (ONLY STANDARD OPTIC MODELS) on page 206

Default settings are indicated at each feature/option with a green arrow. Also reference [Appendix C, Standard Defaults](#) for a listing of the most widely used set of standard factory settings. That section also provides space to record any custom settings needed or implemented for your system.

To set most features:

1. Scan the ENTER/EXIT PROGRAMMING bar code at the top of applicable programming pages.
2. Scan the correct bar code to set the desired programming feature or parameter. You may need to cover unused bar codes on the page, and possibly the facing page, to ensure that the reader reads only the bar code you intend to scan.
3. If additional input parameters are needed, go to [Appendix D, Keypad](#), and scan the appropriate characters from the keypad.



Additional information about many features can be found in the "References" chapter.

If you make a mistake before the last character, scan the CANCEL bar code to abort and not save the entry string. You can then start again at the beginning.

4. Complete the programming sequence by scanning the ENTER/EXIT PROGRAMMING bar code to exit Programming Mode.



DISABLE ALL SYMBOLOGIES

Use this feature to disable all symbologies.

1. Scan the ENTER/EXIT PROGRAMMING Mode bar code.
2. Scan the Disable All Symbologies bar code.
3. Complete the programming sequence by scanning the ENTER/EXIT PROGRAMMING bar code.



Disable All Symbologies

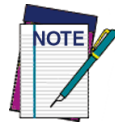

This does not disable the reading of programming labels.



CODE EAN/UPC

Coupon Control

This setting has no effect for AR models.

This feature is used to control the reader's method of processing coupon labels.

Options are:

- Allow all — allow all coupon bar codes to be decoded
- Enable only UPC/EAN — enables only UPC/EAN coupon decoding
- Enable only GS1 DataBar — enables only GS1 DataBar coupon decoding

To set this feature:

1. Scan the Enter/Exit bar code.
2. Scan either the enable or disable bar code below. You'll need to cover any unused bar codes on this and the facing page to ensure that the scanner sees only the bar code you intend to scan.
3. Complete the programming sequence by scanning the Enter/Exit bar code.



Coupon Control = Allow all



Coupon Control = Enable only UPC/EAN

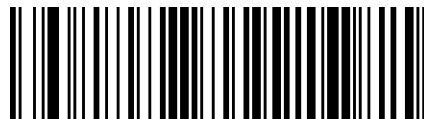

Coupon Control = Enable only GS1 DataBar



UPC-A

The following options apply to the UPC-A symbology.

UPC-A Enable/Disable

When disabled, the reader will not read UPC-A bar codes.



UPC-A = Disable

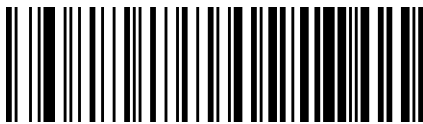

UPC-A = Enable



UPC-A Check Character Transmission

Enable this option to transmit the check character along with UPC-A bar code data.



UPC-A Check Character Transmission = Don't Send



UPC-A Check Character Transmission = Send





Expand UPC-A to EAN-13

Expands UPC-A data to the EAN-13 data format. Selecting this feature also changes the symbology ID to match those required for EAN-13.

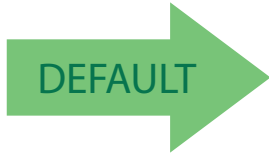

UPC-A to EAN-13 = Don't Expand

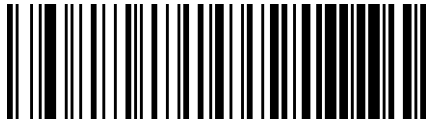

UPC-A to EAN-13 = Expand

UPC-A Number System Character Transmission

This feature enables/disables transmission of the UPC-A number system character.



UPC-A Number System Character = Do not transmit



UPC-A Number System Character = Transmit





In-Store Minimum Reads

This setting has no effect for AR models.

This feature specifies the minimum number of consecutive times an in-store label must be decoded before it is accepted as good read.

In-store labels are defined as UPC-A labels with a number-system character of 2 or 4 as well as EAN 8 and EAN 13 labels with a Flag1 character of 2 or an EAN 13 label starting with the three characters '980'.

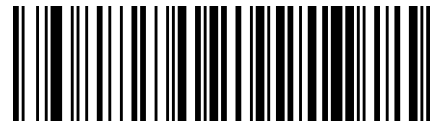

In-Store Minimum Reads = 1



In-Store Minimum Reads = 2

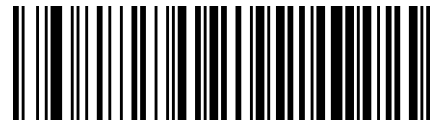

In-Store Minimum Reads = 3



In-Store Minimum Reads = 4

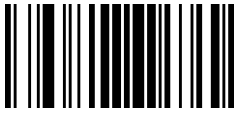

UPC-E

The following options apply to the UPC-E symbology.

UPC-E Enable/Disable

When disabled, the reader will not read UPC-E bar codes.



UPC-E = Disable

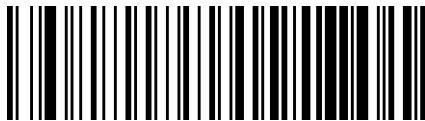

UPC-E = Enable



UPC-E Check Character Transmission

Enable this option to transmit the check character along with UPC-E bar code data.



UPC-E Check Character Transmission = Don't Send



UPC-E Check Character Transmission = Send





Expand UPC-E to EAN-13

Expands UPC-E data to the EAN-13 data format. Selecting this feature also changes the symbology ID to match those required for EAN-13.

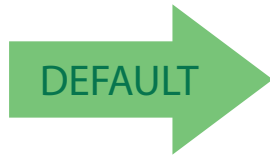

UPC-E to EAN-13 = Don't Expand

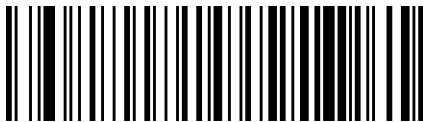

UPC-E to EAN-13 = Expand

Expand UPC-E to UPC-A

Expands UPC-E data to the UPC-A data format.

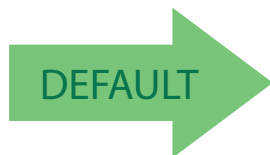

UPC-E to UPC-A = Don't Expand



UPC-E to UPC-A = Expand

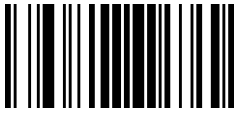

UPC-E Number System Character Transmission

This feature enables/disables transmission of the UPC-E system number character.



UPC-E Number System Character = Do not transmit



UPC-E Number System Character = Transmit



UPC-E Minimum Read

This setting has no effect for AR models.

This feature specifies the minimum number of consecutive times a UPC-E label must be decoded before it is accepted as good read.

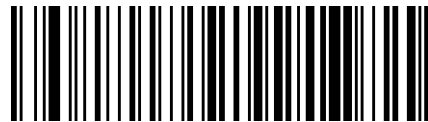

UPC-E Minimum Reads = 1



UPC-E Minimum Reads = 2



UPC-E Minimum Reads = 3



UPC-E Minimum Reads = 4



GTIN FORMATTING

This feature enables/disables the ability to convert UPC-E, UPC-A, and EAN 13 labels into the GTIN 14-character format.



If add-on information is present on the base label prior to the conversion taking place, the add-on information will be appended to the converted GTIN label.

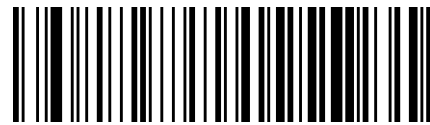
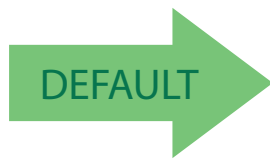

GTIN Formatting = Disable

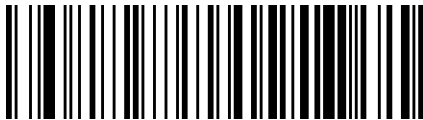

GTIN Formatting = Enable

EAN 13 (JAN 13)

The following options apply to the EAN 13 (Jan 13) symbology.

EAN 13 Enable/Disable

When disabled, the reader will not read EAN 13/JAN 13 bar codes.



EAN 13 = Disable



EAN 13 = Enable



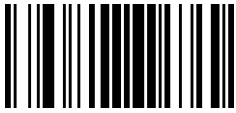

EAN 13 Check Character Transmission

Enable this option to transmit the check character along with EAN 13 bar code data.

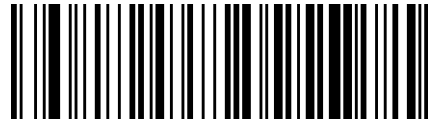

EAN 13 Check Character Transmission = Don't Send

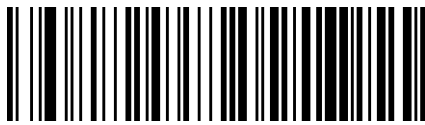

EAN 13 Check Character Transmission = Send



EAN-13 Flag 1 Character

Enables/disables transmission of an EAN/JAN13 Flag1 character. The Flag 1 character is the first character of the label.



EAN-13 Flag 1 Char= Don't transmit



EAN-13 Flag 1 Char= Transmit



EAN-13 ISBN Conversion

This option enables/disables conversion of EAN 13/JAN 13 Bookland labels starting with 978 to ISBN labels.

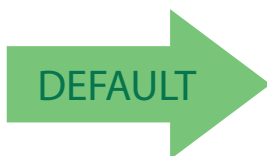

EAN-13 ISBN Conversion = Disable



EAN-13 ISBN Conversion = Convert to ISBN



ISSN

The following options apply to the ISSN symbology.

ISSN Enable/Disable

Enables/disables conversion of EAN/JAN13 Bookland labels starting with 977 to ISSN labels.

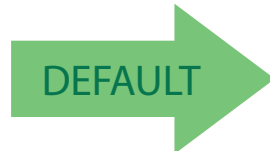

ISSN = Disable

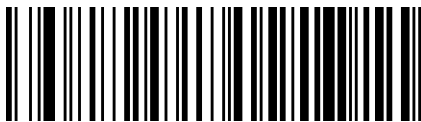

ISSN = Enable

EAN 13 Minimum Reads

This setting has no effect for AR models.

This feature specifies the minimum number of consecutive times an EAN 13 label must be decoded before it is accepted as good read.



EAN 13 Minimum Reads = 1



EAN 13 Minimum Reads = 2



EAN 13 Minimum Reads = 3



EAN 13 Minimum Reads = 4

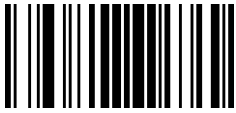

EAN 8

The following options apply to the ISSN symbology.

EAN 8 Enable/Disable

The following options apply to the ISSN symbology.

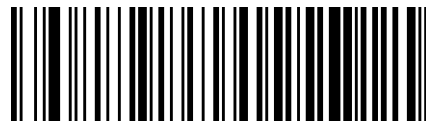

EAN 8 = Disable

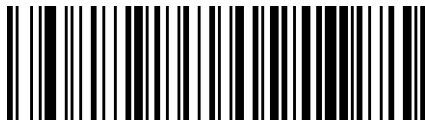

EAN 8 = Enable



EAN 8 Check Character Transmission

Enable this option to transmit the check character along with EAN 8 barcode data

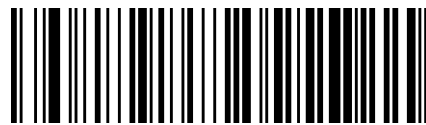

EAN 8 Check Character Transmission = Don't Send



EAN 8 Check Character Transmission = Send





EAN 8 to EAN 13

Enable this option to expand EAN 8/JAN 8 labels to EAN 13/Jan 13.

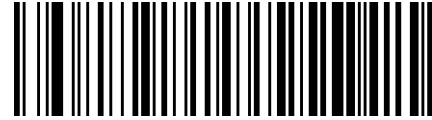
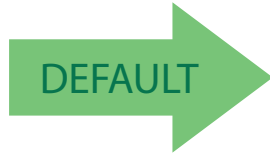

Expand EAN 8 to EAN 13 = Disable

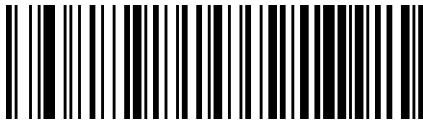

Expand EAN 8 to EAN 13 = Enable

EAN 8 Minimum Reads

This setting has no effect for AR models.

This feature specifies the minimum number of consecutive times an EAN 8 (Jan 8) label must be decoded before it is accepted as good read.

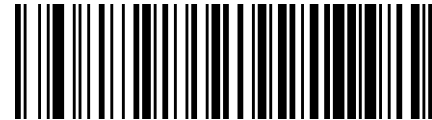

EAN 8 Minimum Reads = 1



EAN 8 Minimum Reads = 2



EAN 8 Minimum Reads = 3



EAN 8 Minimum Reads = 4

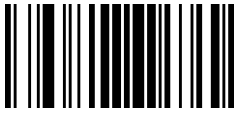

UPC/EAN GLOBAL SETTINGS

This section provides configuration settings for UPC-A, UPC-E, EAN 13 symbologies, and affects all of these unless otherwise marked for each feature description.

UPC/EAN Decoding Levels

Decoding Levels are used to configure a bar code symbology decoder to be very aggressive to very conservative depending on a particular customer's needs

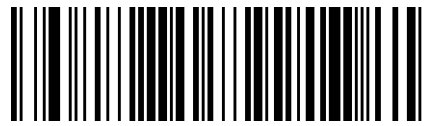

UPC/EAN Decoding Level = 1

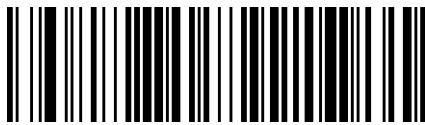

UPC/EAN Decoding Level = 2

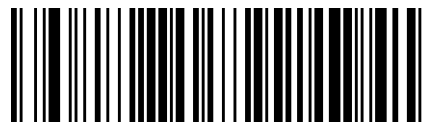
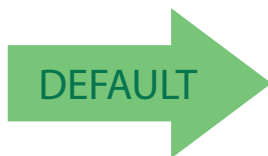

UPC/EAN Decoding Level = 3



UPC/EAN Decoding Level = 4



UPC/EAN Decoding Level = 5



UPC/EAN Price Weight Check

This setting has no effect for AR models.

This feature enables/disables calculation and verification of price/weight check digits.

Options are:

- Disabled
- Enable 4-digit price-weight check-digit calculation
- Enable 5-digit price-weight check-digit calculation
- Enable European 4-digit price-weight check-digit calculation
- Enable European 5-digit price-weight check-digit calculation



Price Weight Check = Disable

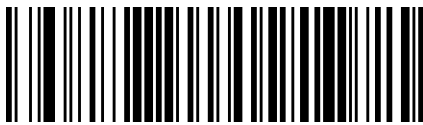

Price Weight Check = 4-digit price-weight check



Price Weight Check = 5-digit price-weight check



Price Weight Check = European 4-digit price-weight check



Price Weight Check = European 5-digit price-weight check

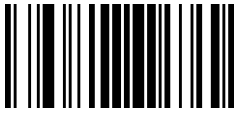

UPC-A Minimum Reads

This setting has no effect for AR models.

This feature specifies the minimum number of consecutive times a UPC-A label must be decoded before it is accepted as good read.

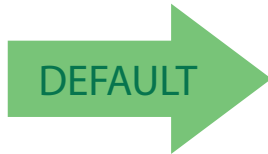

UPC-A Minimum Reads = 1



UPC-A Minimum Reads = 2



UPC-A Minimum Reads = 3



UPC-A Minimum Reads = 4

UPC/EAN Quiet Zones

This feature specifies the number of quiet zones for UPC/EAN labels. Quiet zones are blank areas at the ends of a bar code, typically 10 times the width of the narrowest bar or space in the label. The property applies to all EAN-UPC symbologies globally and to the ADDONS.

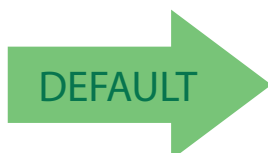

UPC/EAN Quiet Zones = Two Modules



UPC/EAN Quiet Zones = Three Modules



ADD-ONS

Contact Customer Support for advanced programming of optional and conditional add-ons.



Contact Customer Support for advanced programming of optional and conditional add-ons.

Optional Add-ons

The reader can be enabled to optionally read the following add-ons (supplementals):

- P2
- P5



If a UPC/EAN base label and an add-on are both decoded, the reader will transmit the base label and add-on. If a UPC/EAN base label is decoded without an add-on, the base label will be transmitted without an add-on. Conditional add-on settings (if enabled) are considered by the reader before optional add-on settings.

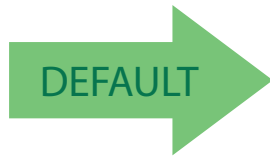

Optional Add-Ons = Disable P2



Optional Add-Ons = Enable P2

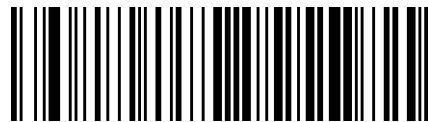
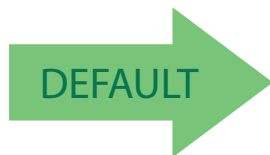

Optional Add-Ons = Disable P5



Optional Add-Ons = Enable P5

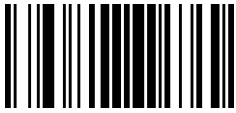

Optional Add-On Timer

This setting has no effect for AR models.

This option sets the time the reader will look for an add-on when an add-on fragment has been seen and optional add-ons are enabled.

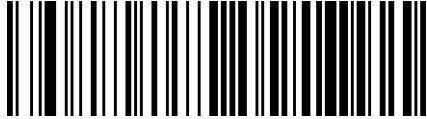

Optional Add-on Timer = 10ms



Optional Add-on Timer = 20ms

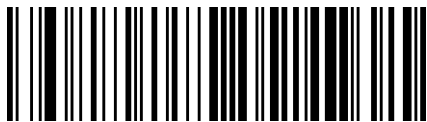

Optional Add-on Timer = 30ms

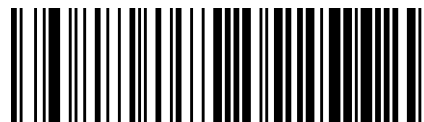

Optional Add-on Timer = 50ms



Optional Add-on Timer = 70ms

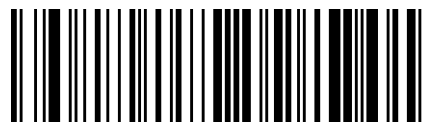

Optional Add-on Timer = 100ms



Optional Add-on Timer = 160ms



P2 Add-Ons Minimum Reads

This setting has no effect for AR models.

This feature specifies the minimum number of times a P2 add-on must be read before it is marked as valid and then combined with a base label.



P2 Add-Ons Minimum Reads = 1



P2 Add-Ons Minimum Reads = 2



P2 Add-Ons Minimum Reads = 3



P2 Add-Ons Minimum Reads = 4

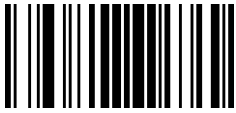

P5 Add-Ons Minimum Reads

This setting has no effect for AR models.

This feature specifies the minimum number of times a P5 add-on must be read before it is marked as valid and then combined with a base label.

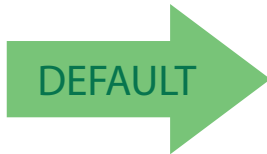

P5 Add-Ons Minimum Reads = 1



P5 Add-Ons Minimum Reads = 2

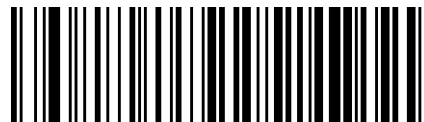

P5 Add-Ons Minimum Reads = 3



P5 Add-Ons Minimum Reads = 4



CODE 39

The following options apply to the Code 39 symbology.

Code 39 Enable/Disable

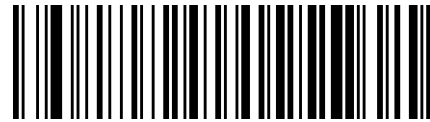

Code 39 = Disable



Code 39 = Enable



Code 39 Check Character Calculation

Enable this option to enables/disables calculation and verification of an optional Code 39 check character. When disabled, any check character in the label is treated as a data character.

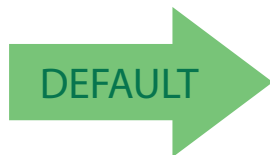

Code 39 Check Character Calculation = Don't Calculate



Code 39 Check Character Calculation =
Calculate Std Check



Code 39 Check Character Calculation =
Calculate Mod 7 Check (no AR)



Enter/Exit Programming Mode

Code 39 Check Character Calculation (continued)

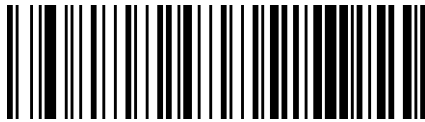

Code 39 Check Character Calculation =
Enable Italian Post Check (no AR)

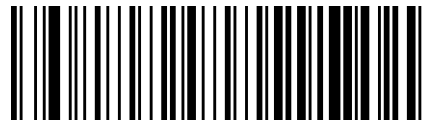

Code 39 Check Character Calculation =
Enable Daimler Chrysler Check (no AR)

Code 39 Check Character Transmission

Enable this option to transmit the check character along with Code 39 bar code data.



Code 39 Check Character Transmission = Don't Send



Code 39 Check Character Transmission = Send





Code 39 Start/Stop Character Transmission

Enable this option to enable/disable transmission of Code 39 start and stop characters.

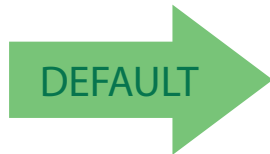

Code 39 Start/Stop Character Transmission =
Don't Transmit

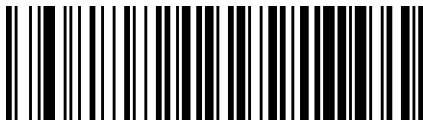

Code 39 Start/Stop Character Transmission = Transmit

Code 39 Full ASCII

Enables/disables the translation of Code 39 characters to Code 39 full-ASCII characters.

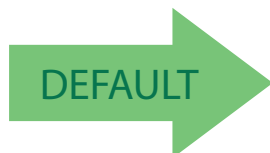

Code 39 Full ASCII = Disable



Code 39 Full ASCII = Enable



Code 39 Quiet Zones

This setting has no effect for AR models.

This feature specifies the number of quiet zones for Code 39 labels. Quiet zones are blank areas at the ends of a bar code, typically 10 times the width of the narrowest bar or space in the label.

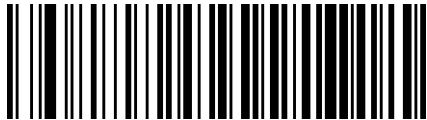

Code 39 Quiet Zones = Quiet Zone on one side



Code 39 Quiet Zones = Quiet Zones on two sides



Code 39 Quiet Zones = Auto



Code 39 Quiet Zones = Virtual Quiet Zones on two sides



Code 39 Quiet Zones = Small Quiet Zones on two sides



Code 39 Minimum Reads

This setting has no effect for AR models.

This feature specifies the minimum number of consecutive times a Code 39 label must be decoded before it is accepted as good read.



Code 39 Minimum Reads = 1



Code 39 Minimum Reads = 2



Code 39 Minimum Reads = 3



Code 39 Minimum Reads = 4



Code 39 Decoding Levels

This setting has no effect for AR models.

Decoding Levels are used to configure a bar code symbology decoder to be very aggressive to very conservative depending on a particular customer's needs.



Code 39 Decoding Level = Disable

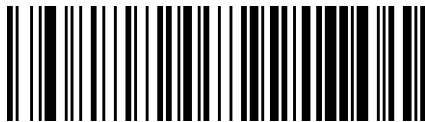

Code 39 Decoding Level = 1



Code 39 Decoding Level = 2



Code 39 Decoding Level = 3



Code 39 Decoding Level = 4



Code 39 Decoding Level = 5



Code 39 Length Control

This feature specifies either variable length decoding or fixed length decoding for the Code 39 symbology.

Variable Length. For variable length decoding, a minimum and maximum length may be set.

Fixed Length. For fixed length decoding, two different lengths may be set.

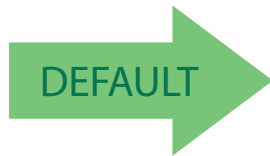

Code 39 Length Control = Variable Length

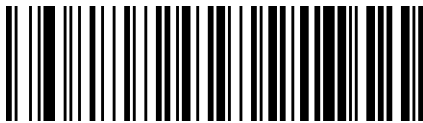

Code 39 Length Control = Fixed Length



Code 39 Set Length 1

This feature specifies one of the bar code lengths for Code 39 Length Control. Length 1 is the minimum label length if in Variable Length Mode, or the first fixed length if in Fixed Length Mode. Length includes the bar code's data characters only. The length can be set from 0 to 50 characters.

Table 4 provides examples for setting Length 1. See page 297 for detailed instructions on setting this feature.

Table 4. Code 39 Length 1 Setting Examples

STEP	ACTION	EXAMPLES			
1	Desired Setting	00 Characters	07 Characters	15 Characters	50 Characters
2	Scan ENTER/EXIT PROGRAMMING MODE				
3	Scan SELECT CODE 39 LENGTH 1 SETTING				
4	Scan Two Characters From Appendix D, Keypad	'0' and '0'	'0' and '7'	'1' and '5'	'5' AND '0'
5	Scan ENTER/EXIT PROGRAMMING MODE				

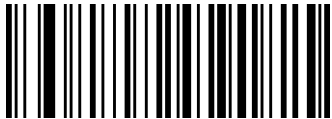

Select Code 39 Set Length 1 Setting

Make a mistake? Scan the CANCEL bar code to abort and not save the entry string. You can then start again at the beginning.

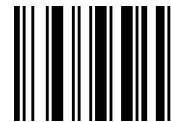

CANCEL

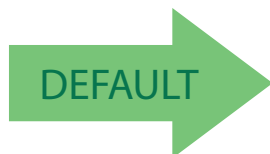

02 = Length 1 is 2 Characters



Code 39 Set Length 2

This feature specifies one of the bar code lengths for **Code 39 Length Control**. Length 2 is the maximum label length if in **Variable Length Mode**, or the second fixed length if in **Fixed Length Mode**. Length includes the bar code's check, data, and full-ASCII shift characters. The length does not include start/stop characters.

Table 5 provides examples for setting Length 2. See page 298 for detailed instructions on setting this feature.

Table 5. Code 39 Length 2 Setting Examples

STEP	ACTION	EXAMPLES			
1	Desired Setting	00 (Ignore This Length)	07 Characters	15 Characters	50 Characters
2	Scan ENTER/EXIT PROGRAMMING MODE				
3	Scan SELECT CODE 39 LENGTH 2 SETTING				
4	Scan Two Characters From Appendix D, Keypad	'0' and '0'	'0' and '7'	'1' and '5'	'5' AND '0'
5	Scan ENTER/EXIT PROGRAMMING MODE				

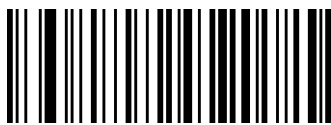

Select Code 39 Length 2 Setting

Make a mistake? Scan the CANCEL bar code to abort and not save the entry string. You can then start again at the beginning.



CANCEL

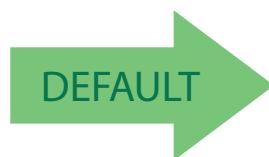

50 = Length 2 is 50 Characters

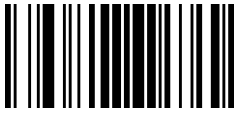

Code 39 Interdigit Ratio

This setting has no effect for AR models.

This feature specifies the ratio between an intercharacter space and module for Code 39 labels.

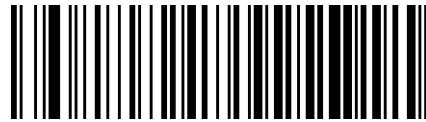

Code 39 Interdigit Ratio = Disable



Code 39 Interdigit Ratio = 1

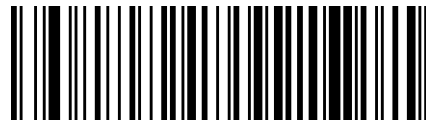

Code 39 Interdigit Ratio = 2



Code 39 Interdigit Ratio = 3

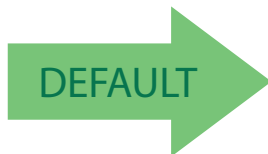

Code 39 Interdigit Ratio = 4



Code 39 Interdigit Ratio = 5



CODE 32 (ITAL PHARMACEUTICAL CODE)

The following options apply to the Code 32 (Italian Pharmaceutical Code) symbology.

Code 32 Enable/Disable

When disabled, the reader will not read Code 32 bar codes.

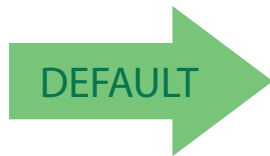

Code 32 = Disable



Code 32 = Enable

Code 32 Feature Setting Exceptions



The following features are set for Code 32 by using these Code 39 settings:

"Code 39 Quiet Zones" on page 100

"Code 39 Length Control" on page 103

Code 32 Check Character Transmission

Enable this option to transmit the check character along with Code 32 bar code data.



Code 32 Check Character Transmission = Don't Send



Code 32 Check Character Transmission = Send

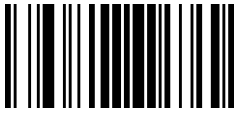

Code 32 Start/Stop Character Transmission

This option enables/disables transmission of Code 32 start and stop characters.

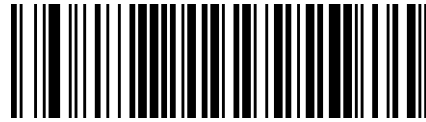
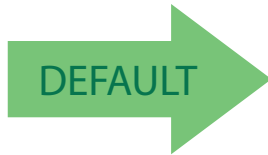

Code 32 Start/Stop Character Transmission =
Don't Transmit

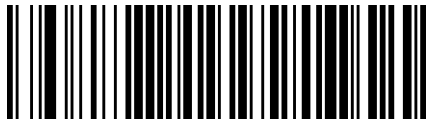

Code 32 Start/Stop Character Transmission = Transmit

CODE 39 CIP (FRENCH PHARMACEUTICAL)

The following options apply to the Code 39 CIP symbology.

Code 39 CIP Enable/Disable

This setting has no effect for AR models.

Enables/Disables ability of the reader to decode Code 39 CIP labels.

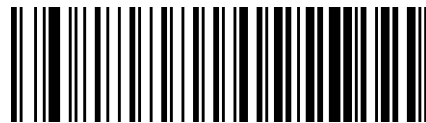
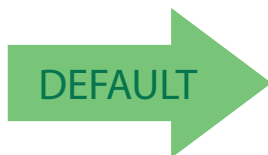

Code 39 CIP = Disable



Code 39 CIP = Enable



CODE 128

The following options apply to the Code 128 symbology.

Code 128 Enable/Disable

When disabled, the reader will not read Code 128 bar codes.



Code 128 = Disable



Code 128 = Enable



Expand Code 128 to Code 39

This feature enables/disables expansion of Code 128 labels to Code 39 labels.

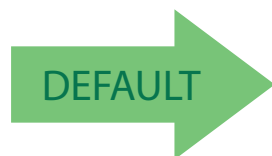

Code 128 to Code 39 = Don't Expand



Code 128 to Code 39 = Expand



Code 128 Check Character Transmission

This setting has no effect for AR models.

Enable this option to transmit the check character along with Code 128 bar code data.

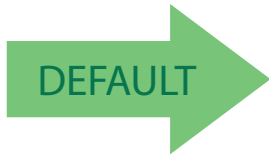

Code 128 Check Character Transmission = Don't Send

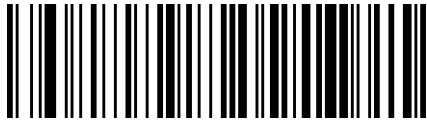

Code 128 Check Character Transmission = Send

Code 128 Function Character Transmission

This setting has no effect for AR models.

Enables/disables transmission of Code128 function characters 1, 2, 3, and 4.

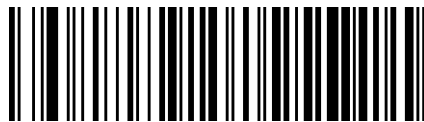
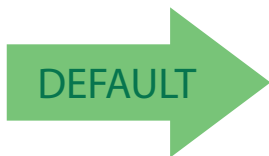

Code 128 Function Character Transmission = Don't Send

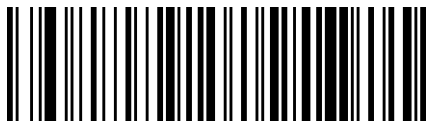

Code 128 Function Character Transmission = Send



Code 128 Sub-Code Exchange Transmission

This setting has no effect for AR models.

Enables/disables the transmission of “Sub-Code Exchange” characters (NOT transmitted by standard decoding).

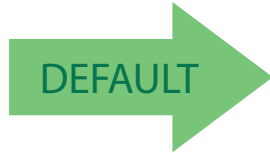

Code 128 Sub-Code Exchange Transmission = Disable



Code 128 Sub-Code Exchange Transmission = Enable

Code 128 Quiet Zones

This setting has no effect for AR models.

This feature specifies the number of quiet zones for Code 128 labels. Quiet zones are blank areas at the ends of a bar code and are typically 10 times the width of the narrowest bar or space in the label.



Code 128 Quiet Zones = No Quiet Zones

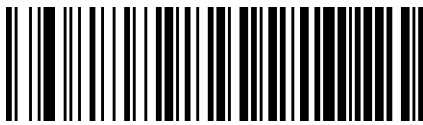

Code 128 Quiet Zones = Quiet Zone on one side



Code 128 Quiet Zones = Quiet Zones on two sides

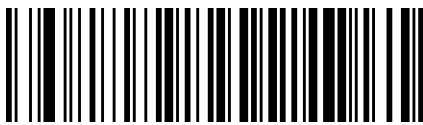

Code 128 Quiet Zones = Auto



Code 128 Quiet Zones = Virtual Quiet Zones on two sides



Code 128 Minimum Reads

This setting has no effect for AR models.

This feature specifies the minimum number of consecutive times a Code 128 label must be decoded before it is accepted as good read.

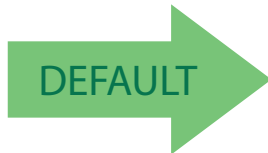

Code 128 Minimum Reads = 1

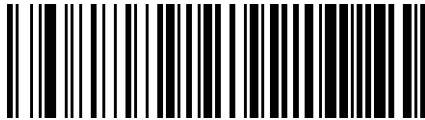

Code 128 Minimum Reads = 2



Code 128 Minimum Reads = 3



Code 128 Minimum Reads = 4



Code 128 Decoding Levels

This setting has no effect for AR models.

Decoding Levels are used to configure a bar code symbology decoder to be very aggressive to very conservative depending on a particular customer's needs.



Code 128 Decoding Level = Disable

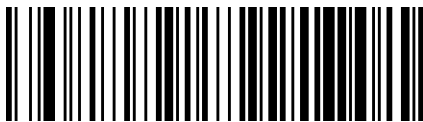

Code 128 Decoding Level = 1



Code 128 Decoding Level = 2



Code 128 Decoding Level = 3



Code 128 Decoding Level = 4



Code 128 Decoding Level = 5



Code 128 Length Control

This feature specifies either variable length decoding or fixed length decoding for the Code 128 symbology.

Variable Length. For variable length decoding, a minimum and maximum length may be set.

Fixed Length. For fixed length decoding, two different lengths may be set.

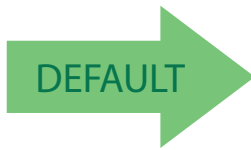

Code 128 Length Control = Variable Length



Code 128 Length Control = Fixed Length



Code 128 Set Length 1

Specifies one of the bar code lengths for **Code 128 Length Control**. Length 1 is the minimum label length if in **Variable Length Mode**, or the first fixed length if in **Fixed Length Mode**. Length includes the bar code's data characters only. The length can be set from 1 to 80 characters.

Table 6 provides some examples for setting Length 1. See page 297 for detailed instructions on setting this feature.

Table 6. Code 128 Length 1 Setting Examples

STEP	ACTION	EXAMPLES			
1	Desired Setting	01 Character	07 Characters	15 Characters	80 Characters
2	Scan ENTER/EXIT PROGRAMMING MODE				
3	Scan SELECT CODE 128 LENGTH 1 SETTING				
4	Scan Two Characters From Appendix D, Keypad	'0' and '1'	'0' and '7'	'1' and '5'	'8' AND '0'
5	Scan ENTER/EXIT PROGRAMMING MODE				

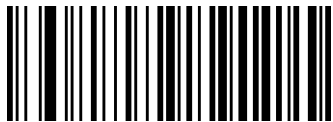

Select Code 128 Set Length 1 Setting

To configure this feature, scan the ENTER/EXIT bar code above, then the bar code at left followed by digits from the Alphanumeric characters in **Appendix D, Keypad** representing your desired character(s). End by scanning the ENTER/EXIT bar code again.

Make a mistake? Scan the CANCEL bar code to abort and not save the entry string. You can then start again at the beginning.



CANCEL

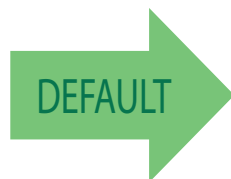

01 = Length 1 is 1 Character



Code 128 Set Length 2

This feature specifies one of the bar code lengths for **Code 128 Length Control**. Length 2 is the maximum label length if in **Variable Length Mode**, or the second fixed length if in **Fixed Length Mode**. Length includes the bar code's data characters only.

The length can be set from 1 to 80 characters. A setting of 0 specifies to ignore this length (only one fixed length).

Table 7 provides examples for setting Length 2. See page 298 for detailed instructions on setting this feature.

Table 7. Code 128 Length 2 Setting Examples

STEP	ACTION	EXAMPLES			
1	Desired Setting	00 (Ignore This Length)	07 Characters	15 Characters	80 Characters
2	Scan ENTER/EXIT PROGRAMMING MODE				
3	Scan SELECT CODE 128 LENGTH 2 SETTING				
4	Scan Two Characters From Appendix D, Keypad	'0' and '0'	'0' and '7'	'1' and '5'	'8' and '0'
5	Scan ENTER/EXIT PROGRAMMING MODE				



Select Code 128 Length 2 Setting

To configure this feature, scan the ENTER/EXIT bar code above, then the bar code at left followed by digits from the Alphanumeric characters in **Appendix D, Keypad** representing your desired character(s). End by scanning the ENTER/EXIT bar code again.

Make a mistake? Scan the CANCEL bar code to abort and not save the entry string. You can then start again at the beginning.



CANCEL

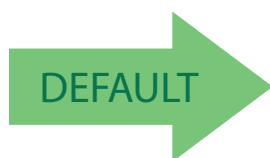

80 = Length 2 is 80 Characters



GS1-128

The following options apply to the GS1-128 symbology. (Also known as USS-128, GS1-128, GTIN-128, UCC-128, EAN-128.)

GS1-128 Enable

This option enables/disables the ability of the reader to translate GS1-128 labels to the GS1-128 data format. Options are:

- Transmit GS1-128 labels in Code 128 data format.
- Transmit GS1-128 labels in GS1-128 data format.
- Do not transmit GS1-128 labels.

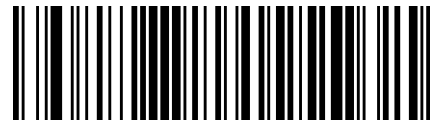

GS1-128 = Transmit in Code 128 data format
(not available for AR models)

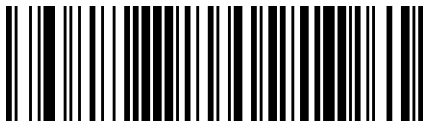

GS1-128 = Transmit in GS1-128 data format



GS1-128 = Do not transmit GS1-128 labels



CODE ISBT 128

This setting has no effect for AR models.
The following options apply to the ISBT 128 symbology.

ISBT 128 Concatenation

Use this option to enable/disable ISBT128 concatenation of 2 labels.

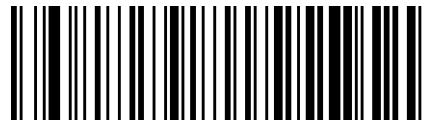
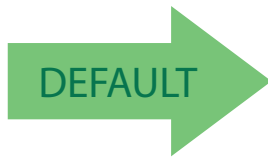

ISBT 128 Concatenation = Disable



ISBT 128 Concatenation = Enable

ISBT 128 Force Concatenation

When enabled, this feature forces concatenation for ISBT.



This option is only valid when ISBT 128 Concatenation is enabled.

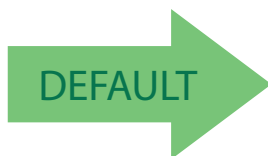

ISBT 128 Force Concatenation = Disable



ISBT 128 Force Concatenation = Enable



ISBT 128 Concatenation Mode

Specifies the concatenation mode between Static and Dynamic.



This option is only valid when ISBT 128 Concatenation is enabled (see "ISBT 128 Concatenation" on page 118).

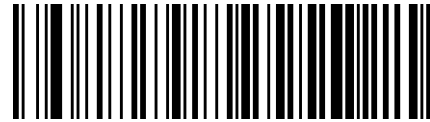
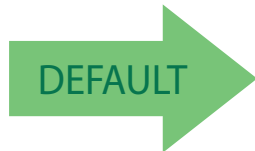

ISBT 128 Concatenation Mode = Static



ISBT 128 Concatenation Mode = Dynamic

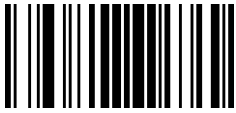

ISBT 128 Dynamic Concatenation Timeout

This setting has no effect for AR models.

Specifies the timeout used by the ISBT 128 Dynamic Concatenation Mode.

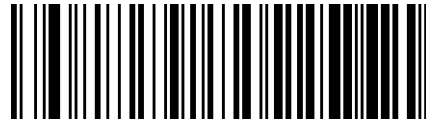

ISBT 128 Dynamic Concatenation Timeout = 50 msec

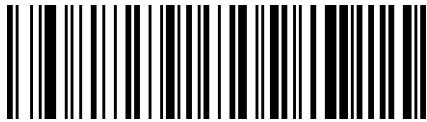

ISBT 128 Dynamic Concatenation Timeout = 100 msec

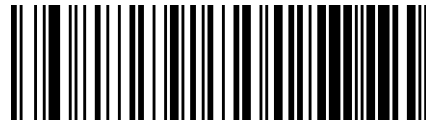
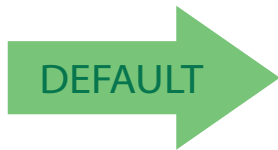

ISBT 128 Dynamic Concatenation Timeout = 200 msec



ISBT 128 Dynamic Concatenation Timeout = 500 msec



ISBT 128 Dynamic Concatenation Timeout = 750 msec



ISBT 128 Dynamic Concatenation Timeout = 1 second



ISBT 128 Advanced Concatenation Options



To set up pairs of label types for concatenation, use the Datalogic Aladdin configuration application or contact Datalogic Technical Support, as described on [page 2](#).

INTERLEAVED 2 OF 5 (I 2 OF 5)

The following options apply to the I 2 of 5 symbology.

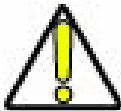

CAUTION

When reading this symbology, the settings for I 2 of 5 Length Control AND I 2 of 5 Check Character Calculation **MUST** be enabled to increase decoding safety.

I 2 of 5 Enable/Disable

When disabled, the reader will not read I 2 of 5 bar codes.

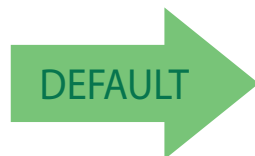

I 2 of 5 = Disable



I 2 of 5 = Enable



I 2 of 5 Check Character Calculation

This option enables/disables calculation and verification of an optional I 2 of 5 check character. Combinations of these settings are possible via the Aladdin configuration utility, or contact Technical Support.

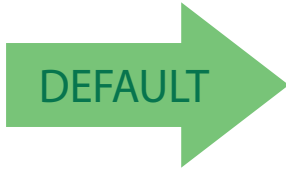

I 2 of 5 Check Character Calculation = Disable

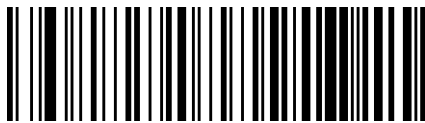

I 2 of 5 Check Character Calculation = Check Standard
(Modulo 10) (no AR)

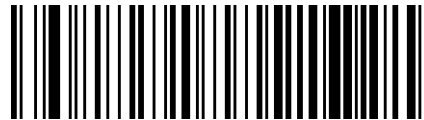

I 2 of 5 Check Character Calculation = Check German Parcel



I 2 of 5 Check Character Calculation = Check DHL (no AR)



I 2 of 5 Check Character Calculation = Check Daimler Chrysler



I 2 of 5 Check Character Calculation = Check Bosch (no AR)



I 2 of 5 Check Character Calculation = Check Italian Post

When disabled, any check character in label is treated as a data character.



I 2 of 5 Check Character Transmission

Enable this option to transmit the check character along with I 2 of 5 bar code data.



This feature is valid only when I 2 of 5 Check Character Calculation is enabled.

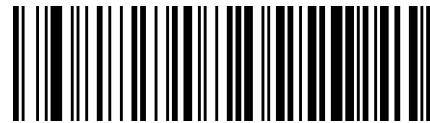

I 2 of 5 Check Character Transmission = Don't Send

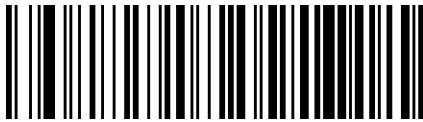

I 2 of 5 Check Character Transmission = Send



I 2 of 5 Minimum Reads

This setting has no effect for AR models.

This feature specifies the minimum number of consecutive times an I 2 of 5 label must be decoded before it is accepted as good read.



I 2 of 5 Minimum Reads = 1



I 2 of 5 Minimum Reads = 2



I 2 of 5 Minimum Reads = 3



I 2 of 5 Minimum Reads = 4



1 2 of 5 Decoding Levels



This configuration item applies to Interleaved 2 of 5, Datalogic 2 of 5 and Standard 2 of 5.

This setting has no effect for AR models.

Decoding Levels are used to configure a bar code symbology decoder to be very aggressive to very conservative depending on a particular customer's needs.



2 of 5 Decoding Level = Disable



2 of 5 Decoding Level = 1



2 of 5 Decoding Level = 2



2 of 5 Decoding Level = 3



2 of 5 Decoding Level = 4



2 of 5 Decoding Level = 5



I 2 of 5 Length Control

This feature specifies either variable length decoding or fixed length decoding for the I 2 of 5 symbology.

Variable Length: For variable length decoding, a minimum and maximum length may be set.

Fixed Length: For fixed length decoding, two different lengths may be set.

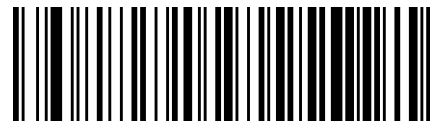
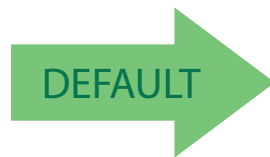

I 2 of 5 Length Control = Variable Length



I 2 of 5 Length Control = Fixed Length



I 2 of 5 Set Length 1

This feature specifies one of the bar code lengths for I 2 of 5 Length Control. Length 1 is the minimum label length if in Variable Length Mode, or the first fixed length if in Fixed Length Mode. The length includes the bar code's check and data characters. The length can be set from 2 to 50 characters in increments of two.

Table 8 provides some examples for setting Length 1. See page 297 for detailed instructions on setting this feature.

Table 8. I 2 of 5 Length 1 Setting Examples

STEP	ACTION	EXAMPLES			
1	Desired Setting	2 Characters	6 Characters	14 Characters	50 Characters
2	Pad with leading zeroes to yield two digits	02	06	14	50
3	Scan ENTER/EXIT PROGRAMMING MODE				
4	Scan SELECT I 2 of 5 LENGTH 1 SETTING				
5	Scan Two Characters From Appendix D, Keypad	'0' and '2'	'0' and '6'	'1' and '4'	'5' AND '0'
6	Scan ENTER/EXIT PROGRAMMING MODE				



Select I 2 of 5 Length 1 Setting

To configure this feature, scan the ENTER/EXIT bar code above, then the bar code at left followed by digits from the Alphanumeric characters in [Appendix D, Keypad](#) representing your desired character(s). End by scanning the ENTER/EXIT bar code again.

Make a mistake? Scan the CANCEL bar code to abort and not save the entry string. You can then start again at the beginning.



CANCEL

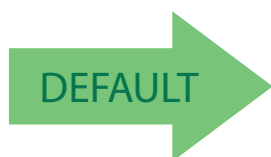

06 = Length 1 is 6 Characters



I 2 of 5 Set Length 2

This feature specifies one of the bar code lengths for I 2 of 5 Length Control. Length 2 is the maximum label length if in Variable Length Mode, or the second fixed length if in Fixed Length Mode. The length includes the bar code's check and data characters.

The length can be set from 2 to 50 characters. A setting of 0 specifies to ignore this length (only one fixed length).

Table 9 provides examples for setting Length 2. See page 298 for detailed instructions on setting this feature.

Table 9. I 2 of 5 Length 2 Setting Examples

STEP	ACTION	EXAMPLES			
1	Desired Setting	Ignore This Length	4 Characters	14 Characters	50 Characters
2	Pad with leading zeroes to yield two digits	00	04	14	50
3	Scan ENTER/EXIT PROGRAMMING MODE				
4	Scan SELECT I 2 OF 5 LENGTH 2 SETTING				
5	Scan Two Characters From Appendix D, Keypad	'0' and '0'	'0' and '4'	'1' and '4'	'5' AND '0'
6	Scan ENTER/EXIT PROGRAMMING MODE				



Select I 2 of 5 Length 2 Setting

To configure this feature, scan the ENTER/EXIT bar code above, then the bar code at left followed by digits from the Alphanumeric characters in Appendix D, Keypad representing your desired character(s). End by scanning the ENTER/EXIT bar code again.

Make a mistake? Scan the CANCEL bar code to abort and not save the entry string. You can then start again at the beginning.



CANCEL

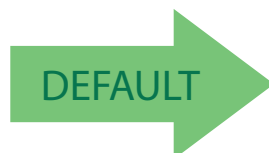

50 = Length 2 is 50 Characters



I 2 of 5 Zero Pattern

This setting has no effect for AR models.

Enables/disables ZERO-Digit decoding. This character does not represent any cipher. It allows encoding of an odd number of ciphers with Interleaved 2 of 5. It must be enabled to decode Code 2 of 5 CIP/HR.

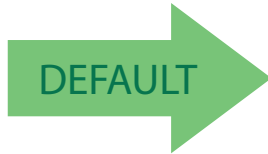

I 2 of 5 Zero Pattern = Disable



I 2 of 5 Zero Pattern = Enable



INTERLEAVED 2 OF 5 CIP HR

This setting has no effect for AR models.

The following options apply to the Interleaved 2 of 5 CIP HR symbology.

Interleaved 2 of 5 Enable/Disable

Enables/Disables ability of reader to decode Interleaved 2 of 5 CIP HR labels.

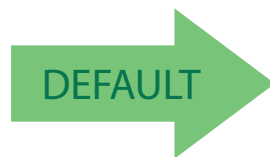

Interleaved 2 of 5 CIP HR = Disable



Interleaved 2 of 5 CIP HR = Enable



DATALOGIC 2 OF 5

This setting has no effect for AR models.

The following options apply to the Datalogic 2 of 5 symbology.

Datalogic 2 of 5 Enable/Disable

When disabled, the scanner will not read Datalogic 2 of 5 bar codes.

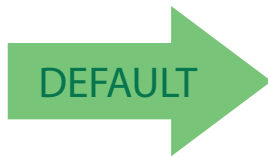

Datalogic 2 of 5 = Disable



Datalogic 2 of 5 = Enable

Datalogic 2 of 5 Check Character Calculation

This setting has no effect for AR models.

This option enables/disables calculation and verification of an optional Datalogic 2 of 5 check character.

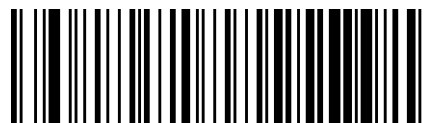
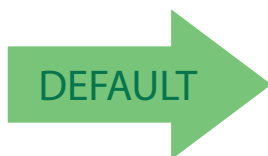

Datalogic 2 of 5 Check Character Calculation = Disable



Datalogic 2 of 5 Check Character Calculation = Enable



Datalogic 2 of 5 Check Character Transmission

This setting has no effect for AR models.

This option enables/disables transmission of an optional Datalogic 2 of 5 character.

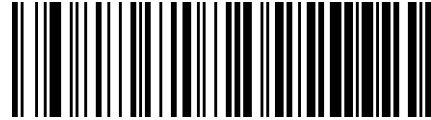

Datalogic 2 of 5 Check Character Transmission = Don't Send



Datalogic 2 of 5 Check Character Transmission = Send



Datalogic 2 of 5 Minimum Reads

This setting has no effect for AR models.

This feature specifies the minimum number of consecutive times an Datalogic 2 of 5 label must be decoded before it is accepted as good read.

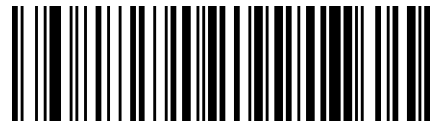

1 2 of 5 Minimum Reads = 1



1 2 of 5 Minimum Reads = 2



1 2 of 5 Minimum Reads = 3



1 2 of 5 Minimum Reads = 4

Datalogic 2 of 5 Decoding Levels



The Datalogic 2 of 5 Decoding Level feature is set using "1 2 of 5 Decoding Level" on page 135.



Datalogic 2 of 5 Length Control

This setting has no effect for AR models.

This feature specifies either variable length decoding or fixed length decoding for the Datalogic 2 of 5 symbology.

Variable Length. For variable length decoding, a minimum and maximum length may be set.

Fixed Length. For fixed length decoding, two different lengths may be set.

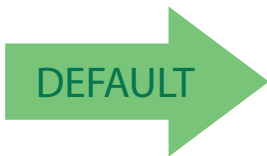

Datalogic 2 of 5 Length Control = Variable Length



Datalogic 2 of 5 Length Control = Fixed Length

Datalogic 2 of 5 Set Length 1

This setting has no effect for AR models.

This feature specifies one of the bar code lengths for **Datalogic 2 of 5 Length Control**. Length 1 is the minimum label length if in **Variable Length Mode**, or the first fixed length if in **Fixed Length Mode**. The length includes the bar code's data characters only.

The length can be set from 2 to 50 characters in increments of two. See **Set Length 1** on [page 297](#) for more detailed programming instructions.



Select Datalogic 2 of 5 Length 1 Setting

To configure this feature, scan the ENTER/EXIT bar code above, then the bar code at left followed by digits from the Alphanumeric characters in **Appendix D, Keypad** representing your desired character(s). End by scanning the ENTER/EXIT bar code again.

Make a mistake? Scan the CANCEL bar code to abort and not save the entry string. You can then start again at the beginning.



CANCEL

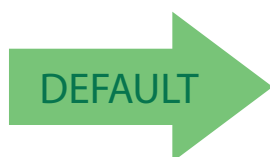

06 = Length 1 is 6 Characters



Datalogic 2 of 5 Set Length 2

This setting has no effect for AR models.

This feature specifies one of the bar code lengths for **Datalogic 2 of 5 Length Control**. Length 2 is the maximum label length if in **Variable Length Mode**, or the second fixed length if in **Fixed Length Mode**. The length includes the bar code's data characters only.

The length can be set from 2 to 50 characters. A setting of 00 specifies to ignore this length (only one fixed length). See **Set Length 2 on page 298** for more detailed programming instructions.

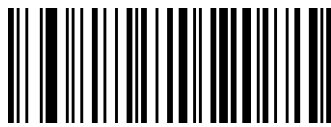

Select Datalogic 2 of 5 Length 2 Setting

To configure this feature, scan the ENTER/EXIT bar code above, then the bar code at left followed by digits from the Alphanumeric characters in **Appendix D, Keypad** representing your desired character(s). End by scanning the ENTER/EXIT bar code again.

Make a mistake? Scan the CANCEL bar code to abort and not save the entry string. You can then start again at the beginning.



CANCEL



50 = Length 2 is 50 Characters

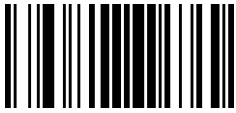

Datalogic 2 of 5 Interdigit Maximum Ratio

This setting has no effect for AR models.

This feature specifies the maximum ratio between intercharacter space and module for Datalogic 2 of 5.

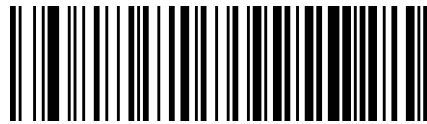

Datalogic 2 of 5 Interdigit Ratio = Disable



Datalogic 2 of 5 Interdigit Ratio = 1



Datalogic 2 of 5 Interdigit Ratio = 2



Datalogic 2 of 5 Interdigit Ratio = 3

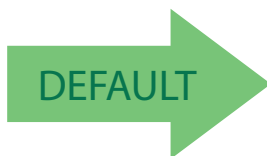

Datalogic 2 of 5 Interdigit Ratio = 4



Datalogic 2 of 5 Interdigit Ratio = 5



Datalogic 2 of 5 Interdigit Ratio = 6

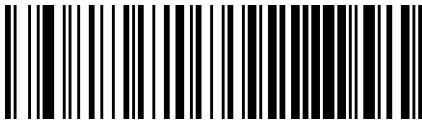

Datalogic 2 of 5 Interdigit Ratio = 7



Datalogic 2 of 5 Interdigit Ratio = 8



Datalogic 2 of 5 Interdigit Ratio = 9



Datalogic 2 of 5 Interdigit Ratio = 10

FOLLETT 2 OF 5 (ONLY STANDARD OPTIC MODELS)

The following options apply to the Follett 2 of 5 symbology.

Follett 2 of 5 Enable/Disable

Enables/Disables ability of reader to decode 2 of 5 labels.

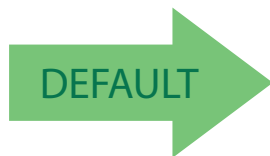

Follett 2 of 5 = Disable



Follett 2 of 5 = Enable

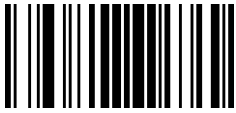

STANDARD 2 OF 5

The following options apply to the Standard 2 of 5 symbology.

Standard 2 of 5 Enable/Disable

When disabled, the reader will not read Standard 2 of 5 bar codes.

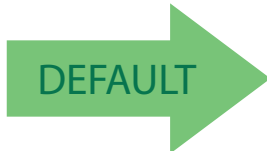

Standard 2 of 5 = Disable



Standard 2 of 5 = Enable

Standard 2 of 5 Check Character Calculation

This setting has no effect for AR models.

This option enables/disables calculation and verification of an optional Standard 2 of 5 check character.

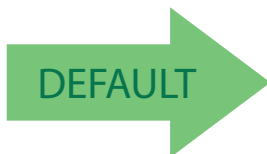

Standard 2 of 5 Check Character Calculation = Disable



Standard 2 of 5 Check Character Calculation = Enable



Standard 2 of 5 Check Character Transmission

This setting has no effect for AR models.

This feature enables/disables transmission of an optional Standard 2 of 5 check character.



Standard 2 of 5 Check Character Transmission =
Don't Send



Standard 2 of 5 Check Character Transmission = Send



Standard 2 of 5 Minimum Reads

This setting has no effect for AR models.

This feature specifies the minimum number of consecutive times a Standard 2 of 5 label must be decoded before it is accepted as good read.



Standard 2 of 5 Minimum Reads = 1



Standard 2 of 5 Minimum Reads = 2



Standard 2 of 5 Minimum Reads = 3



Standard 2 of 5 Minimum Reads = 4



Standard 2 of 5 Decoding Levels



The Standard 2 of 5 Decoding Level feature is set using "I 2 of 5 Decoding Level" on page 135.

Standard 2 of 5 Length Control

This feature specifies either variable length decoding or fixed length decoding for the Standard 2 of 5 symbology.

Variable Length. For variable length decoding, a minimum and maximum length may be set.

Fixed Length. For fixed length decoding, two different lengths may be set.

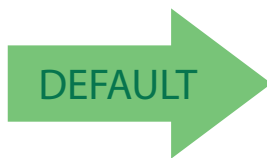

Standard 2 of 5 Length Control = Variable Length

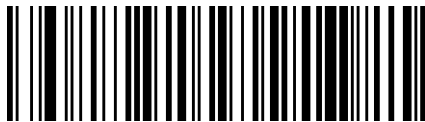

Standard 2 of 5 Length Control = Fixed Length



Standard 2 of 5 Set Length 1

This feature specifies one of the bar code lengths for **Standard 2 of 5 Length Control**. Length 1 is the minimum label length if in **Variable Length Mode**, or the first fixed length if in **Fixed Length Mode**. Length includes the bar code's check and data characters. The length can be set from 1 to 50 characters.

Table 10 provides some examples for setting Length 1. See page 297 if you want detailed instructions on setting this feature.

Table 10. Standard 2 of 5 Length 1 Setting Examples

STEP	ACTION	EXAMPLES			
1	Desired Setting	01 Character	07 Characters	15 Characters	50 Characters
2	Scan ENTER/EXIT PROGRAMMING MODE				
3	Scan SELECT STANDARD 2 OF 5 LENGTH 1 SETTING				
4	Scan Two Characters From Appendix D, Keypad	'0' and '1'	'0' and '7'	'1' and '5'	'5' AND '0'
5	Scan ENTER/EXIT PROGRAMMING MODE				



Select Standard 2 of 5 Length 1 Setting

To configure this feature, scan the ENTER/EXIT bar code above, then the bar code at left followed by digits from the Alphanumeric characters in **Appendix D, Keypad** representing your desired character(s). End by scanning the ENTER/EXIT bar code again.

Make a mistake? Scan the CANCEL bar code to abort and not save the entry string. You can then start again at the beginning.



CANCEL

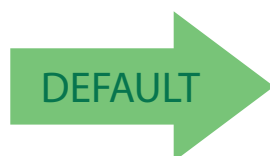

08 = Length 1 is 8 Characters

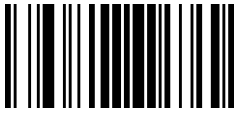

Standard 2 of 5 Set Length 2

This feature specifies one of the bar code lengths for **Standard 2 of 5 Length Control**. Length 2 is the maximum label length if in **Variable Length Mode**, or the second fixed length if in **Fixed Length Mode**. Length includes the bar code's check and data characters.

The length can be set from 1 to 50 characters. A setting of 0 specifies to ignore this length (only one fixed length).

Table 11 provides examples for setting Length 2. See [page 298](#) for detailed instructions on setting this feature.

Table 11. Standard 2 of 5 Length 2 Setting Examples

STEP	ACTION	EXAMPLES			
1	Desired Setting (pad with leading zeroes)	00 (Ignore This Length)	07 Characters	15 Characters	50 Characters
2	Scan ENTER/EXIT PROGRAMMING MODE				
3	Scan SELECT STANDARD 2 OF 5 LENGTH 2 SETTING				
4	Scan Two Characters From Appendix D, Keypad	'0' and '0'	'0' and '7'	'1' and '5'	'5' AND '0'
5	Scan ENTER/EXIT PROGRAMMING MODE				



Select Standard 2 of 5 Length 2 Setting

To configure this feature, scan the ENTER/EXIT bar code above, then the bar code at left followed by digits from the Alphanumeric characters in [Appendix D, Keypad](#) representing your desired character(s). End by scanning the ENTER/EXIT bar code again.

Make a mistake? Scan the CANCEL bar code to abort and not save the entry string. You can then start again at the beginning.



CANCEL

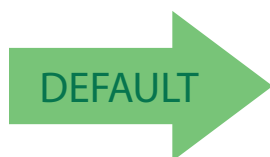

50 = Length 2 is 50 Characters



INDUSTRIAL 2 OF 5 (ONLY STANDARD OPTIC MODELS)

The following options apply to the Industrial 2 of 5 symbology.

Industrial 2 of 5 Enable/Disable

Enables/Disables ability of reader to decode Industrial 2 of 5 labels.



Industrial 2 of 5 = Disable



Industrial 2 of 5 = Enable

Industrial 2 of 5 Check Character Calculation

Enables/Disables calculation and verification of an optional Industrial 2 of 5 check character.

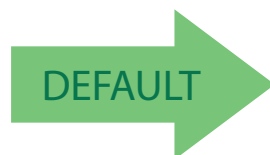

Industrial 2 of 5 Check Character Calculation = Disable



Industrial 2 of 5 Check Character Calculation = Enable

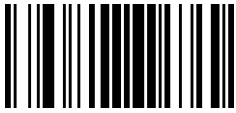

Industrial 2 of 5 Check Character Transmission

Enables/disables transmission of an Industrial 2 of 5 check character.

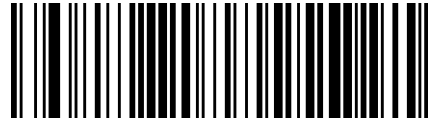

Industrial 2 of 5 Check Character Transmission = Disable

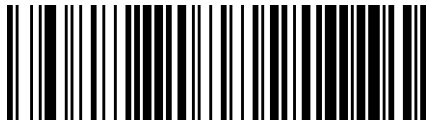

Industrial 2 of 5 Check Character Transmission = Enable



Industrial 2 of 5 Length Control

This feature specifies either variable length decoding or fixed length decoding for the Industrial 2 of 5 symbology.

Variable Length: For variable length decoding, a minimum and maximum length may be set.

Fixed Length: For fixed length decoding, two different lengths may be set.

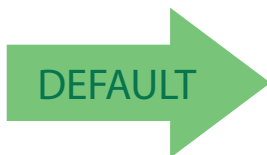

Industrial 2 of 5 Length Control = Variable Length



Industrial 2 of 5 Length Control = Fixed Length



Industrial 2 of 5 Set Length 1

This feature specifies one of the bar code lengths for **Industrial 2 of 5 Length Control**. Length 1 is the minimum label length if in **Variable Length Mode**, or the first fixed length if in **Fixed Length Mode**. Length includes the bar code's data characters only. The length can be set from 0 to 50 characters.

Table 12 provides some examples for setting Length 1. See page 297 if you want detailed instructions on setting this feature.

Table 12. Industrial 2 of 5 Length 1 Setting Examples

STEP	ACTION	EXAMPLES			
1	Desired Setting	00 Characters	07 Characters	15 Characters	50 Characters
2	Scan ENTER/EXIT PROGRAMMING MODE				
3	Scan SELECT INDUSTRIAL 2 OF 5 LENGTH 1 SETTING				
4	Scan Two Characters From Appendix D, Keypad	'0' and '0'	'0' and '7'	'1' and '5'	'5' AND '0'
5	Scan ENTER/EXIT PROGRAMMING MODE				



Select Industrial 2 of 5 Length 1 Setting

To configure this feature, scan the ENTER/EXIT bar code above, then the bar code at left followed by digits from the Alphanumeric characters in **Appendix D, Keypad** representing your desired character(s). End by scanning the ENTER/EXIT bar code again.

Make a mistake? Scan the CANCEL bar code to abort and not save the entry string. You can then start again at the beginning.



CANCEL

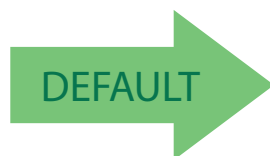

01 = Length 1 is 1 Character



Industrial 2 of 5 Set Length 2

This feature specifies one of the bar code lengths for **Industrial 2 of 5 Length Control**. Length 2 is the maximum label length if in **Variable Length Mode**, or the second fixed length if in **Fixed Length Mode**. Length includes the bar code's check, data, and full-ASCII shift characters. The length does not include start/stop characters.

The length can be set from 1 to 50 characters. A setting of 0 specifies to ignore this length (only one fixed length).

Table 13 provides examples for setting Length 2. See page 298 for detailed instructions on setting this feature.

Table 13. Industrial 2 of 5 Length 2 Setting Examples

STEP	ACTION	EXAMPLES			
1	Desired Setting	00 (Ignore This Length)	07 Characters	15 Characters	50 Characters
2	Scan ENTER/EXIT PROGRAMMING MODE				
3	Scan SELECT INDUSTRIAL 2 OF 5 LENGTH 2 SETTING				
4	Scan Two Characters From Appendix D, Keypad	'0' and '0'	'0' and '7'	'1' and '5'	'5' AND '0'
5	Scan ENTER/EXIT PROGRAMMING MODE				

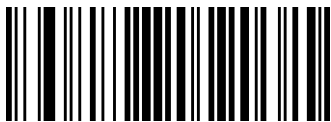

Select Industrial 2 of 5 Length 2 Setting

To configure this feature, scan the ENTER/EXIT bar code above, then the bar code at left followed by digits from the Alphanumeric characters in **Appendix D, Keypad** representing your desired character(s). End by scanning the ENTER/EXIT bar code again.

Make a mistake? Scan the CANCEL bar code to abort and not save the entry string. You can then start again at the beginning.



CANCEL

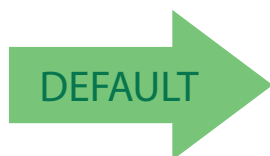

50 = Length 2 is 50 Characters



Industrial 2 of 5 Minimum Reads

This feature specifies the minimum number of consecutive times an Industrial 2 of 5 label must be decoded before it is accepted as good read.

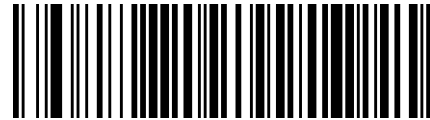
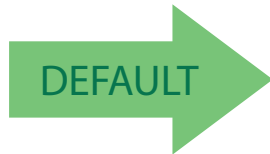

Industrial 2 of 5 Minimum Reads = 1



Industrial 2 of 5 Minimum Reads = 2



Industrial 2 of 5 Minimum Reads = 3



Industrial 2 of 5 Minimum Reads = 4

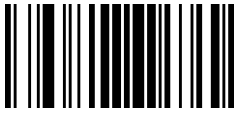

CODE IATA (ONLY STANDARD OPTIC MODELS)

This setting has no effect for AR models.
The following options apply to the IATA symbology.

IATA Enable/Disable

Enables/Disables the ability of the reader to decode IATA labels.

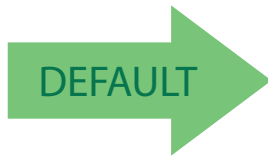

IATA = Disable



IATA = Enable

IATA Check Character Transmission

Enables/Disables calculation and verification of an optional Industrial 2 of 5 check character.

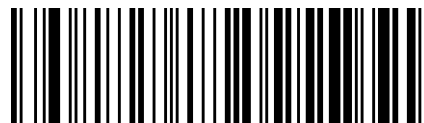

IATA Check Character Transmission = Disable



IATA Check Character Transmission = Enable





CODABAR

The following options apply to the Codabar symbology.

Codabar Enable/Disable

When disabled, the reader will not read Codabar bar codes.

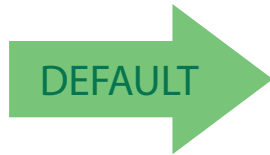

Codabar = Disable

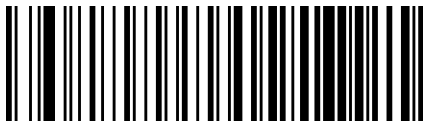

Codabar = Enable

Codabar Check Character Calculation

This setting has no effect for AR models.

Enable this option to enables/disables calculation and verification of an optional Codabar check character. When disabled, any check character in the label is treated as a data character

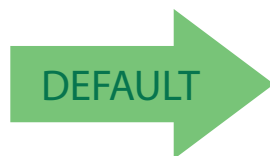

Codabar Check Character Calculation =
Don't Calculate



Codabar Check Character Calculation = Enable AIM standard
check char.



Codabar Check Character Calculation =
Enable Modulo 10 check char.

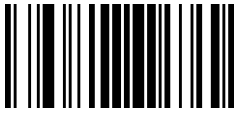

Codabar Check Character Transmission

This setting has no effect for AR models.

Enable this option to transmit the check character along with Codabar bar code data.

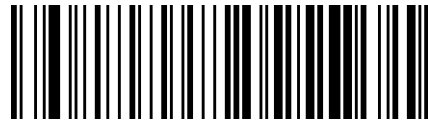

Codabar Check Character Transmission = Don't Send



Codabar Check Character Transmission = Send



Codabar Start/Stop Character Transmission

Enable this option to enable/disable transmission of Codabar start and stop characters.



Codabar Start/Stop Character Transmission =
Don't Transmit



Codabar Start/Stop Character Transmission = Transmit





Codabar Start/Stop Character Set

This option specifies the format of transmitted Codabar start/stop characters.



Codabar Check Character Set = ABCD/TN*E



Codabar Check Character Set = ABCD/ABCD



Codabar Check Character Set = abcd/tn*e



Codabar Check Character Set = abcd/abcd



Codabar Start/Stop Character Match

When enabled, this option requires that start and stop characters match.

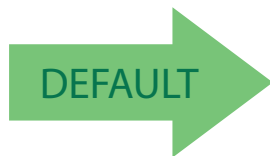

Codabar Start/Stop Character Match = Don't Require Match



Codabar Start/Stop Character Match = Require Match



Codabar Quiet Zones

This setting has no effect for AR models.

Specifies the number of quiet zones for Codabar labels. Quiet zones are blank areas at the ends of a bar code and are typically 10 times the width of the narrowest bar or space in the label.



Codabar Quiet Zones = Quiet Zone on one side



Codabar Quiet Zones = Quiet Zones on two sides



Codabar Quiet Zones = Auto



Codabar Quiet Zones = Virtual Quiet Zones on two sides



Codabar Quiet Zones = Small Quiet Zones on two sides



Codabar Minimum Reads

This setting has no effect for AR models.

This feature specifies the minimum number of consecutive times a Codabar label must be decoded before it is accepted as good read.

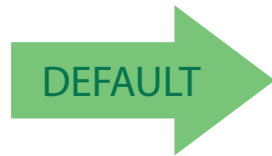

Codabar Minimum Reads = 1



Codabar Minimum Reads = 2



Codabar Minimum Reads = 3



Codabar Minimum Reads = 4

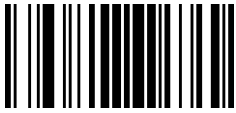

Codabar Decoding Levels

This setting has no effect for AR models.

Decoding Levels are used to configure a bar code symbology decoder to be very aggressive to very conservative depending on a particular customer's needs.



Codabar Decoding Level = Disable



Codabar Decoding Level = 1



Codabar Decoding Level = 2



Codabar Decoding Level = 3



Codabar Decoding Level = 4



Codabar Decoding Level = 5



Codabar Length Control

This feature specifies either variable length decoding or fixed length decoding for the Codabar symbology.

Variable Length. For variable length decoding, a minimum and maximum length may be set.

Fixed Length. For fixed length decoding, two different lengths may be set.

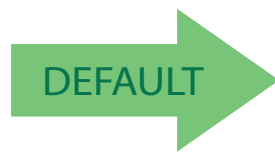

Codabar Length Control = Variable Length



Codabar Length Control = Fixed Length



Codabar Set Length 1

This feature specifies one of the bar code lengths for **Codabar Length Control**. Length 1 is the minimum label length if in **Variable Length Mode**, or the first fixed length if in **Fixed Length Mode**. Length includes the bar code’s start, stop, check and data characters. The length must include at least one data character. The length can be set from 3 to 50 characters.

Table 14 provides some examples for setting Length 1. See page 297 for detailed instructions on setting this feature.

Table 14. Codabar Length 1 Setting Examples

STEP	ACTION	EXAMPLES			
1	Desired Setting (and pad with leading zeroes)	03 Characters	09 Characters	15 Characters	50 Characters
2	Scan ENTER/EXIT PROGRAMMING MODE				
3	Scan SELECT CODABAR LENGTH 1 SETTING				
4	Scan Two Characters From Appendix D, Keypad	'0' and '3'	'0' and '9'	'1' and '5'	'5' AND '0'
5	Scan ENTER/EXIT PROGRAMMING MODE				

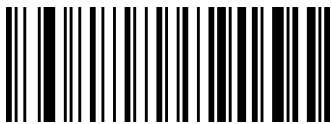

Select Codabar Length 1 Setting

To configure this feature, scan the ENTER/EXIT bar code above, then the bar code at left followed by digits from the Alphanumeric characters in **Appendix D, Keypad** representing your desired character(s). End by scanning the ENTER/EXIT bar code again.

Make a mistake? Scan the CANCEL bar code to abort and not save the entry string. You can then start again at the beginning.



CANCEL



03 = Length 1 is 3 Characters



Codabar Set Length 2

This feature specifies one of the bar code lengths for **Codabar Length Control**. Length 2 is the maximum label length if in **Variable Length Mode**, or the second fixed length if in **Fixed Length Mode**. The length includes the bar code's start, stop, check and data characters. The length must include at least one data character.

The length can be set from 3 to 50 characters. A setting of 0 specifies to ignore this length (only one fixed length).

Table 15 provides examples for setting Length 2. See page 298 for detailed instructions on setting this feature.

Table 15. Codabar Length 2 Setting Examples

STEP	ACTION	EXAMPLES			
1	Desired Setting (and pad with leading zeroes)	00 Ignore This Length	07 Characters	15 Characters	50 Characters
2	Scan ENTER/EXIT PROGRAMMING MODE				
3	Scan SELECT CODABAR LENGTH 2 SETTING				
4	Scan Two Characters From Appendix D, Keypad	'0' and '0'	'0' and '7'	'1' and '5'	'5' AND '0'
5	Scan ENTER/EXIT PROGRAMMING MODE				



Select Codabar Length 2 Setting

To configure this feature, scan the ENTER/EXIT bar code above, then the bar code at left followed by digits from the Alphanumeric characters in **Appendix D, Keypad** representing your desired character(s). End by scanning the ENTER/EXIT bar code again.

Make a mistake? Scan the CANCEL bar code to abort and not save the entry string. You can then start again at the beginning.



CANCEL

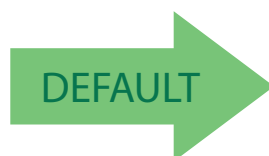

50 = Length 2 is 50 Characters

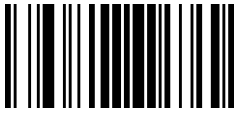

Codabar Interdigit Ratio

This setting has no effect for AR models.

This feature specifies the maximum ratio between an intercharacter space and module for Codabar labels.



Codabar Interdigit Ratio = Disable

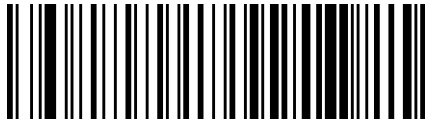

Codabar Interdigit Ratio = 1



Codabar Interdigit Ratio = 2



Codabar Interdigit Ratio = 3

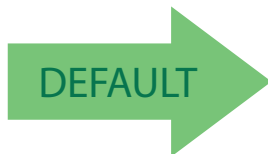

Codabar Interdigit Ratio = 4



Codabar Interdigit Ratio = 5



Codabar Interdigit Ratio (continued)



Codabar Interdigit Ratio = 6



Codabar Interdigit Ratio = 7



Codabar Interdigit Ratio = 8



Codabar Interdigit Ratio = 9



Codabar Interdigit Ratio = 10



ABC CODABAR

This setting has no effect for AR models.

The following options apply to the ABC Codabar symbology.

ABC Codabar Enable/Disable

Enables/Disables ability of scanner to decode ABC Codabar labels.

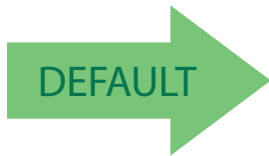

ABC Codabar = Disable

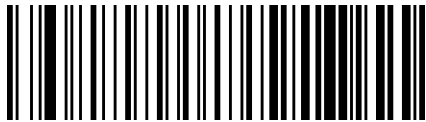

ABC Codabar = Enable

ABC Codabar Concatenation Mode

Specifies the concatenation mode between Static and Dynamic.

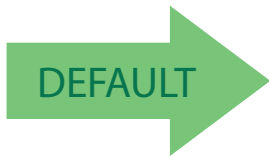

ABC Codabar Concatenation Mode = Static



ABC Codabar Concatenation Mode = Dynamic



ABC Codabar Dynamic Concatenation Timeout

This parameter specifies the timeout in 10-millisecond ticks used by the ABC Codabar Dynamic Concatenation Mode. The timeout can be set within a range of 05 to 255 in 10ms increments. A setting of zero specifies no delay.



Select ABC Codabar Dynamic Concatenation Timeout Setting

To configure this feature, scan the ENTER/EXIT bar code above, then the bar code at left followed by digits from the Alphanumeric characters in [Appendix D, Keypad](#) representing your desired character(s). End by scanning the ENTER/EXIT bar code again.

Make a mistake? Scan the CANCEL bar code to abort and not save the entry string. You can then start again at the beginning.

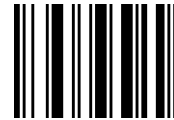

CANCEL

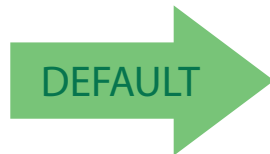

10 = Quiet Interval of 200 ms

ABC Codabar Force Concatenation

Forces labels starting or ending with D to be concatenated.

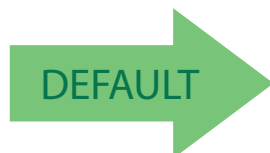

ABC Codabar Force Concatenation = Disable



ABC Codabar Force Concatenation = Enable

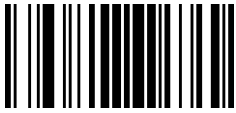

CODE 11 (ONLY STANDARD OPTIC MODELS)

This setting has no effect for AR models.

The following options apply to the Code 11 symbology.

Code 11 Enable/Disable

When disabled, the reader will not read Code 11 bar codes.

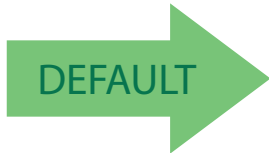

Code 11 = Disable

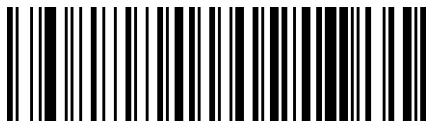

Code 11 = Enable

Code 11 Check Character Calculation

This option enables/disables calculation and verification of optional Code 11 check character.



Code 11 Check Character Calculation = Disable



Code 11 Check Character Calculation = Check C



Code 11 Check Character Calculation = Check K



Code 11 Check Character Calculation = Check C and K





Code 11 Check Character Transmission

This feature enables/disables transmission of an optional Code 11 check character.



Code 11 Check Character Transmission = Don't Send



Code 11 Check Character Transmission = Send



Code 11 Minimum Reads

This feature specifies the minimum number of consecutive times a Code 11 label must be decoded before it is accepted as good read.



Code 11 Minimum Reads = 1



Code 11 Minimum Reads = 2



Code 11 Minimum Reads = 3



Code 11 Minimum Reads = 4



Code 11 Length Control

This feature specifies either variable length decoding or fixed length decoding for the Code 11 symbology.

Variable Length. For variable length decoding, a minimum and maximum length may be set.

Fixed Length. For fixed length decoding, two different lengths may be set.

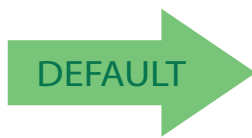

Code 11 Length Control = Variable Length



Code 11 Length Control = Fixed Length



Code 11 Set Length 1

This feature specifies one of the bar code lengths for **Code 11 Length Control**. Length 1 is the minimum label length if in **Variable Length Mode**, or the first fixed length if in **Fixed Length Mode**. Length includes the bar code's check and data characters. The length can be set from 2 to 50 characters.

Table 16 provides some examples for setting Length 1. See page 297 for detailed instructions on setting this feature.

Table 16. Code 11 Length 1 Setting Examples

STEP	ACTION	EXAMPLES			
1	Desired Setting (pad with leading zeroes)	02 Characters	07 Characters	15 Characters	50 Characters
2	Scan ENTER/EXIT PROGRAMMING MODE				
3	Scan SELECT CODE 11 LENGTH 1 SETTING				
4	Scan Two Characters From Appendix D, Keypad	'0' and '2'	'0' and '7'	'1' and '5'	'5' AND '0'
5	Scan ENTER/EXIT PROGRAMMING MODE				



Select Code 11 Length 1 Setting

To configure this feature, scan the ENTER/EXIT bar code above, then the bar code at left followed by digits from the Alphanumeric characters in **Appendix D, Keypad** representing your desired character(s). End by scanning the ENTER/EXIT bar code again.

Make a mistake? Scan the CANCEL bar code to abort and not save the entry string. You can then start again at the beginning.



CANCEL



04 = Length 1 is 4 Characters



Code 11 Set Length 2

This feature specifies one of the bar code lengths for Code 11 Length Control. Length 2 is the maximum label length if in Variable Length Mode, or the second fixed length if in Fixed Length Mode. Length includes the bar code's check and data characters.

The length can be set from 2 to 50 characters. A setting of 0 specifies to ignore this length (only one fixed length).

Table 17 provides examples for setting Length 2. See page 298 for detailed instructions on setting this feature.

Table 17. Code 11 Length 2 Setting Examples

STEP	ACTION	EXAMPLES			
1	Desired Setting (pad with leading zeroes)	00 (Ignore This Length)	07 Characters	15 Characters	50 Characters
2	Scan ENTER/EXIT PROGRAMMING MODE				
3	Scan SELECT CODE 11 LENGTH 2 SETTING				
4	Scan Two Characters From Appendix D, Keypad	'0' and '0'	'0' and '7'	'1' and '5'	'5' and '0'
5	Scan ENTER/EXIT PROGRAMMING MODE				



Select Code 11 Length 2 Setting

To configure this feature, scan the ENTER/EXIT bar code above, then the bar code at left followed by digits from the Alphanumeric characters in Appendix D, Keypad representing your desired character(s). End by scanning the ENTER/EXIT bar code again.

Make a mistake? Scan the CANCEL bar code to abort and not save the entry string. You can then start again at the beginning.



CANCEL

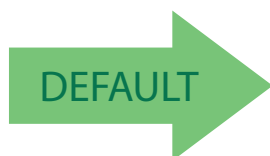

50 = Length 2 is 50 Characters

Code 11 Interdigit Ratio

This feature specifies the ratio between an intercharacter space and module for Code 11 labels.

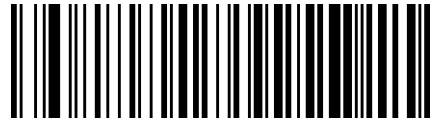

Code 11 Interdigit Ratio = Disable



Code 11 Interdigit Ratio = 1



Code 11 Interdigit Ratio = 2



Code 11 Interdigit Ratio = 3



Code 11 Interdigit Ratio = 4



Code 11 Interdigit Ratio = 5

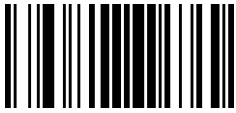

Code 11 Interdigit Ratio (continued)



Code 11 Interdigit Ratio = 6



Code 11 Interdigit Ratio = 7



Code 11 Interdigit Ratio = 8

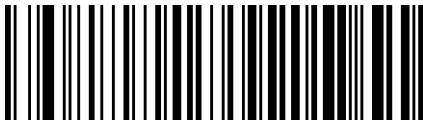

Code 11 Interdigit Ratio = 9



Code 11 Interdigit Ratio = 10



Code 11 Decoding Levels

Decoding Levels are used to configure a bar code symbology decoder to be very aggressive to very conservative depending on a particular customer's needs.



Code 11 Decoding Level = Disable

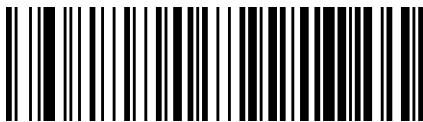

Code 11 Decoding Level = 1

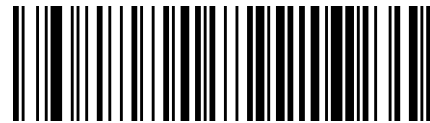

Code 11 Decoding Level = 2



Code 11 Decoding Level = 3



Code 11 Decoding Level = 4



Code 11 Decoding Level = 5

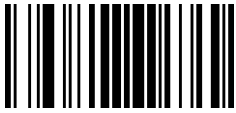

GS1 DATABAR™ OMNIDIRECTIONAL

The following options apply to the GS1 DataBar™ Omnidirectional (formerly RSS-14) symbology.

GS1 DataBar™ Omnidirectional Enable/Disable

When disabled, the reader will not read GS1 DataBar™ Omnidirectional bar codes.

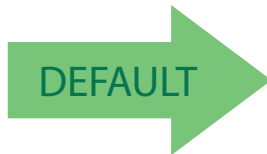

GS1 DataBar™ Omnidirectional = Disable



GS1 DataBar™ Omnidirectional = Enable

GS1 DataBar™ Omnidirectional GS1-128 Emulation

When enabled, GS1 DataBar™ Omnidirectional bar codes will be translated to the GS1-128 label data format.

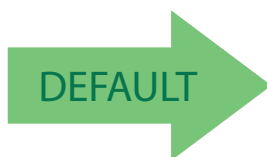

GS1 DataBar™ Omnidirectional GS1-128 Emulation = Disable



GS1 DataBar™ Omnidirectional GS1-128 Emulation = Enable



GS1 DataBar™ Omnidirectional Minimum Reads

This setting has no effect for AR models.

This feature specifies the minimum number of consecutive times a GS1 DataBar Omnidirectional label must be decoded before it is accepted as good read.

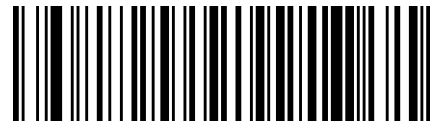
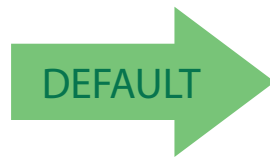

GS1 DataBar Omnidirectional Minimum Reads = 1

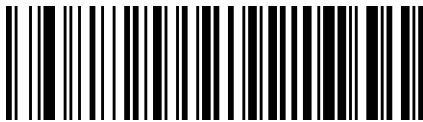

GS1 DataBar Omnidirectional Minimum Reads = 2



GS1 DataBar Omnidirectional Minimum Reads = 3



GS1 DataBar Omnidirectional Minimum Reads = 4



GS1 DATABAR™ EXPANDED

The following options apply to the GS1 DataBar™ Expanded (formerly RSS Expanded) symbology.

GS1 DataBar™ Expanded Enable/Disable

When disabled, the reader will not read GS1 DataBar™ Expanded bar codes.

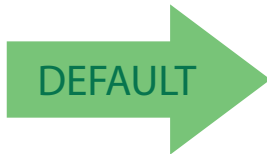

GS1 DataBar™ Expanded = Disable

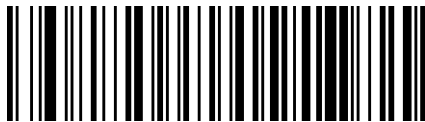

GS1 DataBar™ Expanded = Enable

GS1 DataBar™ Expanded GS1-128 Emulation

When enabled, GS1 DataBar™ Expanded bar codes will be translated to the GS1-128 label data format.

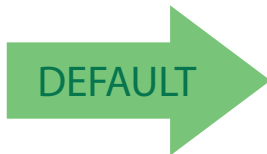

GS1 DataBar™ Expanded GS1-128 Emulation = Disable



GS1 DataBar™ Expanded GS1-128 Emulation = Enable



GS1 DataBar™ Expanded Minimum Reads

This setting has no effect for AR models.

This feature specifies the minimum number of consecutive times a GS1 DataBar Expanded label must be decoded before it is accepted as good read.

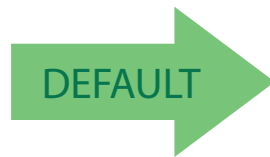

GS1 DataBar Expanded Minimum Reads = 1



GS1 DataBar Expanded Minimum Reads = 2



GS1 DataBar Expanded Minimum Reads = 3



GS1 DataBar Expanded Minimum Reads = 4



GS1 DataBar™ Expanded Length Control

This feature specifies either variable length decoding or fixed length decoding for the GS1 DataBar™ Expanded symbology.

Variable Length: For variable-length decoding, a minimum length may be set.

Fixed Length: For fixed-length decoding, two different lengths may be set.

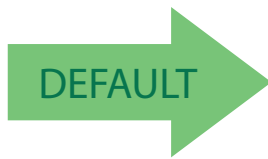

GS1 DataBar™ Expanded Length Control =
Variable Length



GS1 DataBar™ Expanded Length Control = Fixed Length



GS1 DataBar™ Expanded Set Length 1

This feature specifies one of the bar code lengths for GS1 DataBar™ Expanded Length Control. Length 1 is the minimum label length if in Variable Length Mode, or the first fixed length if in Fixed Length Mode. Length includes the bar code’s data characters only. The length can be set from 1 to 74 characters.

Table 18 provides some examples for setting Length 1. See page 297 for detailed instructions on setting this feature.

Table 18. GS1 DataBar™ Expanded Length 1 Setting Examples

STEP	ACTION	EXAMPLES			
1	Desired Setting	01 Character	07 Characters	52 Characters	74 Characters
2	Scan ENTER/EXIT PROGRAMMING MODE				
3	Scan SELECT GS1 DataBar™ EXPANDED LENGTH 1SETTING				
4	Scan Two Characters From Appendix D, Keypad	'0' and '1'	'0' and '7'	'5' and '2'	'7' AND '4'
5	Scan ENTER/EXIT PROGRAMMING MODE				



Select GS1 DataBar™ Expanded Length 1 Setting

To configure this feature, scan the ENTER/EXIT bar code above, then the bar code at left followed by digits from the Alphanumeric characters in Appendix D, Keypad representing your desired character(s). End by scanning the ENTER/EXIT bar code again.

Make a mistake? Scan the CANCEL bar code to abort and not save the entry string. You can then start again at the beginning.



CANCEL

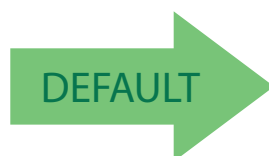

01 = Length 1 is 1 Character



GS1 DataBar™ Expanded Set Length 2

This feature specifies one of the bar code lengths for GS1 DataBar™ Expanded Length Control. Length 2 is the maximum label length if in Variable Length Mode, or the second fixed length if in Fixed Length Mode. Length includes the bar code’s data characters only. The length can be set from 1 to 74 characters. A setting of 0 specifies to ignore this length (only one fixed length).

Table 19 provides examples for setting Length 2. See page 298 for detailed instructions on setting this feature.

Table 19. GS1 DataBar™ Expanded Length 2 Setting Examples

STEP	ACTION	EXAMPLES			
1	Desired Setting	00 (ignore second length)	07 Characters	52 Characters	74 Characters
2	Scan ENTER/EXIT PROGRAMMING MODE				
3	Scan SELECT GS1 DataBar™ EXPANDED LENGTH 2 SETTING				
4	Scan Two Characters From Appendix D, Keypad	'0' and '0'	'0' and '7'	'5' and '2'	'7' and '4'
5	Scan ENTER/EXIT PROGRAMMING MODE				



Select GS1 DataBar™ Expanded Length 2 Setting

To configure this feature, scan the ENTER/EXIT bar code above, then the bar code at left followed by digits from the Alphanumeric characters in Appendix D, Keypad representing your desired character(s). End by scanning the ENTER/EXIT bar code again.

Make a mistake? Scan the CANCEL bar code to abort and not save the entry string. You can then start again at the beginning.



CANCEL

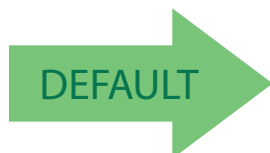

74 = Length 2 is 74 Characters



GS1 DATABAR™ LIMITED

The following options apply to the GS1 DataBar™ Limited (formerly RSS Limited) symbology.

GS1 DataBar™ Limited Enable/Disable

When disabled, the reader will not read GS1 DataBar™ Limited bar codes.

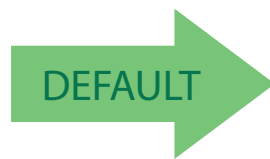

GS1 DataBar™ Limited = Disable



GS1 DataBar™ Limited = Enable

GS1 DataBar™ Limited GS1-128 Emulation

When enabled, GS1 DataBar™ Limited bar codes will be translated to the GS1-128 label data format.

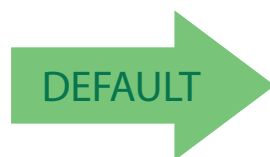

GS1 DataBar™ Limited GS1-128 Emulation = Disable



GS1 DataBar™ Limited GS1-128 Emulation = Enable



GS1 DataBar™ Limited Minimum Reads

This setting has no effect for AR models.

This feature specifies the minimum number of consecutive times a GS1 DataBar Limited label must be decoded before it is accepted as good read.

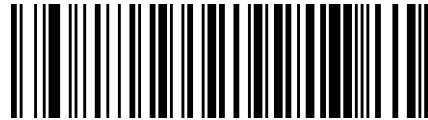
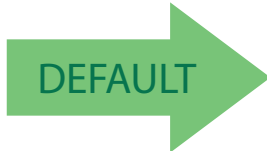

GS1 DataBar Limited Minimum Reads = 1

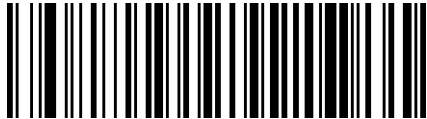

GS1 DataBar Limited Minimum Reads = 2



GS1 DataBar Limited Minimum Reads = 3



GS1 DataBar Limited Minimum Reads = 4



CODE 93

The following options apply to the Code 93 symbology.

Code 93 Enable/Disable

Enables/Disables ability of reader to decode Code 93 labels.

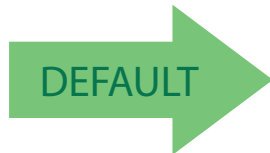

Code 93 = Disable

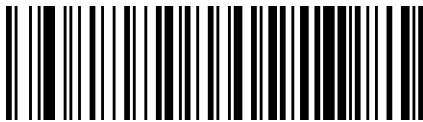

Code 93 = Enable

Code 93 Check Character Calculation

This setting has no effect for AR models.

Enables/disables calculation and verification of an optional Code 93 check character.



Code 93 Check Character Calculation = Disable



Code 93 Check Character Calculation = Enable Check C



Code 93 Check Character Calculation = Enable Check K



Code 93 Check Character Calculation =
Enable Check C and K



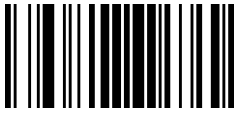

Code 93 Check Character Transmission

This setting has no effect for AR models.

Enables/disables transmission of an optional Code 93 check character.



Code 93 Check Character Transmission = Disable

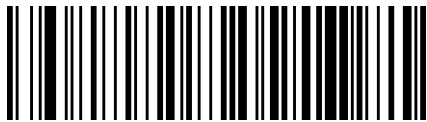

Code 93 Check Character Transmission = Enable



Code 93 Length Control

This feature specifies either variable length decoding or fixed length decoding for the Code 93 symbology.

Variable Length: For variable length decoding, a minimum and maximum length may be set.

Fixed Length: For fixed length decoding, two different lengths may be set.

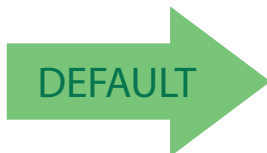

Code 93 Length Control = Variable Length



Code 93 Length Control = Fixed Length



Code 93 Set Length 1

Specifies one of the bar code lengths for **Code 93 Length Control**. Length 1 is the minimum label length if in **Variable Length Mode**, or the first fixed length if in **Fixed Length Mode**. Length includes the bar code's data characters only. The length can be set from 01 to 50 characters.

Table 20 provides some examples for setting Length 1. See page 297 for detailed instructions on setting this feature.

Table 20. Code 93 Length 1 Setting Examples

STEP	ACTION	EXAMPLES			
1	Desired Setting	01 Characters	07 Characters	15 Characters	50 Characters
2	Scan ENTER/EXIT PROGRAMMING MODE				
3	Scan SELECT CODE 93 LENGTH 1 SETTING				
4	Scan Two Characters From Appendix D, Keypad	'0' and '1'	'0' and '7'	'1' and '5'	'5' AND '0'
5	Scan ENTER/EXIT PROGRAMMING MODE				



Select Code 93 Length 1 Setting

To configure this feature, scan the ENTER/EXIT bar code above, then the bar code at left followed by digits from the Alphanumeric characters in **Appendix D, Keypad** representing your desired character(s). End by scanning the ENTER/EXIT bar code again.

Make a mistake? Scan the CANCEL bar code to abort and not save the entry string. You can then start again at the beginning.



CANCEL

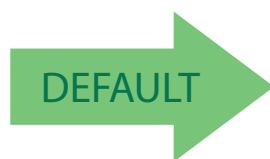

01 = Length 1 is 1 Character



Code 93 Set Length 2

This feature specifies one of the bar code lengths for **Code 93 Length Control**. Length 2 is the maximum label length if in **Variable Length Mode**, or the second fixed length if in **Fixed Length Mode**. Length includes the bar code's check, data, and full-ASCII shift characters. The length does not include start/stop characters. The length can be set from 1 to 50 characters. A setting of 0 specifies to ignore this length (only one fixed length).

Table 21 provides examples for setting Length 2. See page 298 for detailed instructions on setting this feature.

Table 21. CODE 93 Length 2 Setting Examples

STEP	ACTION	EXAMPLES			
1	Desired Setting	00 (Ignore This Length)	07 Characters	15 Characters	50 Characters
2	Scan ENTER/EXIT PROGRAMMING MODE				
3	Scan SELECT CODE 93 LENGTH 2 SETTING				
4	Scan Two Characters From Appendix D, Keypad	'0' and '0'	'0' and '7'	'1' and '5'	'5' AND '0'
5	Scan ENTER/EXIT PROGRAMMING MODE				

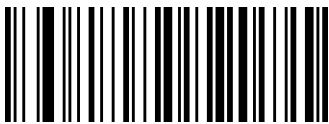

Select Code 93 Length 2 Setting

To configure this feature, scan the ENTER/EXIT bar code above, then the bar code at left followed by digits from the Alphanumeric characters in **Appendix D, Keypad** representing your desired character(s). End by scanning the ENTER/EXIT bar code again.

Make a mistake? Scan the CANCEL bar code to abort and not save the entry string. You can then start again at the beginning.



CANCEL

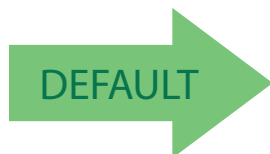

50 = Length 2 is 50 Characters



Code 93 Minimum Reads

This setting has no effect for AR models.

This feature specifies the minimum number of consecutive times a Code 93 label must be decoded before it is accepted as good read.

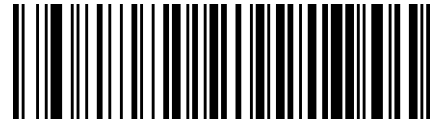
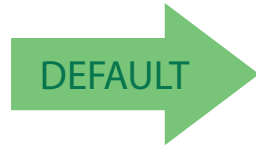

Code 93 Minimum Reads = 1



Code 93 Minimum Reads = 2



Code 93 Minimum Reads = 3



Code 93 Minimum Reads = 4

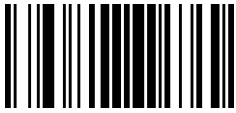

Code 93 Decoding Levels

This setting has no effect for AR models.

Decoding Levels are used to configure a bar code symbology decoder to be very aggressive to very conservative depending on a particular customer's needs.



Code 93 Decoding Level = Disable



Code 93 Decoding Level = 1

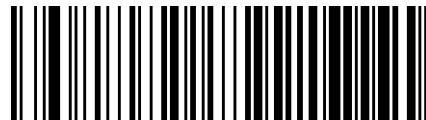

Code 93 Decoding Level = 2



Code 93 Decoding Level = 3



Code 93 Decoding Level = 4



Code 93 Decoding Level = 5



Code 93 Quiet Zones

This setting has no effect for AR models.
Enables/disables quiet zones for Code 93.

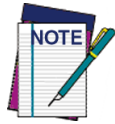

This feature is available only on the TD1130 model.



Code 93 Quiet Zones = No Quiet Zones

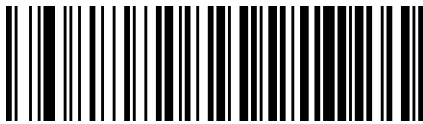

Code 93 Quiet Zones = Quiet Zone on one side



Code 93 Quiet Zones = Quiet Zones on two sides



Code 93 Quiet Zones = Auto



Code 93 Quiet Zones = Virtual Quiet Zones on two sides

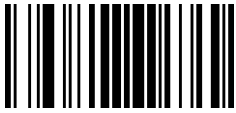

CODABLOCK F

This setting has no effect for AR models.

The following options apply to the Codablock F symbology.

Codablock F Enable/Disable

Enables/Disables ability of reader to decode Codablock F labels.

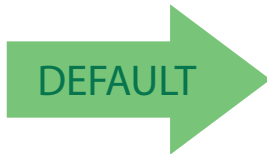

Codablock F = Disable



Codablock F = Enable

Codablock F EAN Enable/Disable

This setting has no effect for AR models.

Enables/Disables the Codablock F EAN subtype (code with FNC1 in the first position).

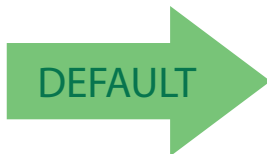

Codablock F EAN = Disable



Codablock F EAN = Enable



Codablock F AIM Check

This setting has no effect for AR models.

Specifies if Check Digit calculation algorithm is AIM compliant or not.



Codablock F AIM Check = Not AIM compliant

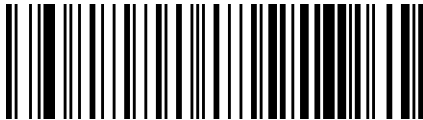

Codablock F AIM Check = AIM compliant



Codablock F Length Control

This feature specifies either variable length decoding or fixed length decoding for the Codablock F symbology.

Variable Length. For variable length decoding, a minimum and maximum length may be set.

Fixed Length. For fixed length decoding, two different lengths may be set.

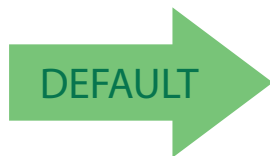

Codablock F Length Control = Variable Length



Codablock F Length Control = Fixed Length



Codablock F Set Length 1

This feature specifies one of the bar code lengths for Codablock F Length Control. Length 1 is the minimum label length if in Variable Length Mode, or the first fixed length if in Fixed Length Mode. Length includes the bar code's data characters only.

The length can be set from 003 to 255 characters. See [Set Length 1 on page 297](#) for more detailed programming instructions.

Table 22. Codablock F Length 1 Setting Examples

STEP	ACTION	EXAMPLES			
1	Desired Setting	01 Characters	07 Characters	15 Characters	50 Characters
2	Scan ENTER/EXIT PROGRAMMING MODE				
3	Scan SELECT CODE 93 LENGTH 1 SETTING				
4	Scan Two Characters From Appendix D, Keypad	'0' and '1'	'0' and '7'	'1' and '5'	'5' AND '0'
5	Scan ENTER/EXIT PROGRAMMING MODE				



Select Codablock F Length 1 Setting

To configure this feature, scan the ENTER/EXIT bar code above, then the bar code at left followed by digits from the Alphanumeric characters in [Appendix D, Keypad](#) representing your desired character(s). End by scanning the ENTER/EXIT bar code again.

Make a mistake? Scan the CANCEL bar code to abort and not save the entry string. You can then start again at the beginning.

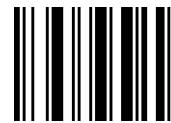

CANCEL



003 = Length 1 is 3 Characters



Codablock F Set Length 2

This feature specifies one of the bar code lengths for Codablock F Length Control. Length 2 is the maximum label length if in Variable Length Mode, or the second fixed length if in Fixed Length Mode. Length includes the bar code's check, data, and full-ASCII shift characters. The length does not include start/stop characters.

The length can be set from 3 to 255 characters. A setting of 00 specifies to ignore this length (only one fixed length). See [Set Length 2 on page 298](#) for more detailed programming instructions.

Table 23. Codablock F Length 1 Setting Examples

STEP	ACTION	EXAMPLES			
1	Desired Setting	01 Characters	07 Characters	15 Characters	50 Characters
2	Scan ENTER/EXIT PROGRAMMING MODE				
3	Scan SELECT CODE 93 LENGTH 1 SETTING				
4	Scan Two Characters From Appendix D, Keypad	'0' and '1'	'0' and '7'	'1' and '5'	'5' AND '0'
5	Scan ENTER/EXIT PROGRAMMING MODE				

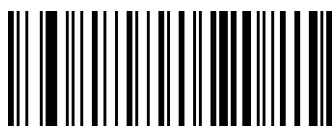

Select Codablock F Length 2 Setting

To configure this feature, scan the ENTER/EXIT bar code above, then the bar code at left followed by digits from the Alphanumeric characters in [Appendix D, Keypad](#) representing your desired character(s). End by scanning the ENTER/EXIT bar code again.

Make a mistake? Scan the CANCEL bar code to abort and not save the entry string. You can then start again at the beginning.



CANCEL

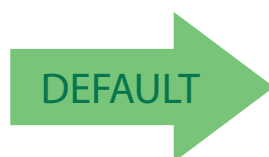

100 = Length 2 is 100 Characters

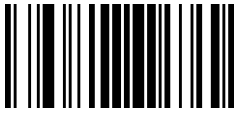

CODE 4

This setting has no effect for AR models.
The following options apply to the Code 4 symbology.

Code 4 Enable/Disable

Enables/Disables ability of reader to decode Code 4 labels.

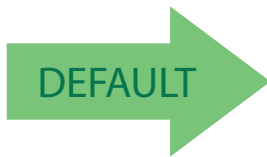

Code 4 = Disable



Code 4 = Enable

Code 4 Check Character Transmission

This feature enables/disables transmission of an optional Code 4 check character.



Code 4 Check Character Transmission = Don't Send



Code 4 Check Character Transmission = Send





Code 4 Hex to Decimal Conversion

This feature enables/disables the conversion of hexadecimal label data to decimal label data.

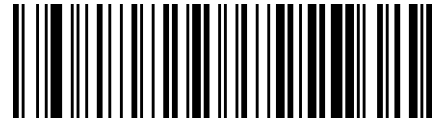

Code 4 Hex to Decimal Conversion = Disable

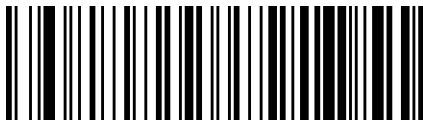

Code 4 Hex to Decimal Conversion = Enable



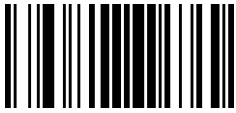

CODE 5

This setting has no effect for AR models.
The following options apply to the Code 5 symbology.

Code 5 Enable/Disable

Enables/Disables ability of reader to decode Code 5 labels.

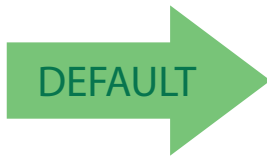

Code 5 = Disable



Code 5 = Enable

Code 5 Check Character Transmission

This feature enables/disables transmission of an optional Code 5 check character.



Code 5 Check Character Transmission = Don't Send



Code 5 Check Character Transmission = Send





Code 5 Hex to Decimal Conversion

This feature enables/disables the conversion of hexadecimal label data to decimal label data.

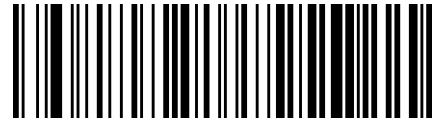

Code 5 Hex to Decimal Conversion = Disable

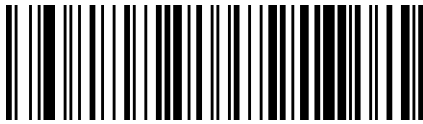

Code 5 Hex to Decimal Conversion = Enable





CODE 4 AND CODE 5 COMMON CONFIGURATION ITEMS

The following options apply to both Code 4 and Code 5 symbologies.

Code 4 and 5 Decoding Levels

This setting has no effect for AR models.

Decoding Levels are used to configure a bar code symbology decoder to be very aggressive to very conservative depending on a particular customer's needs.



This configuration item applies to Code 4 and Code 5.

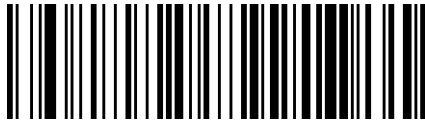

Code 4 and Code 5 Decoding Level = 1



Code 4 and Code 5 Decoding Level = 2



Code 4 and Code 5 Decoding Level = 3

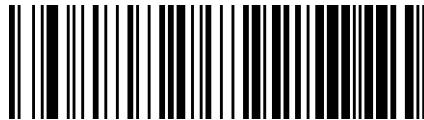

Code 4 and Code 5 Decoding Level = 4



Code 4 and Code 5 Decoding Level = 5



Code 4 and Code 5 Minimum Reads

This feature specifies the minimum number of consecutive times a Code 4 or Code 5 label must be decoded before it is accepted as good read

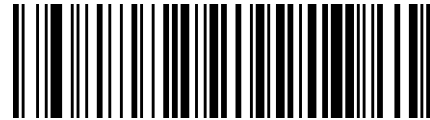
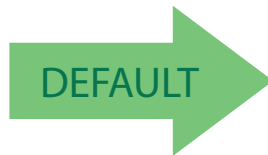

Code 4 or Code 5 Minimum Reads = 1



Code 4 or Code 5 Minimum Reads = 2



Code 4 or Code 5 Minimum Reads = 3



Code 4 or Code 5 Minimum Reads = 4



BC412

This setting has no effect for AR models.
The following options apply to the BC412 symbology.

BC412 Enable/Disable

Enables/Disables ability of scanner to decode BC412 labels.

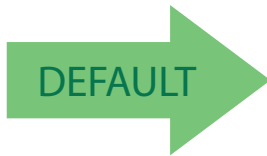

BC412 = Disable

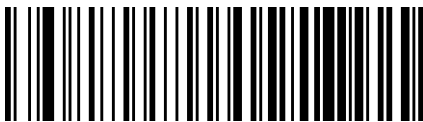

BC412 = Enable

BC412 Check Character Calculation

Enable this option to enable/disable calculation and verification of an optional BC412 check character. When disabled, any check character in the label is treated as a data character

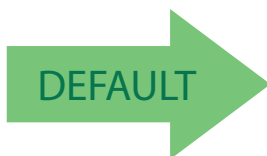

BC412 Check Character Calculation = Don't Calculate



BC412 Check Character Calculation = Calculate Check Character



BC412 Minimum Reads

This feature specifies the minimum number of consecutive times a BC412 label must be decoded before it is accepted as good read.

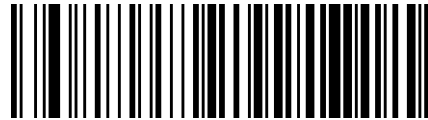
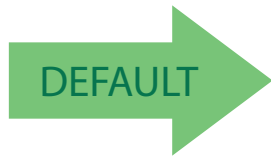

BC412 Minimum Reads = 1



BC412 Minimum Reads = 2

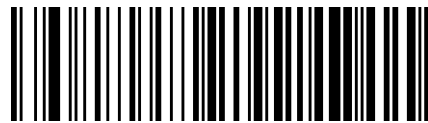

BC412 Minimum Reads = 3

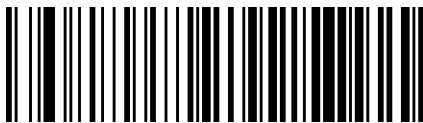

BC412 Minimum Reads = 4

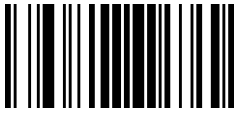

BC412 Decoding Levels

Decoding Levels are used to configure a bar code symbology decoder to be very aggressive to very conservative depending on a particular customer's needs.

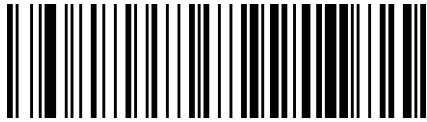

BC412 Decoding Level = 1

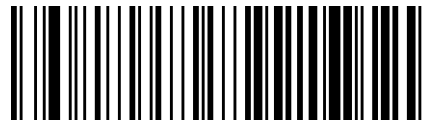

BC412 Decoding Level = 2

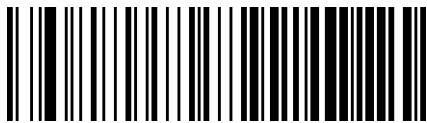

BC412 Decoding Level = 3



BC412 Decoding Level = 4



BC412 Decoding Level = 5



BC412 Length Control

This feature specifies either variable length decoding or fixed length decoding for the BC412 symbology.

Variable Length. For variable length decoding, a minimum and maximum length may be set.

Fixed Length. For fixed length decoding, two different lengths may be set.

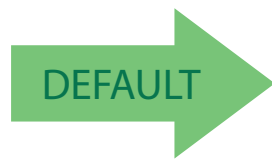

BC412 Length Control = Variable Length

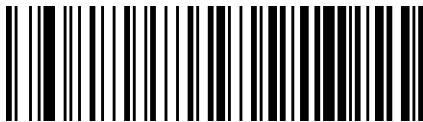

BC412 Length Control = Fixed Length



BC412 Set Length 1

This feature specifies one of the bar code lengths for BC412 Length Control. Length 1 is the minimum label length if in Variable Length Mode, or the first fixed length if in Fixed Length Mode. Length includes the bar code's check and data characters. The length can be set from 2 to 50 characters.

Table 16 provides some examples for setting Length 1. See page 297 for detailed instructions on setting this feature.

Table 24. BC412 Length 1 Setting Examples

STEP	ACTION	EXAMPLES			
1	Desired Setting (pad with leading zeroes)	02 Characters	07 Characters	15 Characters	50 Characters
2	Scan ENTER/EXIT PROGRAMMING MODE				
3	Scan SELECT CODE 11 LENGTH 1 SETTING				
4	Scan Two Characters From Appendix D, Keypad	'0' and '2'	'0' and '7'	'1' and '5'	'5' AND '0'
5	Scan ENTER/EXIT PROGRAMMING MODE				



Select BC412 Length 1 Setting

To configure this feature, scan the ENTER/EXIT bar code above, then the bar code at left followed by digits from the Alphanumeric characters in Appendix D, Keypad representing your desired character(s). End by scanning the ENTER/EXIT bar code again.

Make a mistake? Scan the CANCEL bar code to abort and not save the entry string. You can then start again at the beginning.



CANCEL

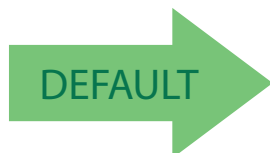

04 = Length 1 is 4 Characters



BC412 Set Length 2

This feature specifies one of the bar code lengths for **BC412 Length Control**. Length 2 is the maximum label length if in **Variable Length Mode**, or the second fixed length if in **Fixed Length Mode**. Length includes the bar code's check and data characters.

The length can be set from 2 to 50 characters. A setting of 0 specifies to ignore this length (only one fixed length).

Table 17 provides examples for setting Length 2. See [page 298](#) for detailed instructions on setting this feature.

Table 25. BC412 Length 2 Setting Examples

STEP	ACTION	EXAMPLES			
1	Desired Setting (pad with leading zeroes)	00 (Ignore This Length)	07 Characters	15 Characters	50 Characters
2	Scan ENTER/EXIT PROGRAMMING MODE				
3	Scan SELECT CODE 11 LENGTH 2 SETTING				
4	Scan Two Characters From Appendix D, Keypad	'0' and '0'	'0' and '7'	'1' and '5'	'5' and '0'
5	Scan ENTER/EXIT PROGRAMMING MODE				

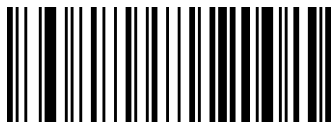

Select BC412 Length 2 Setting

To configure this feature, scan the ENTER/EXIT bar code above, then the bar code at left followed by digits from the Alphanumeric characters in **Appendix D, Keypad** representing your desired character(s). End by scanning the ENTER/EXIT bar code again.

Make a mistake? Scan the CANCEL bar code to abort and not save the entry string. You can then start again at the beginning.



CANCEL

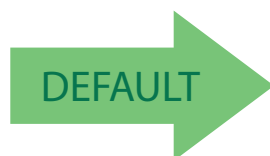

50 = Length 2 is 50 Characters

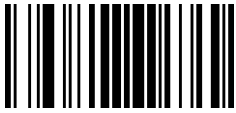

MSI

The following options apply to the MSI symbology.

MSI Enable/Disable

Enables/Disables ability of reader to decode MSI labels.

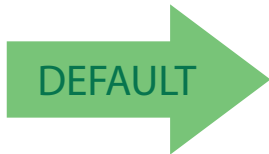

MSI = Disable

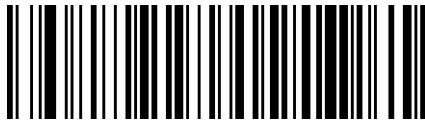

MSI = Enable

MSI Check Character Calculation

Enables/Disables calculation and verification of an optional MSI check character.

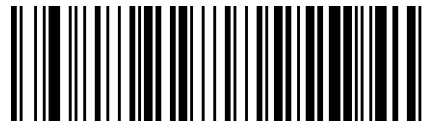

MSI Check Character Calculation = Disable



MSI Check Character Calculation = Enable Mod10



MSI Check Character Calculation = Enable Mod11/10



MSI Check Character Calculation = Enable Mod10/10



MSI Check Character Transmission

Enables/disables transmission of an MSI check character.



MSI Check Character Transmission = Disable

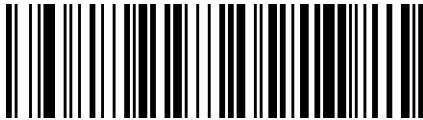

MSI Check Character Transmission = Enable



MSI Length Control

This feature specifies either variable length decoding or fixed length decoding for the MSI symbology.

Variable Length: For variable length decoding, a minimum and maximum length may be set.

Fixed Length: For fixed length decoding, two different lengths may be set.

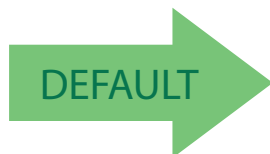

MSI Length Control = Variable Length



MSI Length Control = Fixed Length



MSI Set Length 1

This feature specifies one of the bar code lengths for **MSI Length Control**. Length 1 is the minimum label length if in **Variable Length Mode**, or the first fixed length if in **Fixed Length Mode**. Length includes the bar code's data characters only. The length can be set from 01 to 50 characters.

Table 26 provides some examples for setting Length 1. See page 297 for detailed instructions on setting this feature.

Table 26. MSI Length 1 Setting Examples

STEP	ACTION	EXAMPLES			
1	Desired Setting	01 Characters	07 Characters	15 Characters	50 Characters
2	Scan ENTER/EXIT PROGRAMMING MODE				
3	Scan SELECT MSI LENGTH 1 SETTING				
4	Scan Two Characters From Appendix D, Keypad	'0' and '1'	'0' and '7'	'1' and '5'	'5' AND '0'
5	Scan ENTER/EXIT PROGRAMMING MODE				



Select MSI Length 1 Setting

To configure this feature, scan the ENTER/EXIT bar code above, then the bar code at left followed by digits from the Alphanumeric characters in **Appendix D, Keypad** representing your desired character(s). End by scanning the ENTER/EXIT bar code again.

Make a mistake? Scan the CANCEL bar code to abort and not save the entry string. You can then start again at the beginning.



CANCEL

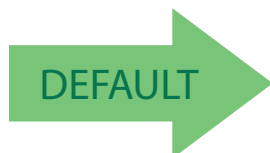

01 = Length 1 is 1 Character



MSI Set Length 2

This feature specifies one of the bar code lengths for **MSI Length Control**. Length 2 is the maximum label length if in **Variable Length Mode**, or the second fixed length if in **Fixed Length Mode**. Length includes the bar code's check, data, and full-ASCII shift characters. The length does not include start/stop characters.

The length can be set from 1 to 50 characters. A setting of 0 specifies to ignore this length (only one fixed length).

Table 27 provides examples for setting Length 2. See page 298 for detailed instructions on setting this feature.

Table 27. MSI Length 2 Setting Examples

STEP	ACTION	EXAMPLES			
1	Desired Setting	00 (Ignore This Length)	07 Characters	15 Characters	50 Characters
2	Scan ENTER/EXIT PROGRAMMING MODE				
3	Scan SELECT MSI LENGTH 2 SETTING				
4	Scan Two Characters From Appendix D, Keypad	'0' and '0'	'0' and '7'	'1' and '5'	'5' AND '0'
5	Scan ENTER/EXIT PROGRAMMING MODE				

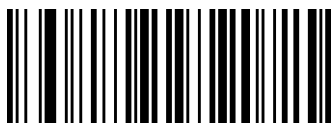

Select MSI Length 2 Setting

To configure this feature, scan the ENTER/EXIT bar code above, then the bar code at left followed by digits from the Alphanumeric characters in **Appendix D, Keypad** representing your desired character(s). End by scanning the ENTER/EXIT bar code again.

Make a mistake? Scan the CANCEL bar code to abort and not save the entry string. You can then start again at the beginning.



CANCEL

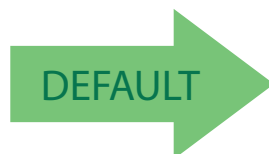

50 = Length 2 is 50 Characters

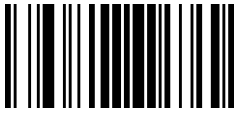

MSI Minimum Reads

This setting has no effect for AR models.

This feature specifies the minimum number of consecutive times an MSI label must be decoded before it is accepted as good read.

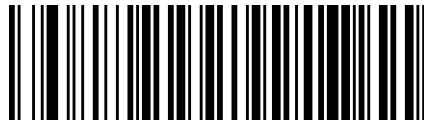

MSI Minimum Reads = 1



MSI Minimum Reads = 2

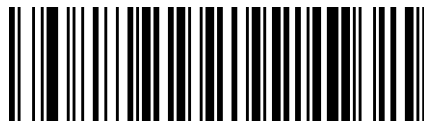

MSI Minimum Reads = 3



MSI Minimum Reads = 4





MSI Decoding Levels

This setting has no effect for AR models.

Decoding Levels are used to configure a bar code symbology decoder to be very aggressive to very conservative depending on a particular customer's needs.

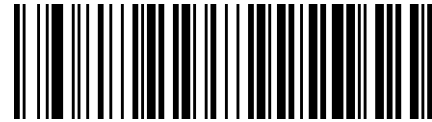

MSI Decoding Level = Disable

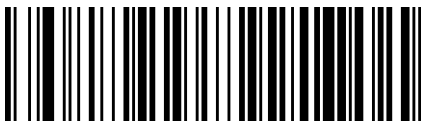

MSI Decoding Level = 1

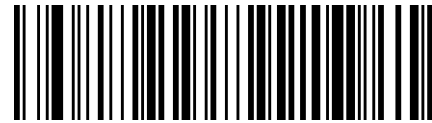

MSI Decoding Level = 2



MSI Decoding Level = 3



MSI Decoding Level = 4



MSI Decoding Level = 5



PLESSEY (ONLY STANDARD OPTIC MODELS)

This setting has no effect for AR models.
The following options apply to the Plessey symbology.

Plessey Enable/Disable

Enables/Disables ability of reader to decode Plessey labels.

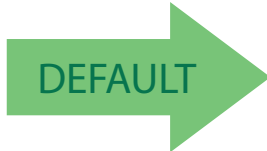

Plessey = Disable

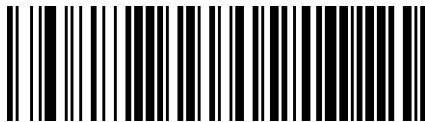

Plessey = Enable

Plessey Check Character Calculation

Enables/Disables calculation and verification of an optional Plessey check character.



Plessey Check Character Calculation = Disable



Plessey Check Character Calculation =
Enable Plessey std. check char. verification



Plessey Check Character Calculation =
Enable Anker check char. verification



Plessey Check Character Calculation =
Enable Plessey std. and Anker check char. verification



Plessey Check Character Transmission

Enables/disables transmission of an MSI check character.



Plessey Check Character Transmission = Disable



Plessey Check Character Transmission = Enable



Plessey Length Control

This feature specifies either variable length decoding or fixed length decoding for the Plessey symbology.

Variable Length: For variable length decoding, a minimum and maximum length may be set.

Fixed Length: For fixed length decoding, two different lengths may be set.

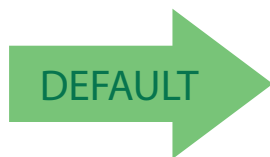

Plessey Length Control = Variable Length



Plessey Length Control = Fixed Length



Plessey Set Length 1

This feature specifies one of the bar code lengths for Plessey Length Control. Length 1 is the minimum label length if in Variable Length Mode, or the first fixed length if in Fixed Length Mode. Length includes the bar code's data characters only. The length can be set from 01 to 50 characters.

Table 28 provides some examples for setting Length 1. See page 297 for detailed instructions on setting this feature.

Table 28. Plessey Length 1 Setting Examples

STEP	ACTION	EXAMPLES			
1	Desired Setting	01 Characters	07 Characters	15 Characters	50 Characters
2	Scan ENTER/EXIT PROGRAMMING MODE				
3	Scan SELECT Plessey LENGTH 1 SETTING				
4	Scan Two Characters From Appendix D, Keypad	'0' and '1'	'0' and '7'	'1' and '5'	'5' AND '0'
5	Scan ENTER/EXIT PROGRAMMING MODE				



Select Plessey Length 1 Setting

Make a mistake? Scan the CANCEL bar code to abort and not save the entry string. You can then start again at the beginning.



CANCEL

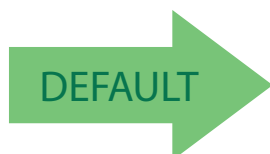

01 = Length 1 is 1 Character



Plessey Set Length 2

This feature specifies one of the bar code lengths for **Plessey Length Control**. Length 2 is the maximum label length if in **Variable Length Mode**, or the second fixed length if in **Fixed Length Mode**. Length includes the bar code's check, data, and full-ASCII shift characters. The length does not include start/stop characters.

The length can be set from 1 to 50 characters. A setting of 0 specifies to ignore this length (only one fixed length).

Table 29 provides examples for setting Length 2. See page 298 for detailed instructions on setting this feature.

Table 29. Plessey Length 2 Setting Examples

STEP	ACTION	EXAMPLES			
1	Desired Setting	00 (Ignore This Length)	07 Characters	15 Characters	50 Characters
2	Scan ENTER/EXIT PROGRAMMING MODE				
3	Scan SELECT PLESSEY LENGTH 2 SETTING				
4	Scan Two Characters From Appendix D, Keypad	'0' and '0'	'0' and '7'	'1' and '5'	'5' AND '0'
5	Scan ENTER/EXIT PROGRAMMING MODE				

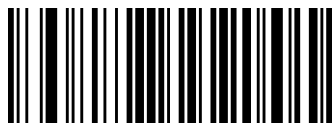

Select Plessey Length 2 Setting

Make a mistake? Scan the CANCEL bar code to abort and not save the entry string. You can then start again at the beginning.



CANCEL



50 = Length 2 is 50 Characters

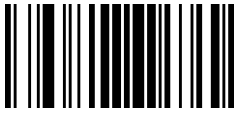

Plessey Minimum Reads

This feature specifies the minimum number of consecutive times a Plessey label must be decoded before it is accepted as good read.

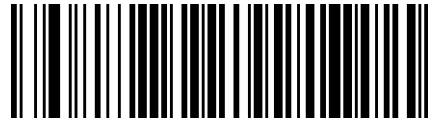

Plessey Minimum Reads = 1



Plessey Minimum Reads = 2



Plessey Minimum Reads = 3



Plessey Minimum Reads = 4





Plessey Decoding Levels

Specifies the decoding level for Plessey. Decoding Levels are used to configure a bar code symbology decoder to be very aggressive to very conservative depending on a particular customer's needs.



Plessey Decoding Level = Disable

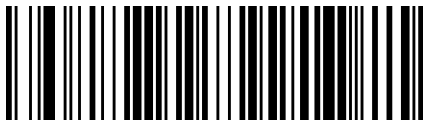

Plessey Decoding Level = 1 (conservative)



Plessey Decoding Level = 2



Plessey Decoding Level = 3



Plessey Decoding Level = 4



Plessey Decoding Level = 5 (aggressive)

NOTES

WIRELESS FEATURES

This section provides options and programming related to the reader's wireless communication features. Reference [Appendix C](#), for a listing of standard factory settings.

WIRELESS BEEPER FEATURES on page 217
GOOD TRANSMISSION BEEP on page 217
BEEP FREQUENCY on page 217
BEEP DURATION on page 218
BEEP VOLUME on page 219
DISCONNECT BEEP on page 219
LEASH ALARM on page 220
CONFIGURATION UPDATES on page 222
AUTOMATIC CONFIGURATION UPDATE on page 222
COPY CONFIGURATION TO SCANNER on page 223
COPY CONFIGURATION TO BASE STATION on page 223
BATCH FEATURES on page 224
BATCH MODE on page 224
SEND BATCH on page 225
ERASE BATCH MEMORY on page 225
RF BATCH MODE TRANSMIT DELAY on page 226
DIRECT RADIO AUTOLINK on page 227
RF ADDRESS STAMPING on page 227
SOURCE RADIO ADDRESS TRANSMISSION on page 227
SOURCE RADIO ADDRESS DELIMITER CHARACTER on page 228
REAL TIME CLOCK (RTC) CONFIGURATION on page 229
CURRENT DATE on page 229
CURRENT TIME on page 229
DATE TX FORMAT on page 230

TIME TX FORMAT on page 231
DATE-TIME SEPARATOR on page 231
DATE-TIME TRANSMISSION ORDER on page 232
POWER OFF on page 233
POWERDOWN TIMEOUT on page 233
PBT9300-ONLY FEATURES
BLUETOOTH SECURITY FEATURES on page 234
BLUETOOTH SECURITY MODE on page 235
BLUETOOTH PIN CODE on page 235
SELECT PIN CODE LENGTH on page 235
SET PIN CODE on page 236
OTHER BLUETOOTH FEATURES on page 237
RECONNECT ATTEMPT INTERVAL on page 237
BLUETOOTH HID VARIABLE PIN CODE on page 238
BLUETOOTH HID ALT MODE on page 239
BLUETOOTH MAX CLIENT on page 239
BLUETOOTH FRIENDLY NAME on page 241
BLUETOOTH RECONNECT ATTEMPT MODE on page 242
HID COUNTRY MODE on page 243
PM9300-ONLY FEATURES
STAR RADIO PROTOCOL TIMEOUT on page 247
STAR RADIO TRANSMIT MODE on page 248
RADIO SLEEP on page 249
CHANGING SYSTEM SPEED on page 250
COMPATIBILITY WITH PM8300 on page 252

DISPLAY AND KEYBOARD FEATURES
DISPLAY OPERATING MODE on page 252
DISPLAY OFF TIMEOUT on page 253
BACKLIGHT ENABLE on page 254
DISPLAY CONTRAST on page 255
FONT SIZE on page 255
ENABLE/DISABLE BUTTONS on page 256
ARROW KEYS MODE (4-KEY MODELS ONLY) on page 258
CONFIGURE CUSTOM LABEL STRING FOR ARROW UP KEY (4-KEY MODELS ONLY) on page 259
CONFIGURE CUSTOM LABEL STRING FOR ARROW DOWN KEY (4-KEY MODELS ONLY) on page 259
CONFIGURE ACTIONS FOR F1 on page 261
CONFIGURE ACTIONS FOR F2 on page 262
CONFIGURE ACTIONS FOR F3 (16-KEY MODELS ONLY) on page 263
CONFIGURE ACTIONS FOR F4 (16-KEY MODELS ONLY) on page 263
CONFIGURE ACTIONS FOR SHIFT (16-KEY MODELS ONLY) on page 264
DEFINE STRINGS on page 265
SET STRING ID on page 266
ADDITIONAL FEATURES FOR 16-KEY MODELS on page 268
SET STRING HEADER on page 266
SET STRING TERMINATOR on page 267
LAST CODE SHOWN TIMEOUT on page 268
DISPLAY TIME STAMPING MODE on page 269
MODE SELECTION on page 270
QUANTITY FIELD on page 271
QUANTITY/CODE SEND MODE on page 272
QUANTITY/CODE SEPARATOR on page 273
INTERKEY TIMEOUT on page 274
APPEND CODE on page 275

ECHO on page 276
KEYPRESS SOUND on page 277
SHIFT ENABLE/DISABLE on page 277
SHIFT KEY ASSOCIATION on page 278
LOWER CASE on page 279
SET F1 LABEL on page 280
SET F2 LABEL on page 280
SET F3 LABEL on page 281
SET F4 LABEL on page 281
BARCODE/KEY DIFFERENT DATA FORMAT on page 282
SET BARCODE HEADER on page 282
SET BARCODE TERMINATOR on page 283
SET KEY SEQUENCE ID on page 283
SET KEY SEQUENCE HEADER on page 283
SET KEY SEQUENCE TERMINATOR on page 284



WIRELESS BEEPER FEATURES

Several options are available to configure beeper behavior for RF operation.

Good Transmission Beep

Enables/disables the Good Transmission Beep indication. When enabled, a beep occurs when a Label is correctly transmitted to the base.

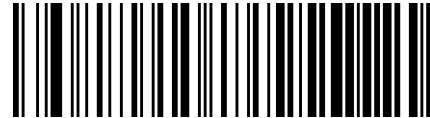

Good Transmission Beep = Disable

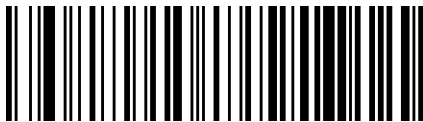

Good Transmission Beep = Enable



Beep Frequency

Adjusts radio-specific beep indications to sound at a low, medium or high frequency, selectable from the list below (controls the beeper's pitch/tone).

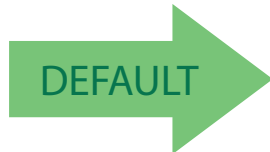

Beep Frequency = Low



Beep Frequency = Medium



Beep Frequency = High



Beep Duration

This feature controls the duration of radio-specific beep indications.



Beep Duration = 60 msec

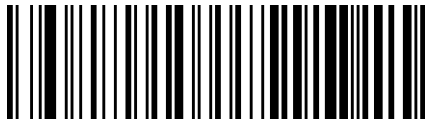

Beep Duration = 80 msec

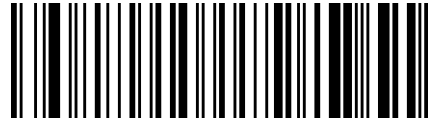

Beep Duration = 100 msec



Beep Duration = 120 msec

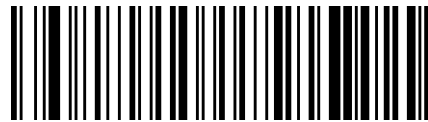

Beep Duration = 140 msec



Beep Duration = 160 msec



Beep Duration = 180 msec



Beep Duration = 200 msec



Beep Volume

Selects the beeper volume (loudness) of radio-specific beep indications. There are three selectable volume levels.



Beep Volume = Low

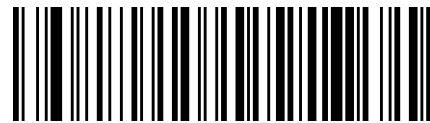

Beep Volume = Medium



Beep Volume = High



Disconnect Beep

Enables/disables the beep indication that a handheld has become connected or disconnected from a Base Station.



The defaults are different for the STAR and Bluetooth models.



Disconnect Beep = Disable



Disconnect Beep = Enable



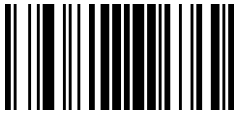

Leash Alarm

This setting specifies the number of seconds to sound the Leash Mode beeps (three per second) when the handheld goes out of range. This is especially useful in instances where the reader might inadvertently have been placed in a bag or cart.

For this mode to be effective, the reader must be linked to the Base Station. If the reader is asleep or disconnected from the Base Station, there is no way for it to know where it is relative to the Base Station because communication is not active between the devices.

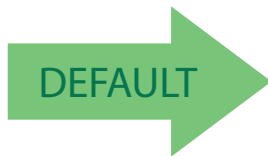

Leash Alarm = Disable

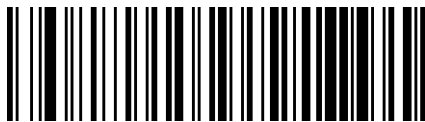

Leash Alarm = 1 Second

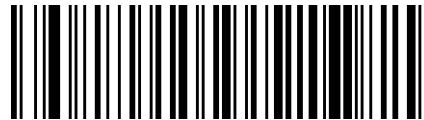

Leash Alarm = 2 Seconds



Leash Alarm = 3 Seconds



Leash Alarm = 4 Seconds



Leash Alarm = 5 Seconds



Leash Alarm (continued)

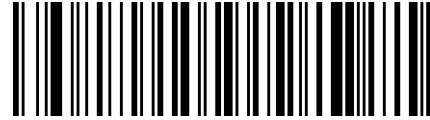

Leash Alarm = 10 Seconds



Leash Alarm = 25 Seconds

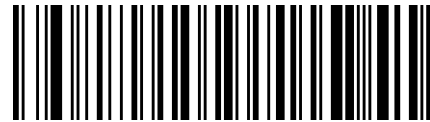

Leash Alarm = 30 Seconds



CONFIGURATION UPDATES

See [page 310](#) in “References” for detailed information and examples of these features.

Automatic Configuration Update

When this feature is enabled, a reader and its linked Base Station can automatically ensure they stay in sync with regard to application hardware and/or configuration. See [page 310](#) for more information on this feature.

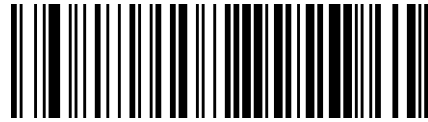

Automatic Configuration Update = Disable



Automatic Configuration Update = Enable





Copy Configuration to Scanner

Scan the following label to copy the current Base Station configuration to the scanner. Use this method when the Auto Configuration Update feature is disabled and you want a one-time configuration update to be performed on the scanner.



Do not scan an ENTER/EXIT PROGRAMMING MODE label with this bar code.



Copy Configuration to Scanner

Copy Configuration to Base Station

Scan the following label to copy the current scanner configuration to the Base Station. Use this method when the Auto Configuration Update feature is disabled and you want a one-time configuration update to be performed on the Base Station.



Copy Configuration to Base Station



Do not scan an ENTER/EXIT PROGRAMMING MODE label with this bar code.



BATCH FEATURES

Batch Mode

This option specifies whether to store labels in the handheld while disconnected from the base. Options are as follows:

- Disabled — The handheld will not store/batch labels.
- Automatic — The handheld will store labels when the handheld goes out of range and is disconnected from the remote device.
- Manual — The handheld will always store labels. The user must manually send the stored labels to the remote device using a special "batch send" label.

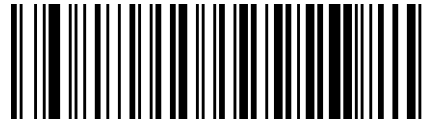
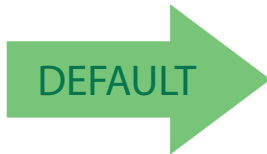

Batch Mode = Disable



Batch Mode = Automatic



Batch Mode = Manual



Send Batch

When the scanner is configured in Manual Batch Mode, use the following bar code to initiate sending of labels stored in batch memory.



Do not scan an ENTER/EXIT PROGRAMMING MODE label in conjunction with this bar code.



Send Batch

Erase Batch Memory

When the scanner is configured in Manual Batch Mode, use the following bar code to erase any labels stored in batch memory.



Do not scan an ENTER/EXIT PROGRAMMING MODE label in conjunction with this bar code.



Erase Batch Memory



RF Batch Mode Transmit Delay

Specifies the delay in 10 msec increments between transmitting labels stored in batch memory.

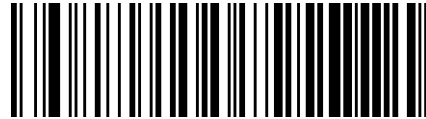
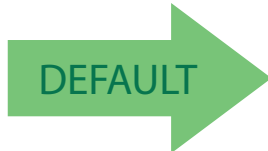

RF Batch Mode Transmit Delay = No Delay

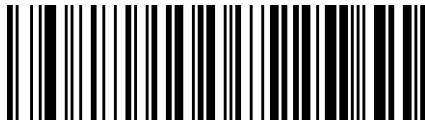

RF Batch Mode Transmit Delay = 50 mS

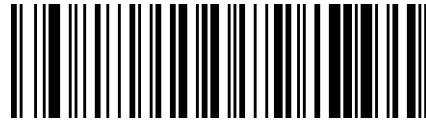

RF Batch Mode Transmit Delay = 100 mS



RF Batch Mode Transmit Delay = 0.5 seconds



RF Batch Mode Transmit Delay = 1 second



RF Batch Mode Transmit Delay = 2.5 seconds



DIRECT RADIO AUTOLINK

This feature enables/disables the ability to link a wireless handheld to a base station without scanning the Unlink label first.

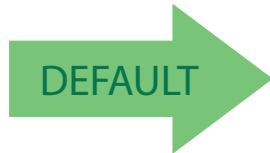

Direct Radio Link = Unlink Label Required

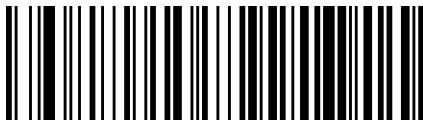

Direct Radio Link = Automatic Unlinking

RF ADDRESS STAMPING

These features allow configuration of source radio data inclusion.

Source Radio Address Transmission

Enables/disables the ability of source radio address information to be transmitted to the host and, if so, at what position with respect to the label data. See [page 310](#) in “References” for detailed information and examples for setting this feature.



When included as a prefix, the source-radio ID is displayed after all label formatting has been applied. The 6 byte hex address is sent as 12 ascii characters, i.e., an address of 00 06 66 00 1A ED will be sent as (shown in hex): 30 30 30 36 36 36 30 30 30 31 41 45 44

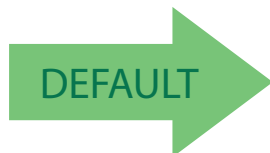

Source Radio Address Transmission = Do Not Include



Source Radio Address Transmission = Prefix



Source Radio Address Delimiter Character

This option specifies the delimiter character to be placed between the label data and radio address when address stamping is enabled.



This feature only applies if Source Radio Address Transmission on page 227 is enabled.



Set Source Radio Address Delimiter Character

To configure this feature, scan the ENTER/EXIT PROGRAMMING MODE bar code above, then the bar code at left followed by the digits from the Alphanumeric characters in [Appendix D, Keypad](#) representing your desired character(s). End by scanning the ENTER/EXIT bar code twice.

Make a mistake? Scan the CANCEL bar code to abort and not save the entry string. You can then start again at the beginning.

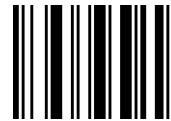

CANCEL

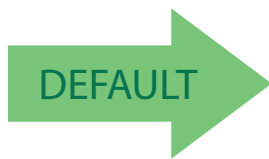

00 = No Delimiter Character



REAL TIME CLOCK (RTC) CONFIGURATION

Current Date

Sets the date of the internal Real Time Clock (RTC)

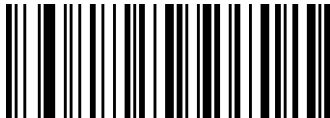

Set Current Date = YYMMDD

To configure this feature, scan the ENTER/EXIT PROGRAMMING MODE bar code above, then the bar code at left followed by the digits from the Alphanumeric characters in [Appendix D, Keypad](#) representing your desired character(s). End by scanning the ENTER/EXIT bar code twice.

Make a mistake? Scan the CANCEL bar code to abort and not save the entry string. You can then start again at the beginning.



CANCEL

Current Time

Sets the time of the internal Real Time Clock (RTC). HH = 24 hours format

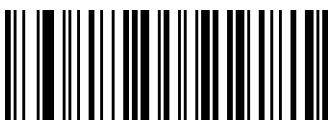

Set Current Time = HHMMSS

To configure this feature, scan the ENTER/EXIT PROGRAMMING MODE bar code above, then the bar code at left followed by the digits from the Alphanumeric characters in [Appendix D, Keypad](#) representing your desired character(s). End by scanning the ENTER/EXIT bar code twice.

Make a mistake? Scan the CANCEL bar code to abort and not save the entry string. You can then start again at the beginning.



CANCEL



Date Tx Format

Sets the format of the date.

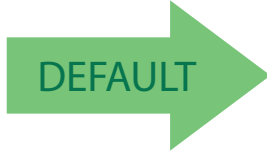

YYYY-MM-DD (ISO 8601)



YYYYMMDD (No ISO)



MMDDYYYY



DDMMYYYY



Time Tx Format

Sets the format of the time.

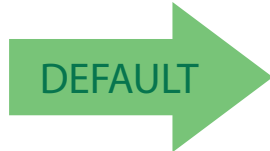

hh:mm:ss (ISO 8601)



hhmmss (No ISO)

Date-Time Separator

Sets the character used to separate Date and Time from the next field in message.

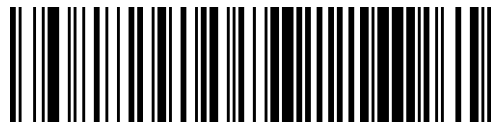
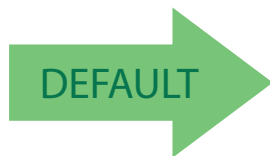

Disable Date-Time Separator



Set Character Separator

To configure this feature, scan the ENTER/EXIT PROGRAMMING MODE bar code above, then the bar code at left followed by 2 digits from the Alphanumeric characters in [Appendix D, Keypad](#) representing your desired character(s). End by scanning the ENTER/EXIT bar code twice.

Make a mistake? Scan the CANCEL bar code to abort and not save the entry string. You can then start again at the beginning.



CANCEL

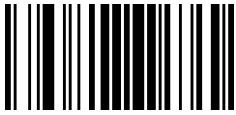

Date-Time Transmission Order

Allows the selection of the order of date and time transmission.

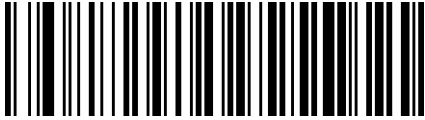

Disable

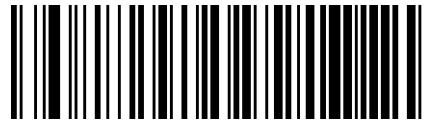

ISO 8601: Date'TTime



DateTime

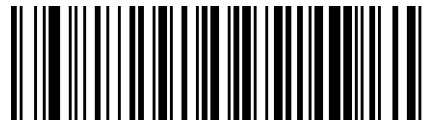

TimeDate



Date



Time



Power Off

See Power Off on page 20 for information about this feature.

Powerdown Timeout

The Powerdown Timeout feature sets the time for automatically switching the unit off when the imager has been idle.

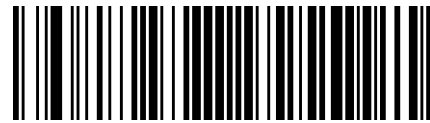

Powerdown Timeout = Disable



Powerdown Timeout = 10 minutes



Powerdown Timeout = 20 minutes



Powerdown Timeout = 30 minutes



Powerdown Timeout = 60 Minutes (1 Hour)



Powerdown Timeout = 120 Minutes (2 Hours)

PBT9300-ONLY FEATURES

The features in this section are valid only for PBT9300 Bluetooth models. Also reference the Setup section for instructions, see the paragraph [Linking the Reader on page 19](#).

BLUETOOTH SECURITY FEATURES

On the Bluetooth system, it is possible to set a (configurable) PIN code to authenticate/connect Bluetooth devices, and encrypt the data.

The Bluetooth PIN code can be enabled and configured by reading the bar codes in the following sections.



If you are using a Bluetooth scanner directly connected to a host through a Bluetooth dongle, verify that the scanner and the Bluetooth driver used by the dongle share the same PIN code and the same security level. Otherwise the connection cannot be established.

Follow these steps to set the PIN code for a scanner:

1. **Enable Bluetooth Security Mode** by scanning the “Enable” bar code below.
2. **Select a PIN code length of either 4 or 16 characters** by scanning the appropriate bar code in [Select PIN Code Length on page 235](#).
3. Scan the relevant bar code from [Set PIN Code on page 236](#), then scan the desired alphanumeric characters from the keypad in [Appendix D, Keypad](#) to set the PIN code.

See [page 312](#) in “References” for more detailed information and examples for this feature.



Bluetooth Security Mode

This feature enables/disables authentication and encryption of the Bluetooth link. Use the feature Bluetooth PIN Code, described below, to specify the length and digits in the PIN code used to authenticate the Bluetooth Link.



Changing the security mode setting will unlink the devices. If the Automatic Configuration Update is set to the default "Enabled" setting, the devices must only be relinked. If the Automatic Configuration Update is set to "Disabled," the Security Mode setting must also be updated in the Base Station using Aladdin. After the Base Station has been updated, the devices must be relinked.

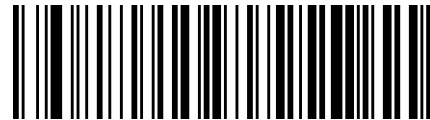
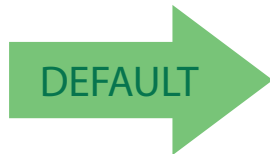

Bluetooth Security Mode = Disable



Bluetooth Security Mode = Enable

Bluetooth PIN Code

After enabling Security Mode (see Bluetooth Security Mode described above), specify whether you want to set a 4-digit or a 16-digit PIN Code. See page 312 for detailed information and examples for setting this feature.

Select PIN Code Length



Select 4-character Bluetooth PIN Code



Select 16-character Bluetooth PIN Code



Set PIN Code

Determine the desired characters for the PIN code, then convert to hexadecimal using the [ASCII Chart](#) on the inside back cover of this manual. See [page 312](#) for detailed information and examples for setting this feature.

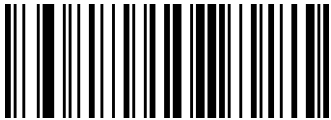

Set 4-character Bluetooth PIN Code

To configure this feature, scan the ENTER/EXIT PROGRAMMING MODE bar code above, then the bar code at left followed by the hexadecimal digits from the Alphanumeric characters in [Appendix D, Keypad](#) representing your desired character(s). End by scanning the ENTER/EXIT bar code twice.

To configure this feature, scan the ENTER/EXIT PROGRAMMING MODE bar code above, then the bar code at left followed by the hexadecimal digits from the Alphanumeric characters in [Appendix D, Keypad](#) representing your desired character(s). End by scanning the ENTER/EXIT bar code twice.



Set 16-character Bluetooth PIN Code



CANCEL

Make a mistake? Scan the CANCEL bar code to abort and not save the entry string. You can then start again at the beginning.

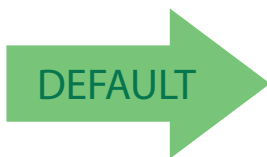

Default 4-char PIN Code is 1234
Default 16-char PIN Code is 1234567890ABCDEF



OTHER BLUETOOTH FEATURES

Reconnect Attempt Interval

This feature specifies the interval time between reconnection attempts.



Reconnect Attempt Interval = 1 minute

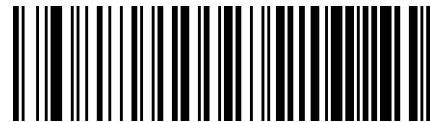

Reconnect Attempt Interval = 5 minutes



Reconnect Attempt Interval = 30 minutes

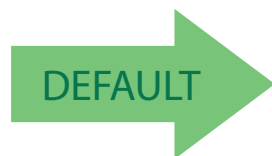

Reconnect Attempt Interval = Indefinitely



Bluetooth HID Variable PIN Code

Specifies the selection available for Static or Variable Pin Code, when Bluetooth HID profile is configured.

Some Bluetooth drivers on the Host (such as WIDCOMM and BlueSoleil 8) require a Variable PIN Code. When attempting connection, the application presents a window that includes a PIN Code which is to be input using the PowerScan BT9300. Scan the bar code "Variable PIN Code" below, then use the host computer's Bluetooth manager to "Discover new devices" and select "Datalogic Scanner." Use a text editor to see incoming data on the port designated by the computer's Bluetooth manager.



If you receive an error message, it may be necessary to disable security on the device.

When you hear the beep and see the Green LED blinking indicating the reader is waiting for an alphanumeric entry, enter the required variable PIN Code by scanning the corresponding bar codes in [Appendix D, Keypad](#) for alphanumeric entry. Finish by scanning the Exit HID Variable PIN Code label.



Set Static Pin Code



Set Variable Pin code



CANCEL

Make a mistake? Scan the CANCEL bar code to abort and not save the entry string. You can then start again at the beginning.

Exit HID Variable PIN Code



Bluetooth HID Alt Mode

Enable/Disable the ability to correctly transmit a label to the host regardless of the Bluetooth HID Country Mode selected, when Bluetooth HID Profile is configured.

Read the configuration command label below for the HID Alt Mode feature.

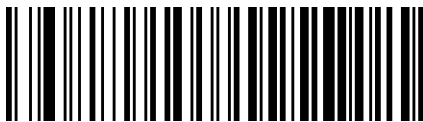

HID Alt Mode = OFF



HID Alt Mode = ON

Bluetooth Max Client

Set the number of Readers that can connect to the Base in a Piconet network.



Bluetooth Max Client = 1



Bluetooth Max Client = 2



Bluetooth Max Client = 3



Bluetooth Max Client (continued)

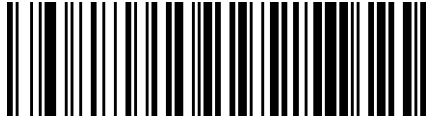

Bluetooth Max Client = 4

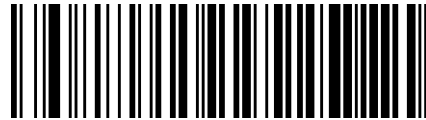

Bluetooth Max Client = 5

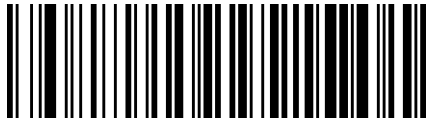

Bluetooth Max Client = 6

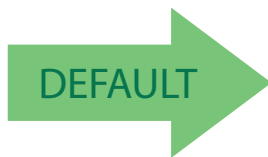

Bluetooth Max Client = 7



Bluetooth Friendly Name

You can set a meaningful name for PowerScan BT9300 that will appear in the application during device discovery.

To set a new Bluetooth Friendly Name, scan the barcode below and follow the instructions.

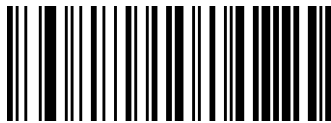

Set Bluetooth Friendly Name

To configure this feature, scan the ENTER/EXIT PROGRAMMING MODE bar code above, then the bar code at left followed by a maximum 64 digits from the Alphanumeric characters in [Appendix D, Keypad](#). The digits must be the hexadecimal ASCII representation of the desired characters. If less than the expected string of 32 characters are selected, scan the ENTER/EXIT bar code to terminate the string.

Make a mistake? Scan the CANCEL bar code to abort and not save the entry string. You can then start again at the beginning.



CANCEL



POWERSCAN BT9300
[SERIAL_NUMBER_SCANNER]



Enter/Exit Programming Mode

Bluetooth Reconnect Attempt Mode

Enable/Disable reconnection by trigger pull.

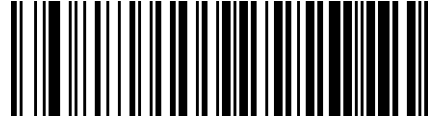

Bluetooth Reconnect Attempt Mode = Disable

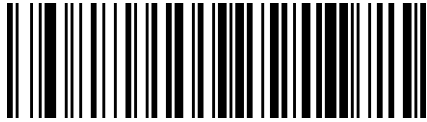

Bluetooth Reconnect Attempt Mode = Enable





HID Country Mode

When the Reader is connected with a Bluetooth Adapter in HID mode, you may want to set the country for which your PC is localized. In order to do that, read one of the configuration command labels below.



Country Mode = U.S.

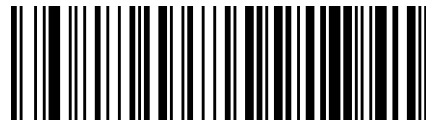

Country Mode = Belgium

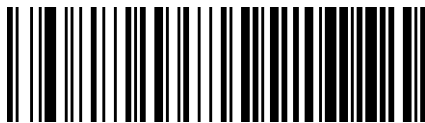

Country Mode = Britain



Country Mode = Denmark



Country Mode = France



HID Country Mode (continued)



Country Mode = Germany



Country Mode = Italy



Country Mode = Norway



Country Mode = Portugal

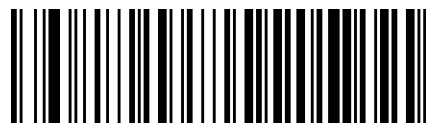

Country Mode = Spain



Country Mode = Sweden

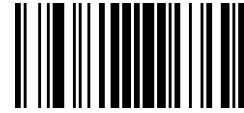

HID Country Mode (continued)



Country Mode = Switzerland



Country Mode = Japanese 106-key



Country Mode = Hungary



Country Mode = Czech Republic



Country Mode = Slovakia



Country Mode = Romania

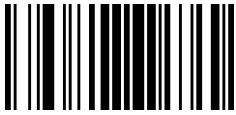

HID Country Mode (continued)



Country Mode = Croatia

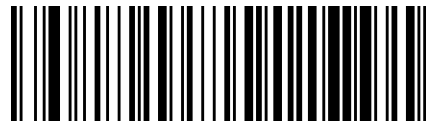

Country Mode = Poland



Country Mode = French Canadian

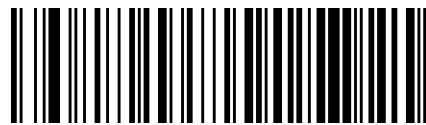

Country Mode = Lithuanian



PM9300-ONLY FEATURES

The features in this section are valid only for the PowerScan PM9300 Star model:

- STAR Radio Protocol Timeout
- STAR Radio Transmit Mode

STAR Radio Protocol Timeout

This parameter sets the valid wait time before transmission between the handheld reader and Base Station is considered failed.

When setting this parameter, take into consideration the radio traffic (number of readers in the same area). The selectable range for this feature is from 02 to 25 seconds. See [page 311](#) in “References” for detailed information and examples for setting this feature.

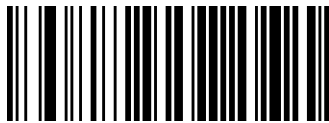

Set Radio Protocol Timeout

To configure this feature, scan the ENTER/EXIT PROGRAMMING MODE bar code above, then the bar code at left followed by two digits from the Alpha-numeric characters in [Appendix D, Keypad](#) representing your desired character(s). End by scanning the ENTER/EXIT bar code twice.

Make a mistake? Scan the CANCEL barcode to abort and not save the entry string. You can then start again at the beginning.



CANCEL

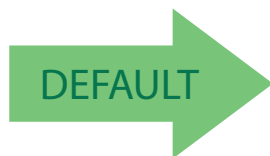

02 = 2 Seconds Radio Protocol Timeout



STAR Radio Transmit Mode

Specifies the transmission protocol for Star communications.

Options are:

- ACK from cradle to scanner — signals a good transmission as soon as the Base Station receives a label
- ACK when sent to host — scanner signals a good transmission as soon as the Base Station has sent the label to the host
- ACK from host — scanner signals a good transmission as soon as the Base Station has sent the label to the host and host has replied with an acknowledge message.

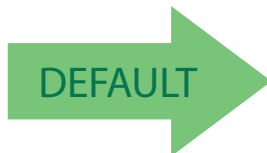

ACK from cradle

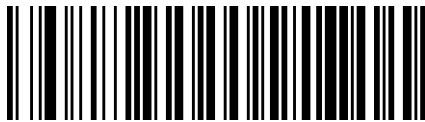

ACK when sent to host



ACK from host



ACK from host works only for RS-232 or USB-COM interfaces with ACK/NACK disabled. If ACK from host is configured with any other interface conditions, it works like ACK when sent to host. See [Message Formatting on page 313](#) for details. For this feature to be operational, the scanner must be set to Ignore Host Commands (see [page 23](#)).



Radio Sleep

This feature disables the radio when the scanner is in standby mode in order to save the battery power. When Radio sleep is enabled, the scanner cannot receive asynchronous messages nor paging button requests from the base. The scanner is still able to receive ACK From Host message. See Transmit mode.

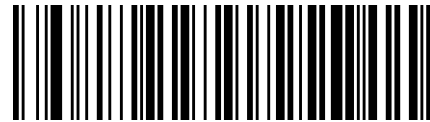

Sleep Disable

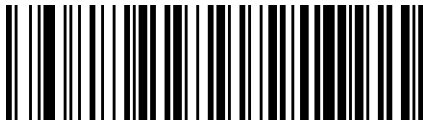

Sleep Enable





Changing System Speed

1. Link the PM9300 with a BC9xxx Base.
2. With the PM9300, read a New System Speed programming label.
3. Place the PM9300 into the BC9xxx.



Normal Mode: Low Speed (1)

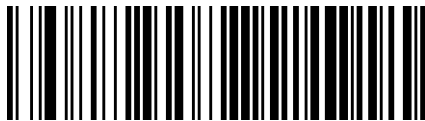

Normal Mode: High Speed (3)



The Reader and Base will now be linked at the new programmed speed.

This feature can also be programmed using Datalogic Aladdin.

1. On the BC9xxx Base, change the System Speed.
2. Place an unlinked PM9300 onto the BC9xxx base.

The Reader and base will link at the new programmed speed.



Restore Default command does not modify this parameter.



Frequency Agility

In exceptionally noisy environments or in case of a high concentration of radio devices, Star system performance may be improved by configuring Frequency Agility. Frequency Agility parameters change the way the radio frequencies are used in a Star communication system.

As when changing the System Speed, use the following procedure:

1. Link the PM9300 with a BC9xxx Base.
2. With the PM9300, read one of the “Frequency Agility” programming labels below.
3. Place the PM9300 into the BC9xxx.

Reader and Base will then be linked and the new frequencies handling will be operational.



Use default fixed channel



Enable frequency hopping
The channel is changed automatically



CAUTION

Restore Default command does not modify this parameter.



it is possible to select a fixed channel with a frequency different from the default; please contact Datalogic Technical Support for information about this feature.

For the 910 models, the radio range can change depending on the Frequency Agility parameter value; in particular, at low speed, the radio range is shorter when a fixed channel is programmed. See the Radio Range values in [Radio Features on page 320](#) of Technical Specifications.



COMPATIBILITY WITH PM8300

Compatibility Mode

Powerscan PM9300 offers a limited set of features compatible with the previous PM8300 family. To access those features, see the dedicated Compatible Mode Manual.

DISPLAY AND KEYBOARD FEATURES

Two keyboard models are available, the 4-key model and the 16-key model. The following section contains configuration parameters that are common and applicable to both keypad models, unless specifically labeled as "4-key models only" or "16-key models only".

For more items for the 16-key model, see [Additional Features for 16-key models on page 268](#).

Display Operating Mode

Select the operating mode of the display. Options are:

- **Local Echo:** Display cleared after decode, echo of the code on display.
- **Normal Mode:** Display not cleared, no echo of the code on Display.
- **Clear display after decode:** Display is cleared after decode, no echo.

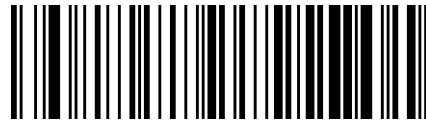

Local echo mode



Normal Mode = Display not cleared

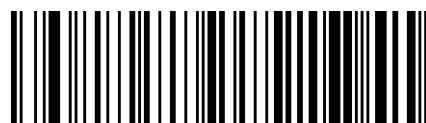

Clear display after decode



Display Off Timeout

Sets the timeout for display, backlight and keyboard.

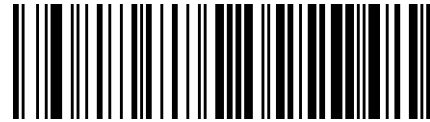

Display Off Timeout = Disable

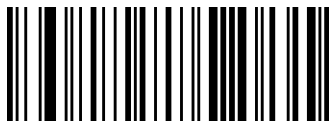

Set Display Off Timeout

To configure this feature, scan the ENTER/EXIT PROGRAMMING MODE bar code above, then the bar code at left followed by two digits from the Alphanumeric characters in [Appendix D, Keypad](#) representing your desired character(s). End by scanning the ENTER/EXIT bar code twice.

Make a mistake? Scan the CANCEL bar code to abort and not save the entry string. You can then start again at the beginning.



CANCEL

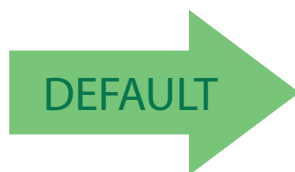

08 = 8 second delay



Backlight Enable

Enables/Disables the display backlight.

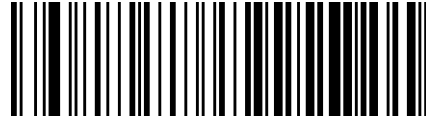
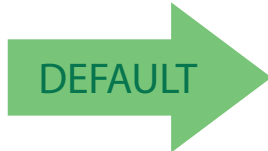

Backlight Disable (display and keyboard)

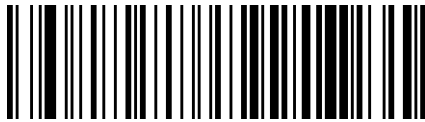

Backlight for Display enable
(4-keys models only)

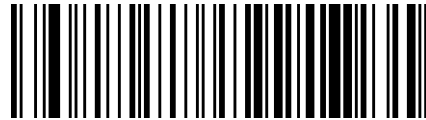

Backlight for Keyboard disable and display enable
(16-keys models only)



Backlight for Keyboard enable and display disable
(16-keys models only)

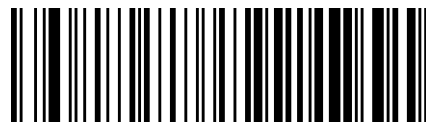

Backlight for Keyboard and display enable
(16-keys models only)



Display Contrast

Adjust the contrast of the display.

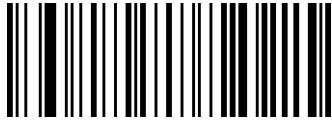

Set Display Contrast

To configure this feature, scan the ENTER/EXIT PROGRAMMING MODE bar code above, then the bar code at left followed by two digits (00-32 by 01) from the Alphanumeric characters in [Appendix D, Keypad](#) representing your desired character(s). End by scanning the ENTER/EXIT bar code twice.

Make a mistake? Scan the CANCEL bar code to abort and not save the entry string. You can then start again at the beginning.

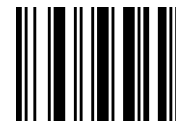

CANCEL

Font Size

Select the font size¹.

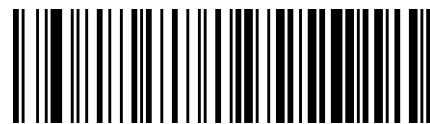
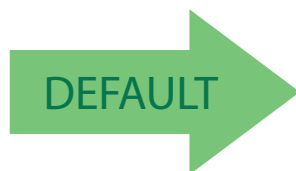

Font Size = Small



Font Size = Medium



Font Size = Large

1. 4-keys models only.



Enable/Disable Buttons

This feature offers the ability to enable or disable the keypad.

Figure 6. PowerScan 9300 Keypad Models

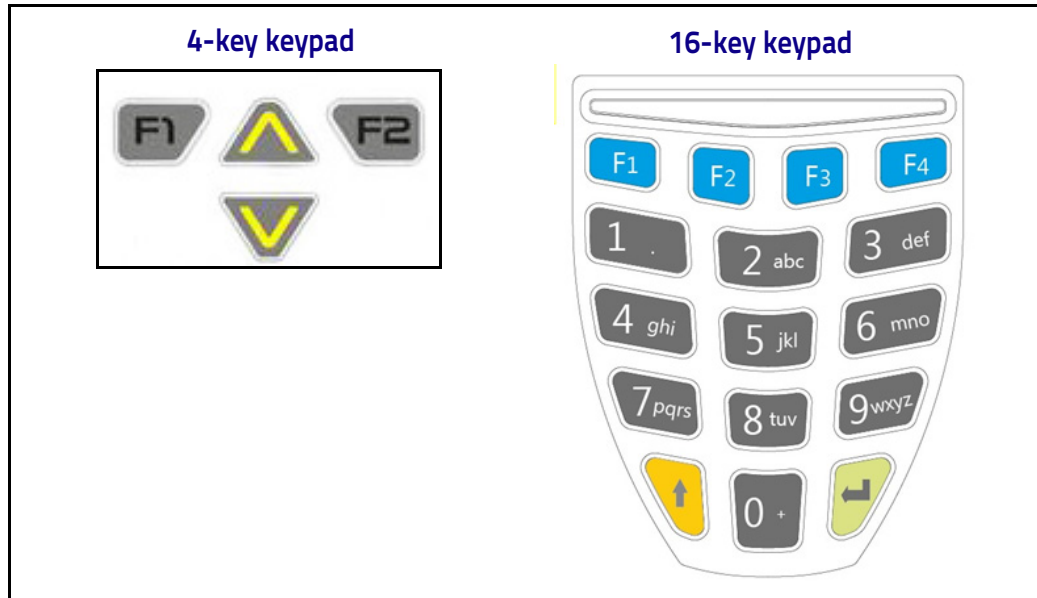

Key Programming

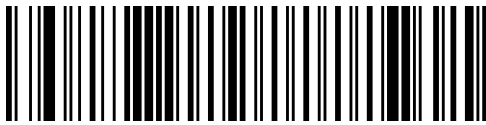

All keys enabled



All keys disabled



Enable a combination of keys (4-key models only)

To configure this feature, scan the ENTER/EXIT PROGRAMMING MODE bar code above, then the bar code at left followed by 4 digits from the Alphanumeric characters in [Appendix D, Keypad](#).

Make a mistake? Scan the CANCEL bar code to abort and not save the entry string. You can then start again at the beginning.



CANCEL

4-key models only: the first digit is used to enable or disable the four keys, the other three digit must be zero. To enable a combination of keys, sum each key's related weight, the result is the value to read using the Alphanumeric characters in Appendix D, keypad.

FIRST DIGIT FOR 4K MODEL	
KEY	WEIGHT
Arrow Up	8
F2	4
F1	2
Arrow Down	1

16-key models only: all the four digit are used to enable or disable keys. To enable a combination of keys, sum each key's related weight, the result is the value to read using the Alphanumeric characters in Appendix D, keypad.

FIRST DIGIT FOR 16K MODEL	
KEY	WEIGHT
Shift	8
F4	4
4	2
8	1

SECOND DIGIT FOR 16K MODEL	
KEY	WEIGHT
F1	8
1	4
5	2
9	1

THIRD DIGIT FOR 16K MODEL	
KEY	WEIGHT
F2	8
2	4
6	2
0	1

FOURTH DIGIT FOR 16K MODEL	
KEY	WEIGHT
F3	8
3	4
7	2
RETURN	1



Arrow Keys Mode (4-key models only)

Configure the Arrow Keys functionality type. Two options are available:

Function Keys Action Select mode. When in this mode, arrow keys are used to select one of the 3 possible actions associated to the Function Keys. To associate actions to the Function keys, see [Configure Actions for Function keys on page 260](#).

String Association Mode. When in this mode, each one of the arrow keys can be programmed to display and transmit a pre-defined string (see [Arrow Keys Mode \(4-key models only\) on page 258](#) and [Configure Custom Label String for Arrow Down Key \(4-key models only\) on page 259](#). Default string for Up and Down is "=").



Function Keys Action Select Mode



String Association Mode



Configure Custom Label String for Arrow Up Key (4-key models only)

Associate a pre-defined string to the Arrow Up key



Configure Custom Label String for Arrow Up Key

To configure this feature, scan the ENTER/EXIT PROGRAMMING MODE bar code above, then the bar code at left. Define the label string by further scanning 4 digits from the Alphanumeric characters in [Appendix D, Keypad](#).

The digits must be the hexadecimal ASCII representation of the desired characters; if less than the expected string of 16 characters are selected, scan the ENTER/EXIT bar code to terminate the string.

End by scanning the ENTER/EXIT bar code twice.

Make a mistake? Scan the CANCEL bar code to abort and not save the entry string. You can then start again at the beginning.

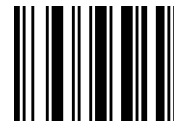

CANCEL

Configure Custom Label String for Arrow Down Key (4-key models only)

Associate a pre-defined string to the Arrow Up key



Configure Custom Label String for Arrow Down Key

To configure this feature, scan the ENTER/EXIT PROGRAMMING MODE bar code above, then the bar code at left. Define the label string by further scanning 4 digits from the Alphanumeric characters in [Appendix D, Keypad](#).

The digits must be the hexadecimal ASCII representation of the desired characters; if less than the expected string of 16 characters are selected, scan the ENTER/EXIT bar code to terminate the string.

End by scanning the ENTER/EXIT bar code twice.

Make a mistake? Scan the CANCEL bar code to abort and not save the entry string. You can then start again at the beginning.



CANCEL

CONFIGURE ACTIONS FOR FUNCTION KEYS

Each of the function keys can be programmed to perform a user-assigned function. This is done by associating a function key with either a predefined command or your own custom string. See the [Define Strings on page 265](#) command to define customized strings.

Each function key has an associated label which shows in the display when active. The default labels are shown in the table below. To program the function key labels, see [Set String ID on page 266](#).

The following table shows the list of predefined commands and available strings.

Table 30. Keyboard Programming

CMD_ID	Name	Function	Default Label	16K	4K
0	Not configured	Not configured action. If a key must be kept enabled but isn't required in normal mode, this function can be selected to keep it ineffective. Whenever an unconfigured function key is pressed, an error message appears on the display and an error beep is emitted.	<None >	✓	✓
1	Enter CMD	Same as ENTER_KEY.	Ent	✓	✗
2	String 1	Display and transmit string 1.	S1T	✓	✓
3	String 2	Display and transmit string 2.	S2T	✓	✓
4	String 3	Display and transmit string 3.	S3T	✓	✓
5	String 4	Display and transmit string 4.	S4T	✓	✓
6	String 5	Display and transmit string 5.	S5T	✓	✓
7	Backlight CMD	Toggle backlight on/off.	BlT	✓	✓
8	Clear CMD	Clears the screen	CLR	✓	✓
9	Backspace CMD	Same as Backspace key.	←	✓	✗
A	Recall	If pressed once, it recalls the last code sent out. If pressed twice, resends the last code.	Rcl	✓	✓
B	Show Date/ Time	Display the internal date, time.	Tim	✓	✓
C	Scroll Up	Scroll up display content by row	Up	✓	✓
D	Scroll Down	Scroll down display content by row	Dwn	✓	✓
E	Dot char	Display dot [.] char	[.]	✓	✗
F	Dynamic Quantity	Dynamic Quantity Code function	Qty	✓	✗



ACTION CONFIGURATION FOR FUNCTION KEYS

Configure actions (up to three for 4K model when configured with "Function Keys Action Select Mode") for the function keys

Configure Actions for F1

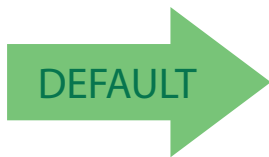

F1 No Actions Configured



Configure Actions for F1

To configure this feature, scan the ENTER/EXIT PROGRAMMING MODE bar code above, then the bar code for the Function Key you want to program. Next scan 4 digits from the Alphanumeric characters in [Appendix D, Keypad](#).

The first digit must be 0, the second is used by 4K and 16K model, the remaining third and fourth are used only by 4K model. Second, third and fourth digit must be configured according to the CMD_ID numbers in [Table 30 on page 260](#). Confirm the inserted value by scanning the ENTER/EXIT bar code.

Make a mistake? Scan the CANCEL bar code to abort and not save the entry string. You can then start again at the beginning.



CANCEL

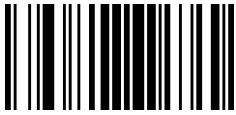

Configure Actions for F2

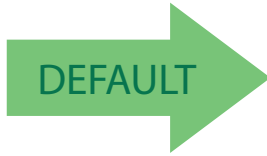

F2 No Actions Configured



Configure Actions for F2

To configure this feature, scan the ENTER/EXIT PROGRAMMING MODE bar code above, then the bar code for the Function Key you want to program. Next scan 4 digits from the Alphanumeric characters in [Appendix D, Keypad](#).

The first digit must be 0, the second is used by 4K and 16K model, the remaining third and fourth are used only by 4K model. Second, third and fourth digit must be configured according to the CMD_ID numbers in [Table 30 on page 260](#). Confirm the inserted value by scanning the ENTER/EXIT bar code.

Make a mistake? Scan the CANCEL bar code to abort and not save the entry string. You can then start again at the beginning.



CANCEL



FUNCTION KEYS CONFIGURATION (16-KEY MODELS ONLY)

Function Keys F3 through F5 are available on 16-key models only. For more 16-key programming, see [Additional Features for 16-key models on page 268](#).

Configure Actions for F3 (16-key models only)

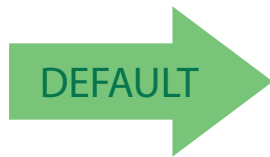

F3 No Actions Configured



Configure Actions for F3

To configure this feature, scan the ENTER/EXIT PROGRAMMING MODE bar code above, then the bar code for the Function Key you want to program. Next scan 4 digits from the Alphanumeric characters in [Appendix D, Keypad](#).

The first digit must be 0, the second digit must be configured according to the CMD_ID numbers in [Table 30 on page 260](#). The third and fourth must be zero. Confirm the inserted value by scanning the ENTER/EXIT bar code.

Configure Actions for F4 (16-key models only)

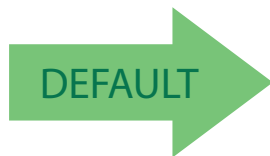

F4 No Actions Configured



Configure Actions for F4

To configure this feature, scan the ENTER/EXIT PROGRAMMING MODE bar code above, then the bar code for the Function Key you want to program. Next scan 4 digits from the Alphanumeric characters in [Appendix D, Keypad](#).

The first digit must be 0, the second digit must be configured according to the CMD_ID numbers in [Table 30 on page 260](#). The third and fourth must be zero. Confirm the inserted value by scanning the ENTER/EXIT bar code



Configure Actions for Shift (16-key models only)

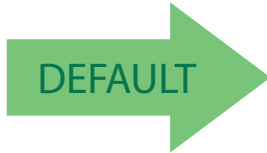

Shift No Actions Configured



Configure Actions for Shift

To configure this feature, scan the ENTER/EXIT PROGRAMMING MODE bar code above, disable the SHIFT by reading "Disable SHIFT function" on page 266, then read "Configure Actions for Shift" on the left. Next scan 4 digits from the Alphanumeric characters in [Appendix D, Keypad](#) The first digit must be 0, the second digit must be configured according to the CMD_ID numbers in [Table 30 on page 260](#). The third and fourth digit must be zero.



Define Strings

Configure string 1–5.

To configure this feature, scan the ENTER/EXIT PROGRAMMING MODE bar code at the top of the page, then the bar code for the String you want to set. Define the label string by scanning 32 digits from the Alphanumeric characters in [Appendix D, Keypad](#).

The digits must be the hexadecimal ASCII representation of the desired characters; if less than the expected string of 16 characters are selected, scan the ENTER/EXIT bar code to terminate the string.

End by scanning the ENTER/EXIT bar code twice.



Set String 1



Set String 2



Set String 3



Set String 4



Set String 5

Make a mistake? Scan the CANCEL bar code to abort and not save the entry string. You can then start again at the beginning.



CANCEL



Set String ID

Sets the identifier of the predefined strings.



Set String ID

To configure this feature, scan the ENTER/EXIT PROGRAMMING MODE bar code above, then the bar code at left followed by 6 digits from the Alphanumeric characters in [Appendix D, Keypad](#).

The ID characters must be represented by their hexadecimal ASCII code; if the first 2 digits are 0, this feature is disabled. End by scanning the ENTER/EXIT bar code twice.

Make a mistake? Scan the CANCEL bar code to abort and not save the entry string. You can then start again at the beginning.

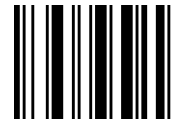

CANCEL

Set String Header

Sets the header of the predefined strings.

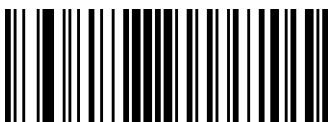

Set String Header

To configure this feature, scan the ENTER/EXIT PROGRAMMING MODE bar code above, then the bar code at left followed by 32 digits from the Alphanumeric characters in [Appendix D, Keypad](#).

The digits must be the hexadecimal ASCII representation of the desired characters. If less than the expected string of 16 characters are selected, scan the ENTER/EXIT bar code to terminate the string.

If the first 2 digits are 0, the feature is disabled. End by scanning the ENTER/EXIT bar code twice.

Make a mistake? Scan the CANCEL bar code to abort and not save the entry string. You can then start again at the beginning.



CANCEL



Set String Terminator

Sets the terminator of the predefined strings.



Set String Terminator

To configure this feature, scan the ENTER/EXIT PROGRAMMING MODE bar code above, then the bar code at left followed by 32 digits from the Alphanumeric characters in [Appendix D, Keypad](#).

The digits must be the hexadecimal ASCII representation of the desired characters. If less than the expected string of 16 characters are selected, scan the ENTER/EXIT bar code to terminate the string.

If the first 2 digits are 0, the feature is disabled. End by scanning the ENTER/EXIT bar code twice.

Make a mistake? Scan the CANCEL bar code to abort and not save the entry string. You can then start again at the beginning.

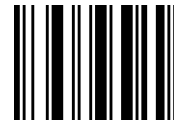

CANCEL

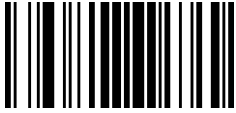

ADDITIONAL FEATURES FOR 16-KEY MODELS

See also [Function Keys Configuration \(16-key models only\)](#) on page 263.

Last Code Shown Timeout

After the CODE transmission, the last code read will be shown on the display for a configurable timeout (LAST CODE SHOWN TOUT).



The standard DISPLAY OFF TIMEOUT (see [page 253](#)) has a higher priority than the LAST CODE SHOWN TOUT, so the two parameters should be combined to get the desired result.



Last Code Shown Timeout

To configure this feature, scan the ENTER/EXIT PROGRAMMING MODE bar code above, then the bar code at left followed by 2 digits (00-63 by 01) from the Alphanumeric characters in [Appendix D, Keypad](#).

End by scanning the ENTER/EXIT bar code twice.

Make a mistake? Scan the CANCEL bar code to abort and not save the entry string. You can then start again at the beginning.



CANCEL



Display Time Stamping Mode

Time Stamping Mode can be applied when entering data from either a barcode, from the keyboard, or both.



Applied to both

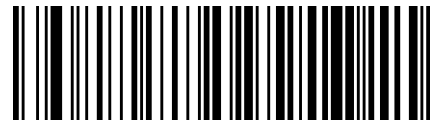

Applied only to barcode data

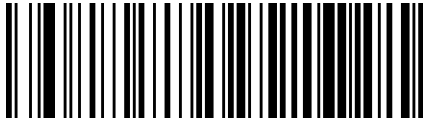

Applied only to keyboard data



Mode Selection

This feature allows the PowerScan 16K model to operate in one of two basic operative modes:

- Normal Mode — data entered, either on the keypad or read via barcode, is transmitted to the host once the enter key is pressed, following the configured formatting.
- Quantity/Code Mode — Can be further configured. See the next sections for Qty/Code operations. .

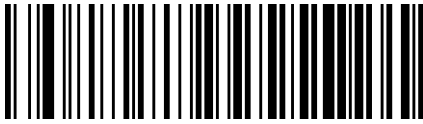

Set Normal Mode



Set Qty/Code Mode



Quantity Field

This feature defines the behavior of the scanner if no data is entered in the QTY field so that it is left empty. Options are:

- code is transmitted with default QTY ('1')
- code is transmitted alone (without any quantity information)
- code is discarded and an error beep is generated

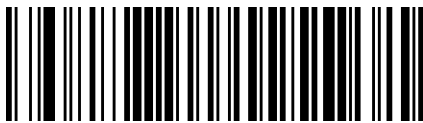

Transmit code with default qty (1)



Transmit Code only



Discard Code



Quantity/Code Send Mode

This feature defines the rules that will be used to send a QTY/CODE pair:

0. Code is transmitted with QTY field (and its predefined format) preceding CODE field (and its predefined format)
1. Code is transmitted with CODE field (and its predefined format) preceding QTY field (and its predefined format)
2. Code in CODE field is sent out for the number of times defined in the QTY field



Qty precedes Code



Code precedes Qty



Code transmitted Qty times



Quantity/Code Separator

This feature allows the insertion of a separator between Qty/Code pairs.

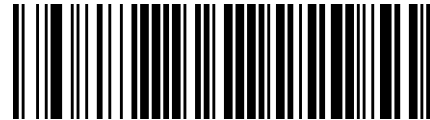
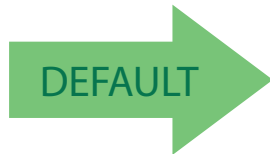

No separator

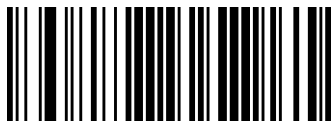

Set Qty/Code string separator

To configure this feature, scan the ENTER/EXIT PROGRAMMING MODE bar code above, then the barcode at left. Next scan 1 digit from [Appendix D, Keypad](#) (in the range 1-8) representing the number of characters to be used as separator.

Finally, define the separator string by reading the desired characters from the ASCII table at the back of this manual, expressed in hexadecimal form. End by scanning the ENTER/EXIT bar code twice.



Interkey Timeout

The 16-key keypad is organized like a cell phone, with multi-tap access to alpha characters on numeric keys. In alphabetic mode (entered by toggling the SHIFT key), the keys must be pressed once, twice, or more to obtain the desired letter.

This command allows you to specify the time which occurs between a key press, and the confirmation of the letter by the scanner (when in alpha mode). The timeout can be configured in increments of 0.5 second.

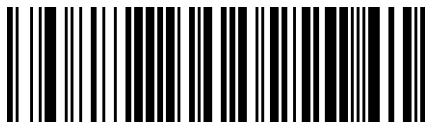

Interkey Timeout = 0.5 seconds

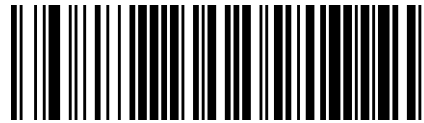
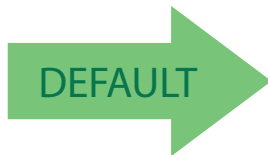

Interkey Timeout = 1.0 seconds



Interkey Timeout = 1.5 seconds

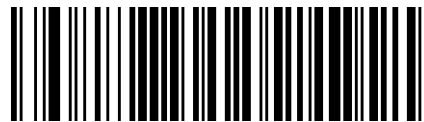

Interkey Timeout = 2.0 seconds



Append Code

This function defines how a scanned barcode interacts with a pre-edited CODE field, or with a string entered by a preprogrammed FUNC KEY.

Options are:

0. Barcode data overwrites what is written in the CODE field by keyboard and the code is transmitted;
1. Barcode data is appended to any text in the CODE field and the code is transmitted;
2. Barcode data is appended to any text in the CODE field but the code IS NOT transmitted. Data is transmitted when the enter key is pressed.



Append Code = Overwrite always



Append Code = Append and transmit



Append Code = Append and don't transmit

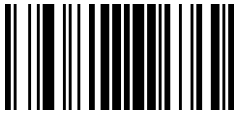

Echo

This function enables/disables the keypad echo. It works only when the scanner is in simple data input mode (no QTY/CODE).

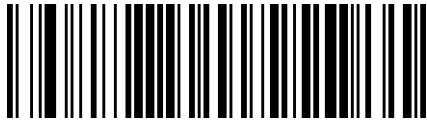

Echo = Full Keypad echo

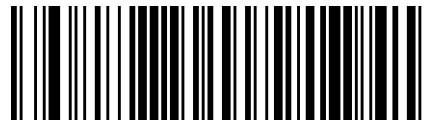

Echo = No echo on function key

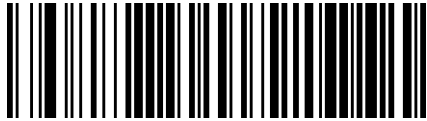

Echo = No echo on any key



Keypress Sound

Enables/disables the KEY press sound ('click').

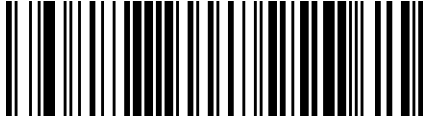

Keypress Sound = Disable

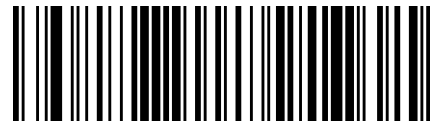
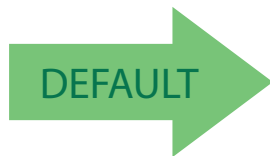

Keypress Sound = Enable

SHIFT Enable/Disable

This function enables/disables the SHIFT function.



Disable SHIFT function

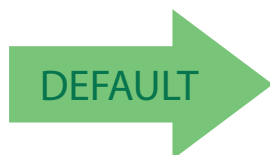

Enable SHIFT function

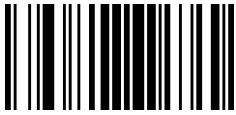

SHIFT Key Association

This function allows the association of the SHIFT function to one of the following keys: F1, F2, F3, F4, ↑ (up arrow key).

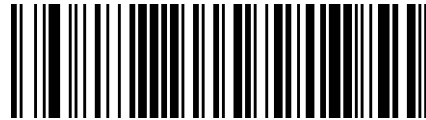

Associate SHIFT to F1



Associate SHIFT to F2



Associate SHIFT to F3



Associate SHIFT to F4

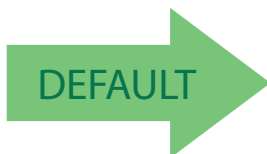

Associate SHIFT to ↑



Lower Case

This function enables/disables the capability to use the SHIFT key to switch to Lower Case (alphanumeric) mode. When enabled, the indication in the upper right corner of display is 'ab'.

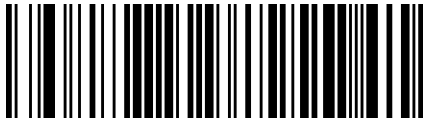

Disable Lower Case



Enable Lower Case



SET FUNCTION KEY LABELS

Set F1 Label

This item allows the user to change the default mnemonic label associated to each individual function key. This is done by programming a short acronym 4-character string to be shown in the bottom of the display. The purpose of the label is to serve as an indication of the programmed function of the Function Key below it.

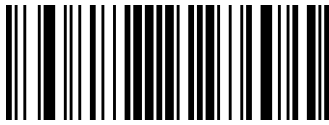

Set F1 label

To configure this feature, scan the ENTER/EXIT PROGRAMMING MODE bar code above, then the bar code at left followed by 8 digits from the [Appendix D, Keypad](#). The digits must be the hexadecimal ASCII representation of the desired characters.

End by scanning the ENTER/EXIT bar code twice.

Set F2 Label

This item allows the user to change the default mnemonic label associated to each individual function key. This is done by programming a short acronym 4-character string to be shown in the bottom of the display. The purpose of the label is to serve as an indication of the programmed function of the Function Key below it.



Set F2 label

To configure this feature, scan the ENTER/EXIT PROGRAMMING MODE bar code above, then the bar code at left followed by 8 digits from the [Appendix D, Keypad](#). The digits must be the hexadecimal ASCII representation of the desired characters.

End by scanning the ENTER/EXIT bar code twice.



Set F3 Label

This item allows the user to change the default mnemonic label associated to each individual function key. This is done by programming a short acronym 4-character string to be shown in the bottom of the display. The purpose of the label is to serve as an indication of the programmed function of the Function Key below it.



Set F3 label

To configure this feature, scan the ENTER/EXIT PROGRAMMING MODE bar code above, then the bar code at left followed by 8 digits from the [Appendix D, Keypad](#). The digits must be the hexadecimal ASCII representation of the desired characters.

End by scanning the ENTER/EXIT bar code twice.

Set F4 Label

This item allows the user to change the default mnemonic label associated to each individual function key. This is done by programming a short acronym 4-character string to be shown in the bottom of the display. The purpose of the label is to serve as an indication of the programmed function of the Function Key below it.



Set F4 label

To configure this feature, scan the ENTER/EXIT PROGRAMMING MODE bar code above, then the bar code at left followed by 8 digits from the [Appendix D, Keypad](#). The digits must be the hexadecimal ASCII representation of the desired characters.

End by scanning the ENTER/EXIT bar code twice.



Barcode/Key Different Data Format

If this parameter is enabled, barcode and keyboard entered data can be formatted separately. More specifically: if this parameter is disabled, barcode and keyboard data will share the same Header and Terminator defined using “Set Barcode Header” and “Set Barcode Terminator” below. If this parameter is enabled, keyboard entered data are treated differently, as their format must be programmed through the parameters [Set String Header](#), [Set String Terminator](#), [Set Key Sequence Header](#) and [Set Key Sequence Terminator](#).

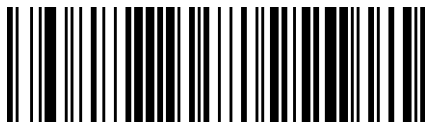

Disable

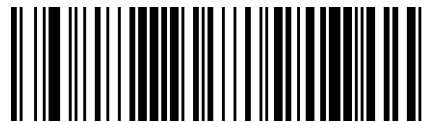

Enable

Set Barcode Header

Sets the header for barcode and keyboard composed strings.



Set barcode header

To configure this feature, scan the ENTER/EXIT PROGRAMMING MODE bar code above, then the bar code at left followed by 32 digits from the Alphanumeric characters in [Appendix D, Keypad](#). The digits must be the hexadecimal ASCII representation of the desired characters.

If less than the expected string of 16 characters are selected, scan the ENTER/EXIT bar code to terminate the string. If the first 2 digits are 0, the feature is disabled. End by scanning the ENTER/EXIT bar code twice.



Set Barcode Terminator

Sets the terminator for barcode and keyboard composed strings.



Set barcode terminator

To configure this feature, scan the ENTER/EXIT PROGRAMMING MODE bar code above, then the bar code at left followed by 32 digits from the Alphanumeric characters in [Appendix D, Keypad](#). The digits must be the hexadecimal ASCII representation of the desired characters.

If less than the expected string of 16 characters are selected, scan the ENTER/EXIT bar code to terminate the string. If the first 2 digits are 0, the feature is disabled. End by scanning the ENTER/EXIT bar code twice.

Set Key Sequence ID

Sets the identifier for keyboard composed strings.



Set keys sequence ID

To configure this feature, scan the ENTER/EXIT PROGRAMMING MODE bar code above, then the bar code at left followed by 6 digits from [Appendix D, Keypad](#).

The ID characters must be represented by their hexadecimal ASCII code; if the first 2 digits are 0, this feature is disabled. End by scanning the ENTER/EXIT bar code twice.

Set Key Sequence Header

Sets the header for keyboard composed strings.

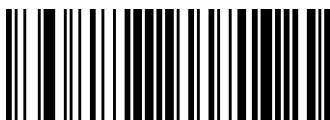

Set key sequence header

To configure this feature, scan the ENTER/EXIT PROGRAMMING MODE bar code above, then the bar code at left followed by 32 digits from the Alphanumeric characters in [Appendix D, Keypad](#). The digits must be the hexadecimal ASCII representation of the desired characters.

If less than the expected string of 16 characters are selected, scan the ENTER/EXIT bar code to terminate the string.

If the first 2 digits are 0, the feature is disabled. End by scanning the ENTER/EXIT bar code twice.



Set Key Sequence Terminator

Sets the terminator for keyboard composed strings.



Set key sequence terminator

To configure this feature, scan the ENTER/EXIT PROGRAMMING MODE bar code above, then the bar code at left followed by 32 digits from the Alphanumeric characters in [Appendix D, Keypad](#). The digits must be the hexadecimal ASCII representation of the desired characters.

If less than the expected string of 16 characters are selected, scan the ENTER/EXIT bar code to terminate the string.

If the first 2 digits are 0, the feature is disabled. End by scanning the ENTER/EXIT bar code twice.



Chapter 4 References

This section contains explanations and examples of selected bar code features. See [Configuration Using Bar Codes](#) on page 21 for the actual bar code labels used to configure the reader.

RS-232 ONLY on page 286
RS-232/USB COM PARAMETERS on page 287
KEYBOARD INTERFACE on page 294
WEDGE QUIET INTERVAL on page 294
INTERCHARACTER DELAY on page 295
INTERCODE DELAY on page 296
SYMBOLOGIES on page 297
Decoding Safety on page 297
SET LENGTH on page 297
DATA EDITING on page 299
GLOBAL PREFIX/SUFFIX on page 300
GLOBAL AIM ID on page 301
LABEL ID on page 302
CHARACTER CONVERSION on page 306
READING PARAMETERS on page 307
GOOD READ LED DURATION on page 307
SCANNING FEATURES on page 308
SCAN MODE on page 308
WIRELESS FEATURES on page 310
AUTOMATIC CONFIGURATION UPDATE on page 310
RF ADDRESS STAMPING on page 310
BLUETOOTH-ONLY FEATURES on page 312

RS-232 Parameters

RS-232 Only

Baud Rate

Baud rate is the number of bits of data transmitted per second. Set the reader's baud rate to match the baud rate setting of the host device. With an improper baud rate setting, data may not reach the host correctly.

Stop Bits

The stop bit(s) at the end of each transmitted character marks the end of transmission of one character and prepares the receiving device for the next character in the serial data stream. The number of stop bits selected (one or two) depends on the number the receiving terminal is programmed to accommodate. Set the number of stop bits to match host device requirements.

Parity

This feature specifies parity required for sending and receiving data. A parity check bit is the most significant bit of each ASCII coded character. Select the parity type according to host device requirements.

- Select None when no parity bit is required.
- Select Odd parity and the parity bit value is set to 0 or 1, based on data, to ensure that an odd number of 1 bits are contained in the coded character.
- Select Even parity and the parity bit value is set to 0 or 1, based on data, to ensure that an even number of 1 bits are contained in the coded character.

Handshaking Control

The data interface consists of an RS-232 port designed to operate either with or without the hardware handshaking lines, *Request to Send* (RTS), and *Clear to Send* (CTS). Handshaking Control includes the following options:

- RTS — RTS is asserted during transmissions. CTS is ignored.
- RTS/CTS — RTS is asserted during transmissions. CTS gates transmissions.
- RTS/XON/XOFF — RTS is asserted during transmissions. CTS is ignored. XON and XOFF gate transmissions.
- RTS On/CTS — RTS is always asserted. CTS gates transmissions.

RTS/CTS Scan Control — RTS is asserted during transmissions. CTS gates transmissions and controls enable and disable state of scanner.

RS-232/USB COM Parameters

Intercharacter Delay

This parameter specifies the intercharacter delay between the end of one character and the beginning of the next. The delay can be set within a range of zero (0) to 990 milliseconds in 10ms increments. A setting of zero specifies no delay.

To set the delay:

1. Determine the desired setting in milliseconds.
2. Divide the desired setting by 10 (setting is in 10ms increments). Pad the result with leading zeroes to yield two digits. For example: 0 = 00, 5 = 05, 20 = 20, etc.
3. Scan the ENTER/EXIT PROGRAMMING MODE bar code to enter Programming Mode.
4. Go to [page 30](#) and scan the bar code: SELECT INTERCHARACTER DELAY SETTING.
5. Scan the appropriate two digits from the keypad in [Appendix D, Keypad](#), that represent the duration which was determined in the steps above. You will hear a two-beep indication after the last character.



If you make a mistake before the last character, scan the CANCEL bar code to abort and not save the entry string. You can then start again at the beginning.

6. Scan the ENTER/EXIT PROGRAMMING MODE bar code to exit.

This completes the procedure. See [Table 31](#) for some examples of how to set this feature.

Table 31. Intercharacter Delay Setting Examples

STEP	ACTION	EXAMPLES			
1	Desired Setting	50ms	150ms	600ms	850ms
2	Divide by 10 (pad with leading zeroes to yield two-digits)	05	15	60	85
3	Scan ENTER/EXIT PROGRAMMING MODE				
4	Scan SELECT INTERCHARACTER DELAY SETTING				
5	Scan Two Characters From Appendix D, Keypad	'0' and '5'	'5' and '0'	'6' and '0'	'8' and '5'
6	Scan ENTER/EXIT PROGRAMMING MODE				

ACK NAK Options

This enables/disables the ability of the reader to support the RS-232 ACK/NAK protocol. When configured, the reader and/or host sends an “ACK” when it receives data properly, and sends “NAK” when the data is in error.

Options are:

- Disable
- Enable for label transmission — The reader expects an ACK/NAK response from the host when a label is sent.
- Enable for host-command acknowledge — The reader will respond with ACK/NAK when the host sends a command.
- Enable for label transmission and host-command acknowledge

ACK Character

This setting specifies an ASCII character or hex value to be used as the ACK character. ASCII characters or any hex value from 0 to 0xFF can be selected.

1. Determine the desired character or value.
2. Use the [ASCII Chart](#) on the inside back cover of this manual to find the hex equivalent for the desired character/value.
3. Go to [page 32](#) and scan ENTER/EXIT PROGRAMMING MODE to enter Programming Mode.
4. Scan the bar code: SELECT ACK CHARACTER SETTING.
5. Scan the appropriate two alphanumeric characters from the keypad in [Appendix D, Keypad](#), that represent the desired character/value in step 1 above. The second character will cause a two-beep indication.
6. Scan the ENTER/EXIT PROGRAMMING MODE bar code to exit.

See [Table 32](#) for some examples of how to set this feature.

Table 32. ACK Character Setting Examples

STEP	ACTION	EXAMPLES			
1	Desired Character/Value	ACK	\$	@	>
2	Hex equivalent from ASCII Chart	0x06	0x24	0x40	0x3E
3	Scan ENTER/EXIT PROGRAMMING MODE				
4	Scan SELECT ACK CHARACTER SETTING				
5	Scan Two Characters from Appendix D, Keypad	'0' and '6'	'2' and '4'	'4' and '0'	'3' AND 'E'
6	Scan ENTER/EXIT PROGRAMMING MODE				

NAK Character

This setting specifies an ASCII character or hex value to be used as the NAK character. ASCII characters or any hex value from 0 to 0xFF can be selected.

To set this feature:

1. Determine the desired character or value.
2. Use the [ASCII Chart](#) on the inside back cover of this manual to find the hex equivalent for the desired character/value.
3. Go to [page 32](#) and scan the ENTER/EXIT PROGRAMMING MODE bar code to enter Programming Mode.
4. Scan the bar code: SELECT NAK CHARACTER SETTING.
5. Scan the appropriate two alphanumeric characters from the keypad in [Appendix D, Keypad](#), that represent the desired character/value in step 1 above. The second character will cause a two-beep indication.
6. Scan the ENTER/EXIT PROGRAMMING MODE bar code to exit Programming Mode.

This completes the procedure. See [Table 33](#) for some examples of how to set this feature.

Table 33. NAK Character Setting Examples

STEP	ACTION	EXAMPLES			
1	Desired Character/Value	NAK	\$	@	>
2	Hex equivalent from ASCII Chart	0x15	0x24	0x40	0x3E
3	Scan ENTER/EXIT PROGRAMMING MODE				
4	Scan SELECT NAK CHARACTER SETTING				
5	Scan Two Characters From Appendix D, Keypad	'1' and '5'	'2' and '4'	'4' and '0'	'3' AND 'E'
6	Scan ENTER/EXIT PROGRAMMING MODE				

ACK NAK Timeout Value

This option specifies the amount of time the reader waits for an ACK character from the host following label transmission. The selectable timeout range is 200 milliseconds to 15,000ms (15 seconds) in 200ms increments. A selection of 0 disables the timeout.

To set this value:

1. Determine the desired setting in milliseconds.
2. Divide the desired setting by 200 (setting is in 200ms increments). Pad the result with leading zeroes to yield two digits. For example: 0 = 00, 5 = 05, 20 = 20, etc.
3. Go to [page 33](#) and scan the ENTER/EXIT PROGRAMMING MODE bar code to enter Programming Mode.
4. Scan the bar code: SELECT ACK NAK TIMEOUT VALUE SETTING.
5. Scan the appropriate two digits from the keypad in [Appendix D, Keypad](#), that represent the duration which was determined in the steps above. You will hear a two-beep indication after the last character.



If you make a mistake before the last character, scan the CANCEL bar code to abort and not save the entry string. You can then start again at the beginning.

6. Scan the ENTER/EXIT PROGRAMMING MODE bar code to exit Programming Mode.

This completes the procedure. See [Table 34](#) for some examples of how to set this feature.

Table 34. ACK NAK Timeout Value Setting Examples

STEP	ACTION	EXAMPLES			
1	Desired Setting	200ms	1,000ms (1 sec.)	5200ms (5.2 sec.)	15,000ms (15 sec.)
2	Divide by 200	01	05	26	75
3	Scan ENTER/EXIT PROGRAMMING MODE				
4	Scan SELECT ACK NAK TIMEOUT VALUE SETTING				
5	Scan Two Characters From Appendix D, Keypad	'0' and '1'	'0' and '5'	'2' and '6'	'7' and '5'
6	Scan ENTER/EXIT PROGRAMMING MODE				

ACK NAK Retry Count

This feature specifies the number of times the reader retries a label transmission due to a retry condition. The selectable range is from 1 to 254 retries. A selection of 0 disables the count, and a selection of 255 specifies unlimited retries.

To set this feature:

1. Determine the desired setting.
2. Pad the number with leading zeroes to yield three digits. For example: 0 = 000, 5 = 005, 20 = 020, etc.
3. Go to [page 33](#) and scan the ENTER/EXIT PROGRAMMING MODE bar code to enter Programming Mode.
4. Scan the bar code: SELECT ACK NAK RETRY COUNT SETTING.
5. Scan the appropriate three digits from the keypad in [Appendix D, Keypad](#), that represent the number which was determined in the steps above. You will hear a two-beep indication after the last character.



If you make a mistake before the last character, scan the CANCEL bar code to abort and not save the entry string. You can then start again at the beginning.

6. Scan the ENTER/EXIT PROGRAMMING MODE bar code to exit Programming Mode.

This completes the procedure. See [Table 35](#) for some examples of how to set this feature.

Table 35. ACK NAK Retry Count Setting Examples

STEP	ACTION	EXAMPLES			
1	Desired Setting	Disable Retry Count	3 Retries	54 Retries	Unlimited Retries
2	Pad with leading zero(es)	000	003	054	255
3	Scan ENTER/EXIT PROGRAMMING MODE				
4	Scan SELECT ACK NAK RETRY COUNT SETTING				
5	Scan Three Characters From Appendix D, Keypad	'0', '0' and '0'	'0', '0' and '3'	'0', '5' and '4'	'2', '5' and '5'
6	Scan ENTER/EXIT PROGRAMMING MODE				

Disable Character

Specifies the value of the RS-232 host command used to disable the reader. ASCII characters or any hex value from 0 to 0xFF can be selected.

To set the value:

1. Determine the desired character or value. A setting of 0xFF indicates the Disable Character is not used (not available).
2. Use the [ASCII Chart](#) on the inside back cover of this manual to find the hex equivalent for the desired character/value.
3. Go to [page 35](#) and scan the ENTER/EXIT PROGRAMMING MODE bar code to enter Programming Mode.
4. Scan the bar code: SELECT DISABLE CHARACTER SETTING.
5. Scan the appropriate two alphanumeric characters from the keypad in [Appendix D, Keypad](#), that represent the desired character/value in step 1 above. The second character will cause a two-beep indication.
6. Scan the ENTER/EXIT PROGRAMMING MODE bar code to exit Programming Mode.

This completes the procedure. See [Table 36](#) for some examples of how to set this feature.

Table 36. Disable Character Setting Examples

STEP	ACTION	EXAMPLES			
1	Desired character/value	'd'	'}'	'D'	Disable Command Not Used
2	Hex equivalent from ASCII Chart	0x64	0x7D	0x44	0xFF
3	Scan ENTER/EXIT PROGRAMMING MODE				
4	Scan SELECT DISABLE CHARACTER VALUE SETTING				
5	Scan Two Characters From Appendix D, Keypad	'6' and '4'	'7' and 'D'	'4' and '4'	'F' AND 'F'
6	Scan ENTER/EXIT PROGRAMMING MODE				

Enable Character

Specifies the value of the RS-232 host command used to enable the reader. ASCII characters or any hex value from 0 to 0xFF can be selected.

To set this feature:

Determine the desired character or value. A setting of 0xFF indicates the Enable Character is not used (not available).

1. Determine the desired character or value.
2. Use the [ASCII Chart](#) on the inside back cover of this manual to find the hex equivalent for the desired character/value.
3. Go to [page 35](#) and scan the ENTER/EXIT PROGRAMMING MODE bar code to enter Programming Mode.
4. Scan the bar code: SELECT ENABLE CHARACTER SETTING.
5. Scan the appropriate two alphanumeric characters from the keypad in [Appendix D, Keypad](#), that represent the desired character/value in step 2 above. The second character will cause a two-beep indication.
6. Scan the ENTER/EXIT PROGRAMMING MODE bar code to exit Programming Mode.

This completes the procedure. See [Table 37](#) for some examples of how to set this feature.

Table 37. Enable Character Setting Examples

STEP	ACTION	EXAMPLES			
1	Desired character/value	'e'	'}'	'E'	Enable Command Not Used
2	Hex equivalent from ASCII Chart	0x65	0x7D	0x45	0xFF
3	Scan ENTER/EXIT PROGRAMMING MODE				
4	Scan SELECT ENABLE CHARACTER VALUE SETTING				
5	Scan Two Characters From Appendix D, Keypad	'6' and '5'	'7' and 'D'	'4' and '5'	'F' AND 'F'
6	Scan ENTER/EXIT PROGRAMMING MODE				

Keyboard Interface

Wedge Quiet Interval

Specifies the amount of time the reader looks for keyboard activity before it breaks the keyboard connection in order to transmit data to host. The range is from 0 to 990ms in 10ms increments.



This feature applies **ONLY** to the Keyboard Wedge interface.

1. Determine the desired setting in milliseconds.
2. Divide the desired setting by 10 (setting is in 10ms increments). Pad the result with leading zeroes to yield two digits. For example: 0 = 00, 5 = 05, 20 = 20, etc.
3. Go to [page 42](#) and scan the ENTER/EXIT PROGRAMMING MODE bar code to enter Prog. Mode.
4. Scan the bar code: SELECT WEDGE QUIET INTERVAL SETTING.
5. Scan the appropriate two digits from the keypad in [Appendix D, Keypad](#), that represent the duration which was determined in the steps above. You will hear a two-beep indication after the last character.



If you make a mistake before the last character, scan the CANCEL bar code to abort and not save the entry string. You can then start again at the beginning.

6. Scan the ENTER/EXIT PROGRAMMING MODE bar code to exit.

This completes the procedure to set the Wedge Quiet Interval. See [Table 38](#) for some examples of how to set this feature.

Table 38. Wedge Quiet Interval Setting Examples

STEP	ACTION	EXAMPLES			
1	Desired Setting	10ms	150ms	600ms	850ms
2	Divide by 10 (and pad with leading zeroes)	01	15	60	85
3	Scan ENTER/EXIT PROGRAMMING MODE				
4	Scan SELECT WEDGE QUIET INTERVAL SETTING				
5	Scan Two Characters From Appendix D, Keypad	'0' and '1'	'1' and '5'	'6' and '0'	'8' and '5'
6	Scan ENTER/EXIT PROGRAMMING MODE				

Intercharacter Delay

This parameter specifies the intercharacter delay between the end of one character and the beginning of the next. The delay can be set within a range of zero (0) to 990 milliseconds in 10ms increments. A setting of zero specifies no delay.



This feature applies **ONLY** to the Keyboard Wedge interface.

To set the delay:

1. Determine the desired setting in milliseconds.
2. Divide the desired setting by 10 (setting is in 10ms increments). Pad the result with leading zeroes to yield two digits. For example: 0 = 00, 5 = 05, 20 = 20, etc.
3. Go to [page 30](#) and scan the ENTER/EXIT PROGRAMMING MODE bar code to enter Programming Mode.
4. Scan the bar code: SELECT INTERCHARACTER DELAY SETTING.
5. Scan the appropriate two digits from the keypad in [Appendix D, Keypad](#), that represent the duration which was determined in the steps above. You will hear a two-beep indication after the last character.



If you make a mistake before the last character, scan the CANCEL bar code to abort and not save the entry string. You can then start again at the beginning.

6. Scan the ENTER/EXIT PROGRAMMING MODE bar code to exit Programming Mode.

This completes the procedure. See [Table 39](#) for some examples of how to set this feature.

Table 39. Intercharacter Delay Setting Examples

STEP	ACTION	EXAMPLES			
1	Desired Setting	50ms	150ms	600ms	850ms
2	Divide by 10 (and pad with leading zeroes to yield two-digits)	05	15	60	85
3	Scan ENTER/EXIT PROGRAMMING MODE				
4	Scan SELECT INTERCHARACTER DELAY SETTING				
5	Scan Two Characters From Appendix D, Keypad	'0' and '5'	'1' and '5'	'6' and '0'	'8' and '5'
6	Scan ENTER/EXIT PROGRAMMING MODE				

Intercode Delay

Specifies the delay between labels transmitted to the host for this interface. The selectable range for this feature is from 0 to 99 seconds.

Follow these instructions to set this feature:

1. Determine the desired setting.
2. Pad the number with leading zeroes to yield two digits. For example: 0 = 00, 5 = 05, 20 = 20, etc
3. Go to [page 42](#) and scan the ENTER/EXIT PROGRAMMING MODE bar code to enter Programming Mode.
4. Scan the bar code: SELECT INTERCODE DELAY SETTING.
5. Scan the appropriate two digits from the keypad in [Appendix D, Keypad](#), that represent the duration which was determined in the steps above. You will hear a two-beep indication after the last character.



If you make a mistake before the last character, scan the CANCEL bar code to abort and not save the entry string. You can then start again at the beginning.

6. Scan the ENTER/EXIT PROGRAMMING MODE bar code to exit Programming Mode.

This completes the procedure. See [Table 40](#) for some examples of how to set this feature.

Table 40. Wedge Intercode Delay Examples

STEP	ACTION	EXAMPLES			
1	Desired Setting	No Delay	5 Seconds	60 Seconds	99 Seconds
2	Pad with leading zero(es)	00	05	60	99
3	Scan ENTER/EXIT PROGRAMMING MODE				
4	Scan SELECT INTERCODE DELAY SETTING				
5	Scan Two Characters From Appendix D, Keypad	'0' and '0'	'0' and '5'	'6' and '0'	'9' AND '9'
6	Scan ENTER/EXIT PROGRAMMING MODE				

Symbologies

Decoding Safety

Decoding Safety is used to configure a decoder to be very aggressive to very conservative, depending on a particular customer's needs.

- Level 1 results in a very aggressive decoder.
- Level 5 results in a very conservative decoder at the expense of not being able to read poorly printed or damaged labels.

There are many factors that determine when to change the decoding safety. These factors include spots, voids, non-uniform backgrounds, damaged labels, etc. that may be experienced in some barcode labels. If there are many hard to read or damaged labels that cannot be decoded using a conservative setting, decrease the decoding safety to be more aggressive. In case of rigorous reliability application requirements it is suggested to use higher decoding safety values (conservative).

Set Length

Length Control allows you to select either variable length decoding or fixed length decoding for the specified symbology.

Variable Length: For variable length decoding, a minimum and maximum length may be set.

Fixed Length: For fixed length decoding, two different lengths may be set.

Set Length 1

This feature specifies one of the bar code lengths for Length Control. Length 1 is the minimum label length if in Variable Length Mode, or the first fixed length if in Fixed Length Mode. Length includes the bar code's data characters only.

The number of characters that can be set varies, depending on the symbology. Reference the page for your selected symbology to see specific variables.

1. Determine the desired character length (varies depending on symbology). Pad the number with leading zeroes to yield two digits. For example: 0 = 00, 5 = 05, 20 = 20, etc.
2. Go to the Set Length page for your selected symbology and scan the ENTER/EXIT PROGRAMMING MODE bar code to enter Programming Mode.
3. Scan the bar code to SELECT LENGTH 1 SETTING for your selected symbology.
4. Scan the appropriate two digits from the keypad in [Appendix D, Keypad](#), that represent the length setting which was determined in the steps above. You will hear a two-beep indication after the last character.



If you make a mistake before the last character, scan the CANCEL bar code to abort and not save the entry string. You can then start again at the beginning.

5. Scan the ENTER/EXIT PROGRAMMING MODE bar code to exit Prog Mode.

Set Length 2

This feature allows you to set one of the bar code lengths for the specified symbology. Length 2 is the maximum label length if in [Variable Length Mode](#), or the second fixed length if in [Fixed Length Mode](#). See the page for the specific symbology for parameters.

The length that can be set varies depending on the symbology. A setting of 0 specifies to ignore this length (only one fixed length).

Follow these instructions to set this feature:

1. Determine the desired character length (from 1 to 50 — or 0 to ignore this length). Pad the number with leading zeroes to yield two digits. For example: 0 = 00, 5 = 05, 20 = 20, etc.
2. Go to the Set Length page for your selected symbology and scan the ENTER/EXIT PROGRAMMING MODE bar code to enter Programming Mode.
3. Scan the bar code to SELECT LENGTH 2 SETTING for your selected symbology.
4. Scan the appropriate two digits from the keypad in [Appendix D, Keypad](#) that represent the length setting which was determined in the steps above. You will hear a two-beep indication after the last character.



If you make a mistake, before the last character scan the CANCEL bar code to abort and not save the entry string. You can then start again at the beginning.

5. Scan the ENTER/EXIT PROGRAMMING MODE bar code to exit Programming Mode.

This completes the procedure.

Data Editing

When a bar code is scanned, additional information can be sent to the host computer along with the bar code data. This combination of bar code data and supplementary user-defined data is called a “message string.” The Data Editing features can be used to build specific user-defined data into a message string.

There are several types of selectable data characters that can be sent before and after scanned data. You can specify if they should be sent with all symbologies, or only with specific symbologies. Figure 7 shows the available elements you can add to a message string:

Figure 7. Breakdown of a Message String

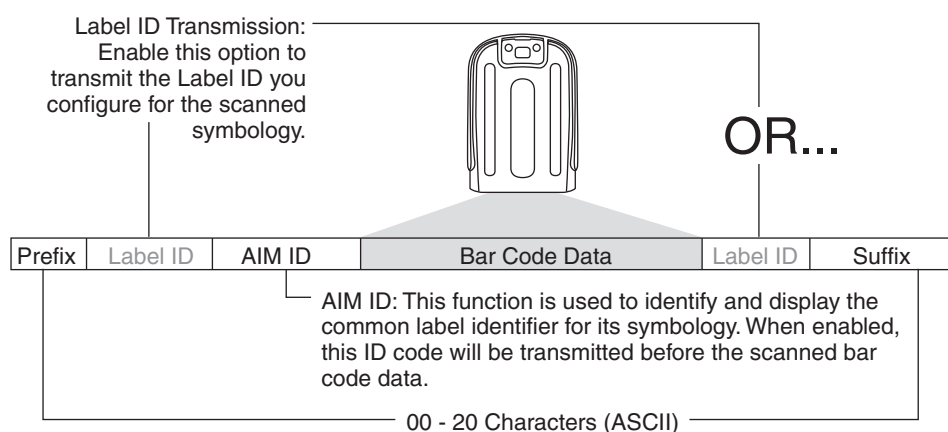

Additional advanced editing is available. See the Advanced formatting features in the Datalogic Aladdin configuration software, or contact Technical Support (as described on [page 2](#)) for more information.

Please Keep In Mind...

- Modifying a message string is not a mandatory requirement. Data editing is a sophisticated feature allowing highly customizable output for advanced users. Factory default settings for data editing is typically set to NONE.
- A prefix or suffix may be applied only to a specified symbology (reference [Symbologies, starting on page 75](#) or across all symbologies (set via the Global features in this chapter).
- You can add any character from the [ASCII Chart](#) (from 00–FF) on the inside back cover of this manual as a prefix, suffix or Label ID.
- Enter prefixes and suffixes in the order in which you want them to appear on the output.

Global Prefix/Suffix

Up to 20 ASCII characters may be added as a prefix (in a position before the bar code data) and/or as a suffix (in a position following the bar code data) as indicated in Figure 8.

Figure 8. Prefix and Suffix Positions

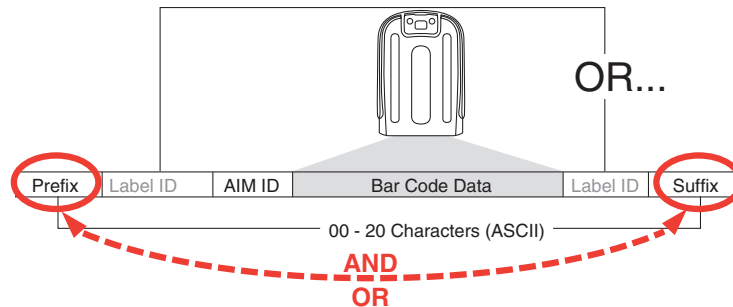

Example: Setting a Prefix

In this example, we'll set a prefix for all symbologies.

1. Determine which ASCII character(s) are to be added to scanned bar code data. In this example, we'll add a dollar sign ('\$') as a prefix.
2. Go to [page 50](#) and scan the ENTER/EXIT PROGRAMMING MODE bar code, then scan the SET GLOBAL PREFIX bar code.
3. Reference the [ASCII Chart](#) on the inside back cover of this manual to find the hex value assigned to the desired character. The corresponding hex number for the '\$' character is 24. To enter this selection code, scan the '2' and '4' bar codes from [Appendix D, Keypad](#).



If you make a mistake before the last character, scan the CANCEL bar code to abort and not save the entry string. You can then start again at the beginning.

4. If less than the expected string of 20 characters are selected, scan the ENTER/EXIT bar code to terminate the string.
5. Scan the ENTER/EXIT bar code once again to exit Programming Mode.
6. The resulting message string would appear as follows:
Scanned bar code data: 12345
Resulting message string output: \$12345

Global AIM ID



This feature enables/disables addition of AIM IDs for all symbology types.

AIM label identifiers (as opposed to custom characters you select yourself as with label identifiers) can be included with scanned bar code data. AIM label identifiers consist of three characters as follows:

- A close brace character (ASCII '['), followed by...
- A code character (see the table below), followed by...
- A modifier character (the modifier character is symbol dependent).

SYMBOLGY	CHAR	SYMBOLGY	CHAR
UPC/EAN	E ^a	Code 128/GS1-128	C
Code 39 and Code 32	A	DataBar Omnidirectional, DataBar Expanded	e
Codabar	F	Standard 2 of 5	S
Interleaved 2 of 5	I	ISBN	X ^b
Code 93	G	Code 11	H

- UPC-A and UPC-E labels are converted to EAN 13 when adding AIM IDs.
- ISBN (X with a 0 modifier character)

Figure 9. AIM ID

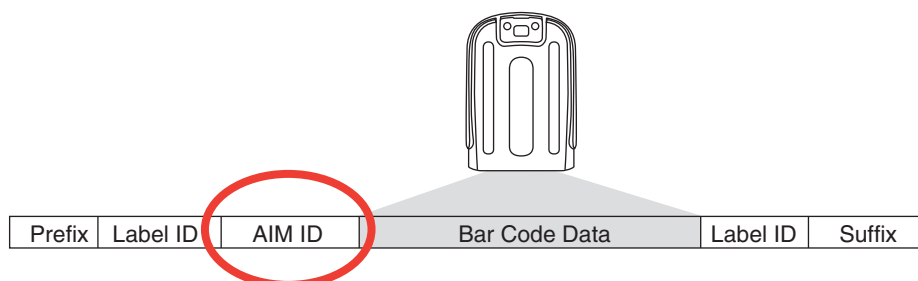

Label ID

A Label ID is a customizable code of up to three ASCII characters (each can be one of hex 0x01–0xFF), used to identify a bar code (symbology) type. It can be appended previous to or following the transmitted bar code data depending upon how this option is enabled. This feature provides options for configuring custom Label IDs as a pre-loaded set (see "Label ID: Pre-loaded Sets" below) or individually per symbology (see "Label ID: Set Individually Per Symbology" on page 304). If you wish to program the reader to always include an industry standard label identifier for ALL symbology types, see "Global AIM ID" on page 51.

Label ID: Pre-loaded Sets

The reader supports two pre-loaded sets of Label IDs. Table 41 shows the USA and the EU sets.



When changing from one Label ID set to another, all other reader configuration settings, including the host interface type, will be erased and set to the standard factory defaults. Any custom configuration or custom defaults will be lost.

Table 41. Label ID Pre-loaded Sets

Symbology	USA Label ID set		EU Label ID set	
	Default Character	Default ASCII	Default Character	Default ASCII
CODABAR	%	250000	R	520000
CODE11	CE	434500	b	620000
CODE128	#	230000	T	540000
CODE32	A	410000	X	580000
CODE39	*	2A0000	V	560000
CODE39 CIP	Y	590000	Y	590000
CODE93	&	260000	U	550000
DATABAR 14	R4	523400	u	750000
DATABAR 14 COMPOSITE	R4	523400	c	523400
DATABAR EXPANDED	RX	525800	t	740000
DATABAR EXPANDED COMPOSITE	RX	525800	d	525800
DATABAR LIMITED	RL	524C00	v	760000
DATABAR LIMITED COMPOSITE	RL	524C00	i	524C00
EAN128		000000	k	6B0000
EAN128 COMPOSITE		000000	\$E	244500
EAN13	F	460000	B	420000
EAN13 P2	F	460000	L	4C0000

Symbology	USA Label ID set		EU Label ID set	
	Default Character	Default ASCII	Default Character	Default ASCII
EAN13 P5	F	460000	M	4D0000
EAN13 COMPOSITE	F	460000	\$F	244600
EAN8	FF	464600	A	410000
EAN8 P2	FF	464600	J	4A0000
EAN8 P5	FF	464600	K	4B0000
EAN8 COMPOSITE	FF	464600	\$G	244700
FOLLET 2OF5	O	4F0000	O	4F0000
GTIN	G	470000	\$A	244100
GTIN2	G2	473200	\$B	244200
GTIN5	G5	473500	\$C	244300
I2OF5	i	690000	N	4E0000
IATA INDUSTRIAL 2OF5 (Only standard optic models)	IA	494100	&	260000
INDUSTRIAL 2OF5	W	570000	W	570000
ISBN	l	490000	@	400000
ISBT128 CONCAT	f	660000	f	660000
ISSN	n	6E0000	n	6E0000
MSI	@	400000	Z	5A0000
PLESSEY	a	610000	a	610000
S25	s	730000	P	500000
UPCA	A	410000	C	430000
UPCA P2	A	410000	F	460000
UPCA P5	A	410000	G	470000
UPCA COMPOSITE	A	410000	\$H	244800
UPCE	E	450000	D	440000
UPCE P2	E	450000	H	480000
UPCE P5	E	450000	I	490000
UPCE COMPOSITE	E	450000	\$J	244A00

Label ID: Set Individually Per Symbology

To configure a Label ID individually for a single symbology:

1. Go to [page 55](#) and scan the ENTER/EXIT bar code.
2. Select Label ID position as either BEFORE (Enable as Prefix) or AFTER (Enable as suffix) by scanning the appropriate bar code in the section [Label ID Control on page 55](#). Reference [Figure 10](#) for Label ID positioning options if multiple identification features are enabled.
3. Scan a bar code to select the symbology for which you wish to configure a custom Label ID from the section ["Label ID Symbology Selection"](#) on [page 56](#).
4. Determine the desired character(s) (you may choose up to three) which will represent the Label ID for the selected symbology.
5. Turn to the [ASCII Chart](#) on the inside back cover of this manual and find the equivalent hex digits associated with your choice of Label ID. For example, if you wish to select an equal sign (=) as a Label ID, the chart indicates its associated hex characters as 3D. Turn to [Keypad, starting on page 343](#) and scan the bar codes representing the hex characters determined. For the example given, the characters '3' and 'D' would be scanned. More examples of Label ID settings are provided in [Table 42](#).



If you make a mistake before the last character, scan the CANCEL bar code to abort and not save the entry string. You can then start again at the beginning.

6. Scan the ENTER/EXIT bar code to exit Label ID entry.
 7. Scan the ENTER/EXIT bar code once again to exit Programming Mode.
- This completes the steps to configure a Label ID for a given symbology.

Figure 10. Label ID Position Options

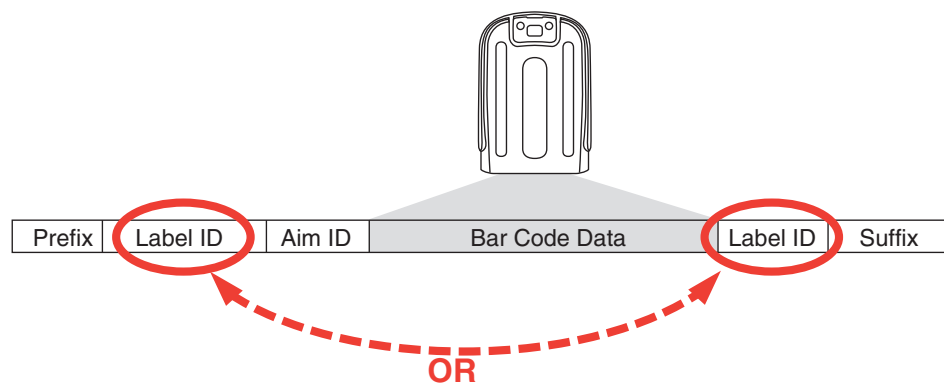

Table 42. Label ID Examples

STEP	ACTION	EXAMPLES			
1.	Scan the ENTER/EXIT bar code	(Scanner enters Programming Mode)			
2.	Determine placement of the Label ID characters BEFORE or AFTER with regard to scanned data using Label ID Control, starting on page 55	Enable as Prefix	Enable as Suffix	Enable as Prefix	Enable as Suffix
3.	Scan the bar code selecting the symbology type you wish to designate label ID characters for using Label ID Symbology Selection, starting on page 56.	DataBar Omnidirectional	Code 39	Interleaved 2 of 5	Code 32
4.	Custom Label ID example (desired characters):	D B *	= C 3	+	PH
5.	Find hex equivalents from the ASCII Chart (inside back cover), then scan in these digits/characters using the bar codes in the section: Keypad, starting on page 343. If you make a mistake before the last character, scan the CANCEL bar code to abort and not save the entry string. You can then start again at the beginning.	44 42 2A	3D 43 33	2B	50 48
6.	Scan the ENTER/EXIT bar code	(Scanner exits Label ID entry)			
7.	Scan the ENTER/EXIT bar code once again	(Scanner exits Programming Mode)			
Result:		DB*[bar code data]	[bar code data]=C3	+ [bar code data]	[bar code data]PH

Character Conversion

Character conversion is an eight byte configuration item. The eight bytes are 4 character pairs represented in hexadecimal ASCII values. The first character in the pair is the character that will be converted. The second character in the pair is the character to convert to. If the character to convert in a pair is FF, then no conversion is done.

For example, if you have the character conversion configuration item set to the following: 41423132FFFFFFF

The first pair is 4142 or AB (41 hex is an ASCII capital A, 42 hex is an ASCII capital B) and the second pair is 3132 or 12 (31 hex is an ASCII 1, 32 is an ASCII 2). The other two pairs are FFFF and FFFF.

With the label, AB12BA21, it would look as follows after the character conversion: BB22BB22.

The A characters were converted to B characters and the 1 characters were converted to 2 characters. Nothing is done with the last two character pairs, since they are all FF.

To set Character Conversion:

1. Go to [page 62](#) and scan the ENTER/EXIT bar code.
2. Scan the “Configure Character Conversion” bar code.
3. Determine the desired string. Sixteen positions must be determined as in the above example. Next, turn to the [ASCII Chart](#) on the inside back cover of this manual and find the equivalent hex digits needed to fulfill the string.
4. Turn to [Appendix D, Keypad](#) and scan the bar codes representing the hex characters determined in the previous step.
5. Scan the ENTER/EXIT bar code to exit Programming Mode.



If less than the expected string of 16 characters are selected, scan the ENTER/EXIT bar code twice to accept the selections and exit Programming Mode.

Reading Parameters

Good Read LED Duration

This feature specifies the amount of time that the Good Read LED remains on following a good read. The good read LED on time can be set within a range of 10 milliseconds to 2,550 milliseconds (0.001 to 2.55 seconds) in 100ms increments.

Follow these instructions to set this feature:

1. Determine the desired setting in milliseconds. A setting of 0 means that the good read LED stays on until the next time the trigger is pulled.
2. Divide the desired setting by 10 (setting is in 100ms increments). Pad the result with leading zeroes to yield three digits. For example: 0 = 000, 5 = 000, 20 = 020, etc.
3. Go to [page 70](#) and scan the ENTER/EXIT PROGRAMMING MODE bar code to enter Programming Mode.
4. Scan the bar code: SELECT GOOD READ LED DURATION SETTING.
5. Scan the appropriate three digits from the keypad in [Appendix D, Keypad](#) representing the duration which was determined in the steps above. You will hear a two-beep indication after the last character.



If you make a mistake before the last character, scan the CANCEL bar code to abort and not save the entry string. You can then start again at the beginning.

6. Scan the ENTER/EXIT PROGRAMMING MODE bar code to exit Programming Mode.

This completes the procedure. See [Table 43](#) for some examples of how to set this feature.

Table 43. Good Read LED Duration Setting Examples

STEP	ACTION	EXAMPLES			
1	Desired Setting	Good Read LED stays on until next trigger pull (00)	20ms	150ms	2550ms (2.55 sec.)
2	Divide by 10 (and pad with leading zeroes)	000	002	015	255
3	Scan ENTER/EXIT PROGRAMMING MODE				
4	Scan SELECT GOOD READ LED DURATION SETTING				
5	Scan Three Characters From Appendix D, Keypad	'0', '0' and '0'	'0', '0' and '2'	'0', '1' and '5'	'2', '5' and '5'
6	Scan ENTER/EXIT PROGRAMMING MODE				

Scanning Features

Scan Mode

This mode is associated with typical handheld reader operation. Selects the scan operating mode for the reader. The following selections are valid for all models:

Trigger Single: When the trigger is pulled, scanning is activated until one of the following occurs:

- a label has been read
- the trigger is released

Trigger Hold Multiple: When the trigger is pulled, scanning starts and the product scans until the trigger is released. Reading a label does not disable scanning. **Double Read Timeout** prevents undesired multiple reads of the same label while in this mode.

Trigger Pulse Multiple: When the trigger is pulled, continuous scanning is activated until the trigger has been released and pulled again. **Double Read Timeout** prevents undesired multiple reads of the same label while in this mode.

Flashing: The reader flashes on and off regardless of the trigger status. When Flash is ON the scanner reads continuously; when Flash is OFF scanning is deactivated.

Always On: No trigger pull is required to read a bar code. Scanning is continually on. If the trigger is pulled, the reader acts as if it is in Trigger Single Mode. **Double Read Timeout** prevents undesired multiple reads of the same label while in this mode.

Table 44. Symbology Hex Values

Hex Value	Symbology ID	Hex Value	Symbology ID
00	Don't care	2C	GTIN5
01	UPC-A	2D	GTIN8
02	UPC-E	2E	S2OF5
03	EAN8	2F	PDF417
04	EAN13	30	CODE11
05	UPC2	31	IATA
06	UPC5	32	MICRO_PDF
07	C128_ADDON	33	GS1 DataBar_LIM_ID
0A	EAN128	34	GS1 DataBar_LIM_COMP
0B	C128_PROGRAMMING_LABEL	35	GS1 DataBar_Omnidirectional_COMP
0C	CODE128	36	GS1 DataBar_EXP_COMP
0D	FNC3_C128_LABEL	37	GENERIC_DATA
0E	DATA MATRIX	38	CC_A
0F	MAXICODE	39	CC_B
10	QRCODE	3A	CC_C
11	Reserved	3B	LABELIMAGE
12	Reserved	3C	CAPTURE_IMAGE_LABEL
13	CODE49	3D	Reserved
14	UPC-E2	3E	M2OF5
15	UPC-E5	3F	D2OF5
16	Reserved	40	PLESSEY65
17	UPC-A2	42	ISSN
18	UPC-A5	43	ISBT
19	Reserved	44	Reserved
1A	EAN82	45	TIMER_EXPIRED_EVENT
1B	EAN85	46	FOLLETT_2OF5
1C	Reserved	47	Reserved
1D	EAN132	48	Reserved
1E	EAN135	49	CODE39_CIP
1F	EAN138	4A	ABC_CODABAR
20	ISBN_ID	4B	I2OF5_CIP
21	TWO_LABEL_PAIR	4C	C2OF5
22	I2OF5	4D	IND2OF5
23	CODABAR	4E	AZTEC
24	CODE39	4F	UPC-E_COMP
25	PHARMAC39	50	UPC-A_COMP
26	MSI_PLESSEY	51	EAN8_COMP
27	CODE93	52	EAN13_COMP
28	RSS_EXP_ID	53	EAN128_COMP
29	RSS_14_ID	54	DATA MATRIX_PROGRAMMING_LABEL
2A	GTIN	55	LABEL_ID_MAX
2B	GTIN2	FF	INVALID_LABEL_TYPE

Wireless Features

Automatic Configuration Update

When this feature is enabled, the base station and reader will keep their configurations synchronized. If a reader's configuration is altered by reading programming labels, this change is automatically transferred and updated in a linked base station. Likewise, if the base station's configuration is changed using Aladdin or by host commands, then the reader's configuration will automatically be updated if this feature is enabled.

RF Address Stamping

Source Radio Address Delimiter Character

This option specifies the delimiter character to be placed between the label data and radio address when address stamping is enabled.



This feature only applies if **Source Radio Address Transmission** on page 227 is enabled.

Follow these instructions to select the delimiter character:

1. Determine the desired character, then find its hexadecimal equivalent on the [ASCII Chart](#) on the inside back cover. A setting of 00 specifies no delimiter character.
2. Go to [page 228](#) and scan the ENTER/EXIT PROGRAMMING MODE bar code to enter Programming Mode.
3. Scan the bar code: SET SOURCE RADIO ADDRESS DELIMITER CHARACTER.
4. Scan the appropriate two digits from the keypad in [Appendix D, Keypad](#), that represent the hexadecimal characters which were determined in the steps above. You will hear a two-beep indication after the last character.



If you make a mistake before the last character, scan the CANCEL bar code to abort and not save the entry string. You can then start again at the beginning.

5. Scan the ENTER/EXIT PROGRAMMING MODE bar code to exit.

Table 45. Source Radio Address Delimiter Character Setting Examples

STEP	ACTION	EXAMPLES			
1	Desired Setting	No delimiter character	, (comma)	- (dash)	/ (slash)
2	Scan ENTER/EXIT PROGRAMMING MODE				
3	Scan SET SOURCE RADIO ADDRESS DELIMITER CHARACTER				
4	Scan Two Characters From Appendix D, Keypad	'0' and '0'	'2' and 'C'	'2' and 'D'	'2' AND 'F'
5	Scan ENTER/EXIT PROGRAMMING MODE				

STAR Radio Protocol Timeout

This parameter sets the valid wait time before transmission between the handheld reader and Base Station is considered failed.

When setting this parameter, take into consideration the radio traffic (number of readers in the same area). The selectable range for this feature is from 02 to 25 seconds.

Follow these instructions to set this feature:

1. Determine the desired setting.
2. Pad the number with leading zeroes to yield two digits. For example: 2 = 02, 5 = 05, 25 = 25, etc
3. Go to [page 247](#) and scan the ENTER/EXIT PROGRAMMING MODE barcode to enter Programming Mode.
4. Scan the barcode: SELECT RADIO PROTOCOL TIMEOUT.
5. Scan the appropriate two digits from the keypad in [Appendix D, Keypad](#), that represent the duration which was determined in the steps above. You will hear a two-beep indication after the last character.



If you make a mistake before the last character, scan the CANCEL barcode to abort and not save the entry string. You can then start again at the beginning.

6. Scan the ENTER/EXIT PROGRAMMING MODE barcode to exit Programming Mode.

This completes the procedure. See [Table 46](#) for some examples of how to set this feature.

Table 46. STAR Radio Protocol Timeout Examples

STEP	ACTION	EXAMPLES			
1	Desired Setting	2 Seconds	5 Seconds	10 Seconds	25 Seconds
2	Pad with leading zero(es)	02	05	10	25
3	Scan ENTER/EXIT PROGRAMMING MODE				
4	Scan SELECTSTAR RADIO PROTOCOL TIMEOUT SETTING				
5	Scan Two Characters From Appendix D, Keypad	'0' and '2'	'0' and '5'	'1' and '0'	'2' AND '5'
6	Scan ENTER/EXIT PROGRAMMING MODE				

Bluetooth-Only Features

Bluetooth Pin Code

This option specifies the 4-character or 16-character pin code to be used for authentication of the Bluetooth link. To set the pin code:

1. Scan the ENTER/EXIT PROGRAMMING MODE bar code to enter Programming Mode, then enable [Bluetooth Security Mode on page 235](#).
2. Specify the desired pin code length (4 or 16) by scanning the appropriate bar code in [Select PIN Code Length on page 235](#).
3. Determine the desired characters. For example, D254 or STOR12345678135M.
4. Convert the characters to hexadecimal using the [ASCII Chart](#) on the inside back cover of this manual.
5. Go to [page 235](#) and Scan the bar code: SET 4 CHAR PIN CODE or SET 16-CHAR PIN CODE.
6. Scan the appropriate alphanumeric characters from the keypad in [Appendix D, Keypad](#), representing the hexadecimal entries determined in the steps above. You will hear a two-beep indication after the last character.



If you make a mistake before the last character, scan the CANCEL bar code to abort and not save the entry string. You can then start again at the beginning.

7. Scan the ENTER/EXIT PROGRAMMING MODE bar code to exit Programming Mode.



Changing the pin code setting will unlink the devices. If the Automatic Configuration Update is set to the default enabled setting, the devices must only be relinked. If the Automatic Configuration Update is set to the disabled setting, the Pin Code setting must also be updated in the Base Station using Aladdin. After the Base Station has been updated, the devices must be relinked.

Table 47. Bluetooth Pin Code Setting Examples

STEP	ACTION	EXAMPLES	
1	Desired Setting	D254	STOR12345678135M
2	Convert the characters to hexadecimal	44 32 35 34	53 54 4F 52 31 32 33 34 35 36 37 38 31 33 35 4D
3	Scan ENTER/EXIT PROGRAMMING MODE		
4	Scan SET Bluetooth PIN CODE		
5	Scan 8 or 32 Alphanumeric Characters From Appendix D, Keypad	44323534	53544F5231323334353637383133354D
6	Scan ENTER/EXIT PROGRAMMING MODE		



Chapter 5

Message Formatting



Message Formatting is available for PM9300 models only.

For this feature to be operational, the scanner must be set to Ignore Host Commands (see [page 23](#)).

A message from the Host to the base must follow these rules:

- If Address stamping options or address delimiter are enabled on the base, the Host replay must have address field and delimiter too. Otherwise the message will be ignored. Address delimiter is present only when address stamping is enabled.
- Address stamping is necessary to correctly route the message to the PM9300, especially when more than one handheld is linked to the same base. Address stamping could be disabled if the system is in point to point configuration. If address stamping is not enabled, the messages are addressed to the first handheld linked to the base.
- The maximum character length for messages is 48.
- Messages end with “CR” 0x0D ASCII character. The CR character cannot be contained in the middle.
- Messages cannot start with '\$' or # because these are reserved for Service mode command
- Base station can receive host message only if Host Commands Obey/Ignore is set to Ignore.
- Message could be sent to the handheld in response to a Label when “Transmit mode” require Ack from Host (see transmit mode parameter) or at any time. When messages are sent not in response to a label must start with DC2 0x12 ASCII character and could be sent in any transmit mode setting.
- Message could be sent to all handhelds linked to the base by using a Multicast message:
“00 00 00 00 2A AA”
- In order to receive a message, handhelds must not be in sleep state.

The format of the ACK from Host message (used for transmission mode 02) is:
[Scanner_Addr] [Scanner_Addr_delimiter] MESSAGE <CR>

The format of a generic message From Host to HH is:

[Scanner_Addr] [Scanner_Addr_delimiter] DC2 MESSAGE <CR>

where DC2 is ASCII 0x12 (^R) character.

[Items in square brackets are optional.]

- If you want to control the Scanner's beeper from the host, you will also probably want to disable the good transmission beep that is emitted when the code is received from the cradle. (See [Wireless Beeper Features on page 217](#)).

The message field can store plain text and escape sequences.

- Escape sequences are interpreted as commands.

Cursor Control

ESC [n A	Up <i>n</i> rows, no scroll
ESC [n B	Down <i>n</i> rows, no scroll
ESC [n C	Right <i>n</i> columns
ESC [n D	Left <i>n</i> columns
ESC [G	CR
ESC [r ; c H	Move to row <i>r</i> , column <i>c</i> (ESC[1;1H is the upper left character position of the display)
ESC D	Down 1 row, with scroll
ESC E	CR and cursor down 1 row with scroll
ESC M	Up 1 row and scroll



- Since CR is used as the message terminator, you must use ESC [G or ESC E to print a CR.
- The cursor row position is not affected by the currently selected font. The display always has 6 rows, so when writing with the large font, actually three rows are written. You will need two ESC E commands to step from one row to the next when using the large font.
- The cursor column position is affected by the currently selected font. Therefore, column 6 is 36 pixels from the left border only if you last selected the 6x8 font; otherwise it could be 48 or 72 pixels from the left border.

Font Selection

ESC [0 m	Normal mode
ESC [7 m	Reverse mode
ESC # 4	Large font: subsequent characters are written on the current row and the row below it using the 12x16 font which allows for two rows of eight characters on the display.
ESC # 5	Normal font: subsequent characters are written using the 6x8 font, which allows for four rows of sixteen characters on the display.
ESC # 7	Medium font: subsequent characters are written using the 8x8 font, which allows for four rows of twelve characters on the display.

Clearing Display

ESC [0 K	From cursor position to end of line inclusive
ESC [1 K	From beginning of line to cursor position (not inclusive)
ESC [2 K	Entire line
ESC [0 J	From cursor position to end of display inclusive
ESC [1 J	From beginning of display to cursor position (not inclusive)
ESC [2 J	Entire display; moves cursor to upper left corner on display

LED and Beeper Control

ESC [0 q	Emit short High tone + short delay
ESC [1 q	Emit short Low tone + short delay
ESC [2 q	Emit long Low tone + short delay
ESC [3 q	Emit good read tone
ESC [4 q	Emit bad tx tone
ESC [5 q	Wait 100 ms
ESC [6 q	Turn on the green LED
ESC [7 q	Turn off the green LED
ESC [8 q	Turn on the red LED
ESC [9 q	Turn off the red LED

The LED control escape sequences are intended to activate the LEDs for short periods of time and can be used in combination with the Beeper. The LED and Beeper will be controlled by the system after the entire command sequence is interpreted.

Example:

ESC [6 q ESC [3 q ESC [7 q	Turns on the green LED, emits a good read tone, and turns off the green LED.
ESC [6 q ESC [5 q ESC [7 q	Turns on the green LED for 100 ms and then turns off the green LED.

Setting RTC

ESC [0 p <i>ddmm yy</i>	Set date to day, month, year
ESC [1 p <i>hhmm</i>	Set time to hours, minutes; seconds are automatically set to 00.

NOTES



Appendix A

Technical Specifications

The tables that follow contain Physical and Performance Characteristics, User Environment and Regulatory information. [Table 49](#) provides Standard Cable Pinouts.

Table 48. Technical Specifications

Item	Description	
Physical Characteristics		
Dimensions	Height: 212 mm Length: 110 mm Width: 74 mm	
Weight (without cable)	PD9330: 340g; PD9330-AR: 375g PM/PBT9300-XX: 405g; PM/PBT9300-ARXX, PM9300-DXX, PM9300-DKXX: 435g; PM9300-DARXX, PM9300-DKARXX: 465g	
Electrical Characteristics		
PD9330 models		
Voltage & Current	PD9330	PD9330-AR
Input Voltage	4.5 / 30 VDC	4.5 / 30 VDC
Input Current		
Operating (typical, scanning)	110 mA @ 4.5 V 105 mA @ 5 V 45 mA @ 12 V 25 mA @ 30 V	180 mA @ 4.5 V 170 mA @ 5 V 70 mA @ 12 V 40 mA @ 30 V
Operating (max, reading)	420 mA @ 4.5 V 360 mA @ 5 V 140 mA @ 12 V 65 mA @ 30 V	480 mA @ 4.5 V 420 mA @ 5 V 160 mA @ 12 V 80 mA @ 30 V
Idle/Standby (typical)	45 mA @ 4.5 V 40 mA @ 5 V 20 mA @ 12 V 12 mA @ 30 V	45 mA @ 4.5 V 40 mA @ 5 V 20 mA @ 12 V 12 mA @ 30 V

Item	Description
PBT9300 and PM9300 models	
Battery Type	Li-Ion battery pack
Charge time for full charge from full discharge	4 hours with external power supply adapter ^a
	Typical 10 hours with Host power (in this case no supply adapter is needed) ^a
Operating autonomy (continuous reading)	50,000 reads (typical)
Cradle consumption and DC input supply range	Volt 10-30 VDC; Power <8W ^b ; Max 500 mA when in host/bus powered mode ^b .

- a. Charge Times are much lower when battery is within daily typical operating condition.
 b. Typical input current measured under factory default configuration.

Performance Characteristics		
Light Source	Laser	
	PX9300-XX	PX9300-XXAR
Roll (Tilt) Tolerance	± 35°	± 10°
Pitch Tolerance	± 40°	± 60°
Skew (Yaw) Tolerance	± 65°	± 65°
Print Contrast Minimum	25% minimum reflectance	
Resolution	3 mils	7.5 mils
Scan Rate	104 (± 12) scans / sec	35 (± 5) scans / sec
Scan Angle	47° max	13.5° (± 0.7°) max
Depth of Field (Typical)		
Symbology	PX9X00-XX	
Code 39		
5 mils	1.5 - 28 cm / 0.6 - 11"	
7.5 mils	1.5 - 42 cm / 0.6 - 16.5"	
10 mils	2 - 50 cm / 0.8 - 19.7"	
20 mils	2 - 110 cm / 0.8 - 43.3"	
40 mils	2 - 160 cm / 0.8 - 63"	
EAN 13	2.5 - 65 cm / 1 - 25.6"	

Symbology	PX9X00-XXARXX
Code 39	
7.5 mils	9 - 50 cm / 3.5 - 19.7"
10 mils	14 - 85 cm / 5.5 - 33.5"
15 mils	15 - 155 cm / 5.9 - 61"
20 mils	15 - 220 cm / 5.9 - 86.6"
40 mils	20 - 340 cm / 7.9 - 133.9"
55 mils	25 - 420 cm / 9.8 - 165.4"
Reflective Label	
Code 39	
70 mils	Up to 9 m / 29 ft
100 mils	Up to 11.5 m / 37 ft

Note: the reading performances may change with different symbologies.

Decode Capability	
PM9300-XX	
GS1 Databar linear codes, UPC/EAN (A,E,13,8), UPC/EAN with P2/P5 Addons, UPC/EAN Coupons, ISBN, Code128, EAN128, Code39, Code39 Full ASCII, Code39 CIP, Code 32, Codabar, Interleaved 2 of 5, IATA, Industrial 2 of 5, Standard 2 of 5, Code11, MSI, Plessey, Code 93, Follet 2/5, Code 4, Code 5, Datalogic 2 of 5, Codablock F	
PM9300-XXARXX	
GS1 Databar linear codes, UPC/EAN, UPC/EAN with P2/P5 Addons, UPC/EAN Coupons, ISBN, Code128, EAN128, Code39, Code39 Full ASCII, Code 32, Codabar, Interleaved 2 of 5, Standard 2 of 5, MSI, Code 93	
Interfaces Supported^a	RS-232, Keyboard Wedge, and USB.

a. See "Interface Selection" on page 14 for a listing of available interface sets by model type.

Item	Description	
User Environment		
Operating Temperature	-4° to 122° F (-20° to +50° C)	
Storage Temperature	-40° to 158° F (-40° to 70° C)	
Humidity	0 to 95% non-condensing	
Drop Specifications	Scanner withstands >50 times 6.5' (2 m) drops to concrete	
Ambient Light Immunity	PX9300-XX 100,000 Lux	PX9300-XXARXX 43,000 Lux
Contaminants Spray/ Rain/Dust/Particulates	IP65	
ESD Level	20 KV	

Item	Description			
	Regulatory	PD9330 (Corded Models)	PBT9300	PM9300
Electrical Safety	UL 60950, CSA C22.2 No. 60950, IEC 60950	UL 60950, CSA C22.2 No. 60950, IEC 60950	UL 60950, CSA C22.2 No. 60950, IEC 60950	UL 60950, CSA C22.2 No. 60950, IEC 60950
EMI/RFI	North America (FCC) : Part 15 Class B; Canada (IC) : ICES-003 Class B; Russia (Gost); Euro- pean Union EMC Direc- tive; VCCI-Japan; Korean KCC; Taiwan EMC (BSMI); Australia (ACMA); Mexico (NOM Nyce)	North America (FCC) : Canada (IC); Russia (Gost); European Union R&TTE Directive; Japan; Korean KCC; Taiwan; Australia; Mexico	433 MHz model Europe - CE, Russia – Gost; Australia – Ctick; China – SRRC; Singa- pore – IDA, Anatel Bra- zil 910 MHz model USA/Canada – FCC/IC; Mexico – NOM + Cofe- tel	
Laser Safety	IEC Class 2	IEC Class 2	IEC Class 2	IEC Class 2
Complies with FDA performance standards for laser products except for deviations pursuant to Laser Notice No. 50, dated June 24, 2007.				

Radio Features		
PBT9300		
Frequency Working Center	2400 to 2485.5MHz	
Range (in open air)	up to 100 m	
Max number of devices per base station	7	
PM9300		
Frequency Working Center	433 MHz	910 MHz
Programmable Speed	19.2 kb/s 115.2 kb/s 500 kb/s (default)	36.8 kb/s 500 kb/s (default)
Typical Range (in open air)	50 m (at 500 kb/s) 100 m (at 500 kb/s)	150 m (at 500 kb/s) 400 m (at 36.8 kb/s, frequency hopping) 50 m (at 36.8 kb/s, fixed channel)
Max number of devices per base station	16	

Imager Labeling

Sample labels are shown for illustrative purposes only. Please view the labels on your product for actual details, as they may vary from those depicted.

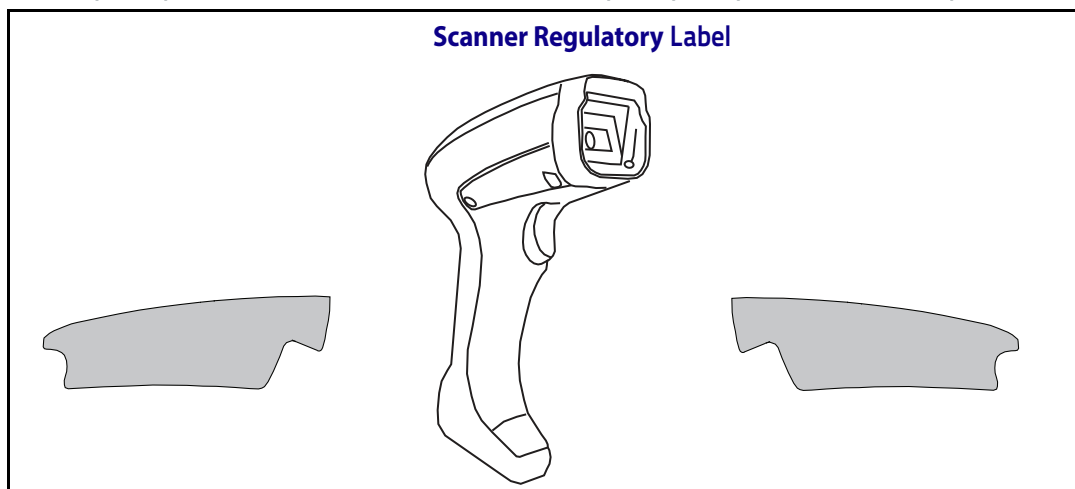

Standard Cable Pinouts

The data below provides standard pinout information for the interface cable.

Figure 11. Standard Cable Pinouts: Handheld

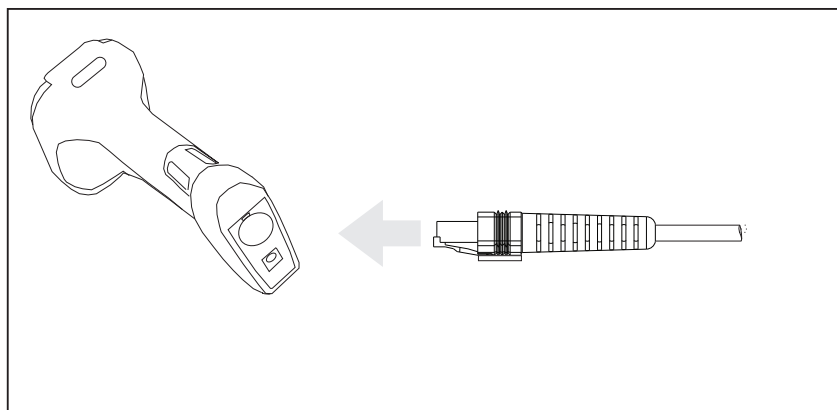

The signal descriptions in [Table 49](#) apply to the connector on the reader and are for reference only.

Table 49. Standard Cable Pinouts

Pin	RS-232	USB	Keyboard Wedge
1	RTS (out)		
2		D+	CLKIN (KBD side)
3		D-	DATAIN (KBD side)
4	GND	GND	GND
5	RX		
6	TX		
7	VCC	VCC	VCC
8			CLKOUT (PC side)
9			DATAOUT (PC side)
10	CTS (in)		

LED and Beeper Indications

The reader's beeper sounds and its LED illuminates to indicate various functions or errors on the reader. An optional "Green Spot" also performs useful functions. The tables below list these indications. One exception to the behaviors listed in the tables is that the reader's functions are programmable, and may or may not be turned on. For example, certain indications such as the power-up beep can be disabled using programming bar code labels.

Table 50. LED and Beeper Indications

INDICATION	DESCRIPTION	LED	BEEPER
Power-up Beep	The reader is in the process of powering-up.		Reader beeps four times at highest frequency and volume upon power-up.
Good Read Beep	A label has been successfully scanned by the reader.	LED behavior for this indication is configurable via the feature 'Good Read: When to Indicate'	The reader will beep once at current frequency, volume, tonal setting and duration upon a successful label scan.
Green Spot ^a flashes momentarily	Upon successful read of a label, the software turns the green spot on for the time specified by the configured value.	N/A	N/A

a. Except when in sleep mode or when a [Good Read LED Duration](#) other than 00 is selected

Table 51. Programming Mode Indications

Programming Mode - The following indications ONLY occur when the reader is in Programming Mode.

INDICATION	DESCRIPTION	LED	BEEPER
Label Programming Mode Entry	A valid programming label has been scanned.	LED blinks continuously	Reader sounds four low frequency beeps.
Label Programming Mode Rejection of Label	A label has been rejected.	N/A	Reader sounds three times at lowest frequency & current volume.
Label Programming Mode Acceptance of Partial Label	In cases where multiple labels must be scanned to program one feature, this indication acknowledges each portion as it is successfully scanned.	N/A	Reader sounds one short beep at highest frequency & current volume.

Programming Mode Indications (continued)			
INDICATION	DESCRIPTION	LED	BEEPER
Label Programming Mode Acceptance of Programming	Configuration option(s) have been successfully programmed via labels and the reader has exited Programming Mode.	N/A	Reader sounds one high frequency beep and 4 low frequency beeps followed by reset beeps.
Label Programming Mode Cancel Item Entry	Cancel label has been scanned.	N/A	Reader sounds two times at low frequency and current volume.

Base Station Indications (Cordless Models ONLY)

Base Station Button Indicators

BUTTON PUSH EVENT	CORDLESS	RED INDICATOR(**)	GREEN INDICATOR(**)
Push at power-up	force device connection (Aladdin)	Off	Slow blink Fast blink
< 5 sec	Paging	Off	Fast blink
5 to 10 sec	Unlink (Only Bluetooth)	Off	Slow blink



Appendix B Sample Bar Codes

The sample bar codes in this appendix are typical representations for their symbology types.

1D Bar Codes

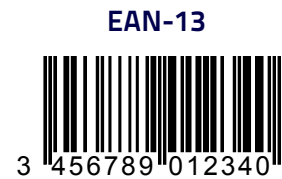
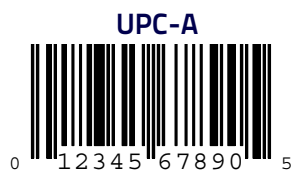

Interleaved 2 of 5



Code 32

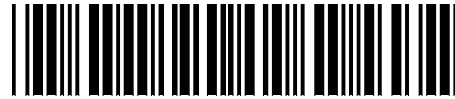

Codabar

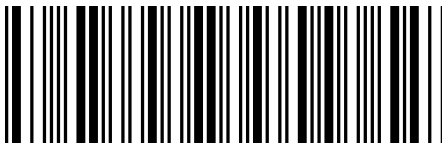

Code 93

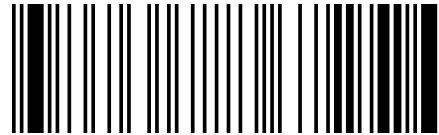

Code 11



GS1 DataBar (RSS)



GS1 DataBar variants must be enabled to read the bar codes below.



10293847560192837465019283746029478450366523
(GS1 DataBar Expanded Stacked)



1234890hjio9900mnb
(GS1 DataBar Expanded)



08672345650916
(GS1 DataBar Limited)

GS1 DataBar-14



55432198673467
(GS1 DataBar Omnidirectional Truncated)



90876523412674
(GS1 DataBar Omnidirectional Stacked)



78123465709811
(GS1 DataBar Omnidirectional Stacked)

NOTES



Appendix C Standard Defaults

The most common configuration settings are listed in the “Default” column of the table below. Page references are also provided for feature descriptions and programming bar codes for each parameter. A column has also been provided for recording of your preferred default settings for these same configurable features.

Table 52. Standard Defaults

Parameter	Default	Your Setting	Page Number
GLOBAL INTERFACE FEATURES			
Host Commands — Obey/Ignore	Obey		23
	Disable		23
RS-232 ONLY			
Baud Rate	115200		26
Stop Bits	1 Stop Bit		27
Parity	None		27
Handshaking Control	RTS		28
RS-232/USB-Com			
Intercharacter Delay	No Delay		30
Beep On ASCII BEL	Disable		30
Beep On Not on File	Enable		31
ACK NAK Options	Disable		31
ACK Character	'ACK'		32
NAK Character	'NAK'		32
ACK NAK Timeout Value	200 ms		33
ACK NAK Retry Count	3 Retries		33
ACK NAK Error Handling	Ignore Errors Detected		34
Indicate Transmission Failure	Enable		34

Parameter	Default	Your Setting	Page Number
Disable Character	'D'		35
Enable Character	'E'		35
KEYBOARD WEDGE			
Country Mode	U.S. Keyboard		38
Send Control Characters	00		41
Wedge Quiet Interval	100 ms		42
Intercode Delay	No Delay		42
Caps Lock StateCaps Lock State	Caps Lock OFF		43
Numlock	NumLock Key Unchanged		43
USB Keyboard Speed	1 ms		44
USB Keyboard Numeric Keypad	Standard Keys		45
USB-OEM			
USB-OEM Device Usage	Handheld		48
Interface Options	Ignore Scanner Configuration Host Commands		48
Data Format			
Global Prefix/Suffix (Header/Terminator)	No Global Prefix Global Suffix = 0x0D (CR)		50
Global AIM ID	Disable		51
Set AIM ID Individually for GS1-128	Enable		53
Label ID: Pre-Loaded Sets	EU Set		54
Label ID Control	Disable		55
Label ID Symbology Selection	N/A		56
Case Conversion	Disable		61
Character Conversion	No Char Conversion		62
READING PARAMETERS			
Double Read Timeout	0.6 Second		64
Power On Alert	Power-up Beep		66
Good Read: When to Indicate	After Decode		66
Good Read Beep Type	Mono		67
Good Read Beep Frequency	High		67
Good Read Beep Length	80 ms		68
Good Read Beep Volume	High		69

Parameter	Default	Your Setting	Page Number
Good Read LED Duration	300 ms		70
Scanning Features			
Scan Mode	Trigger Single		71
Scanning Active Time	5 seconds		72
Flash On Time	Flash on for 1 second		72
Flash Off Time	Flash is OFF for 600 ms		73
Aiming Pointer	Enable		73
Green Spot Duration	300 ms		74
CODE SELECTION - SYMBOLOGIES			
Code EAN/UPC			
Coupon Control	Enable only UPC/EAN		78
UPC-A			
UPC-A Enable/Disable	Enable		79
UPC-A Check Character Transmission	Send		79
Expand UPC-A to EAN-13	Don't Expand		80
UPC-A Number System Character Transmission	Transmit		80
In-Store Minimum Reads	2		81
UPC-E			
UPC-E Enable/Disable	Enable		82
UPC-E Check Character Transmission	Send		82
Expand UPC-E to EAN-13	Don't Expand		83
Expand UPC-E to UPC-A	Don't Expand		83
UPC-E Number System Character Transmission	Transmit		84
UPC-E Minimum Read	2		84
GTIN			
GTIN Formatting	Disable		85
EAN 13 (Jan 13)			
EAN 13 Enable/Disable	Enable		85
EAN 13 Check Character Transmission	Send		86
EAN-13 Flag 1 Character	Transmit		86
EAN-13 ISBN Conversion	Disable		86

Parameter	Default	Your Setting	Page Number
ISSN			
ISSN Enable/Disable	Disable		87
EAN 13 Minimum Reads	1		87
EAN 8			
EAN 8 Enable/Disable	Enable		88
EAN 8 Check Character Transmission	Send		88
EAN 8 to EAN 13	Disable		89
EAN 8 Minimum Reads	1		89
UPC/EAN Global Settings			
UPC/EAN Decoding Levels	3		90
UPC/EAN Price Weight Check	Disable		91
UPC-A Minimum Reads	1		92
UPC/EAN Quiet Zones	Two Modules		92
Add-Ons			
Optional Add-ons	Disable P2 and P5		93
Optional Add-On Timer	70 ms		94
P2 Add-Ons Minimum Reads	2		95
P5 Add-Ons Minimum Reads	1		96
Code 39			
Code 39 Enable/Disable	Enable		97
Code 39 Check Character Calculation	Don't Calculate		97
Code 39 Check Character Transmission	Send		98
Code 39 Start/Stop Character Transmission	Don't Transmit		99
Code 39 Full ASCII	Disable		99
Code 39 Quiet Zones	Auto		100
Code 39 Minimum Reads	2		101
Code 39 Decoding Levels	3		102
Code 39 Length Control	Variable		103
Code 39 Set Length 1	2		104
Code 39 Set Length 2	50		105
Code 39 Interdigit Ratio	4		106

Parameter	Default	Your Setting	Page Number
Code 32 (Italian Pharmaceutical Code)			
Code 32 Enable/Disable	Disable		107
Code 32 Check Character Transmission	Don't Send		107
Code 32 Start/Stop Character Transmission	Don't Transmit		108
Code 39 CIP (French Pharmaceutical Code) (Only Standard Optic Models)			
Code 39 CIP Enable/Disable	Disable		108
Code 128			
Code 128 Enable/Disable	Enable		109
Expand Code 128 to Code 39	Don't Expand		109
Code 128 Check Character Transmission	Don't Send		110
Code 128 Function Character Transmission	Don't Send		110
Code 128 Sub-Code Exchange Transmission	Disable		111
Code 128 Quiet Zones	Auto		111
Code 128 Minimum Reads	1		112
Code 128 Decoding Levels	3		113
Code 128 Length Control	Variable		114
Code 128 Set Length 1	1		115
Code 128 Set Length 2	80		116
GS1-128			
GS1-128 Enable	Transmit in GS1- 128 Data Format		117
CODE ISBT 128			
ISBT 128 Concatenation	Disable		118
ISBT 128 Force Concatenation	Disable		118
ISBT 128 Concatenation Mode	Static		119
ISBT 128 Dynamic Concatenation Timeout	200 msec		120
Interleaved 2 of 5			
I 2 of 5 Enable/Disable	Disable		121
I 2 of 5 Check Character Calculation	Disable		122
I 2 of 5 Check Character Transmission	Send		123
I 2 of 5 Minimum Reads	2		123

Parameter	Default	Your Setting	Page Number
I 2 of 5 Decoding Levels	3		124
I 2 of 5 Length Control	Variable		125
I 2 of 5 Set Length 1	6		126
I 2 of 5 Set Length 2	50		127
I 2 of 5 Zero Pattern	Disable		128
Interleaved 2 of 5 CIP HR			
Interleaved 2 of 5 Enable/Disable	Disable		129
Datalogic 2 of 5			
Datalogic 2 of 5 Enable/Disable	Disable		130
Datalogic 2 of 5 Check Character Calculation	Disable		130
Datalogic 2 of 5 Check Character Transmission	Send		131
Datalogic 2 of 5 Minimum Reads	2		131
Datalogic 2 of 5 Decoding Levels	Refer to I 2 of 5 Decoding Levels on page 124		130
Datalogic 2 of 5 Length Control	Variable		132
Datalogic 2 of 5 Set Length 1	06		132
Datalogic 2 of 5 Set Length 2	50		133
Datalogic 2 of 5 Interdigit Maximum Ratio	4		134
Follett 2 of 5 (Only standard optic models)			
Follett 2 of 5 Enable/Disable	Disable		135
Standard 2 of 5			
Standard 2 of 5 Enable/Disable	Disable		136
Standard 2 of 5 Check Character Calculation	Disable		136
Standard 2 of 5 Check Character Transmission	Send		137
Standard 2 of 5 Minimum Reads	2		137
Standard 2 of 5 Decoding Levels	Refer to I 2 of 5 Decoding Levels on page 124		138
Standard 2 of 5 Length Control	Variable		138
Standard 2 of 5 Set Length 1	8		139
Standard 2 of 5 Set Length 2	50		140

Parameter	Default	Your Setting	Page Number
Industrial 2 of 5 (Only standard optic models)			
Industrial 2 of 5 Enable/Disable	Disable		141
Industrial 2 of 5 Check Character Calculation	Disable		141
Industrial 2 of 5 Check Character Transmission	Enable		142
Industrial 2 of 5 Length Control	Variable		142
Industrial 2 of 5 Set Length 1	1		143
Industrial 2 of 5 Set Length 2	50		144
Industrial 2 of 5 Minimum Reads	1		145
Code IATA (Only standard optic models)			
IATA Enable/Disable	Disable		146
IATA Check Character Transmission	Enable		146
Codabar			
Codabar Enable/Disable	Disable		147
Codabar Check Character Calculation	Don't Calculate		147
Codabar Check Character Transmission	Send		148
Codabar Start/Stop Character Transmission	Transmit		148
Codabar Start/Stop Character Set	abcd/abcd		149
Codabar Start/Stop Character Match	Don't Require Match		149
Codabar Quiet Zones	Auto		150
Codabar Minimum Reads	1		151
Codabar Decoding Levels	3		152
Codabar Length Control	Variable		153
Codabar Set Length 1	3		154
Codabar Set Length 2	50		155
Codabar Interdigit Ratio	4		156
ABC Codabar			
ABC Codabar Enable/Disable	Disable		158
ABC Codabar Concatenation Mode	Static		158
ABC Codabar Dynamic Concatenation Timeout	N/A		159
ABC Codabar Force Concatenation	Disable		159

Parameter	Default	Your Setting	Page Number
Code 11 (Only standard optic models)			
Code 11 Enable/Disable	Disable		160
Code 11 Check Character Calculation	Check C and K		160
Code 11 Check Character Transmission	Send		161
Code 11 Minimum Reads	2		161
Code 11 Length Control	Variable		162
Code 11 Set Length 1	4		163
Code 11 Set Length 2	50		164
Code 11 Interdigit Ratio	4		165
Code 11 Decoding Levels	3		167
GS1 DataBar™ Omnidirectional			
GS1 DataBar™ Omnidirectional Enable/Disable	Disable		168
GS1 DataBar™ Omnidirectional GS1-128 Emulation	Disable		168
GS1 DataBar™ Omnidirectional Minimum Reads	1		169
GS1 DataBar™ Expanded			
GS1 DataBar™ Expanded Enable/Disable	Disable		170
GS1 DataBar™ Expanded GS1-128 Emulation	Disable		170
GS1 DataBar™ Expanded Minimum Reads	1		171
GS1 DataBar™ Expanded Length Control	Variable		172
GS1 DataBar™ Expanded Set Length 1	1		173
GS1 DataBar™ Expanded Set Length 2	74		174
GS1 DataBar™ Limited			
GS1 DataBar™ Limited Enable/Disable	Disable		175
GS1 DataBar™ Limited GS1-128 Emulation	Disable		175
GS1 DataBar™ Limited Minimum Reads	1		176
Code 93			
Code 93 Enable/Disable	Disable		177
Code 93 Check Character Calculation	Enable Check C and K		177
Code 93 Check Character Transmission	Enable		178
Code 93 Length Control	Variable		178

Parameter	Default	Your Setting	Page Number
Code 93 Set Length 1	1		179
Code 93 Set Length 2	50		180
Code 93 Minimum Reads	1		181
Code 93 Decoding Levels	3		182
Code 93 Quiet Zones	Auto		183
Codabloc F			
Codablock F Enable/Disable	Disable		184
Codablock F EAN Enable/Disable	Disable		184
Codablock F AIM Check	AIM compliant		185
Codablock F Length Control	Variable		185
Codablock F Set Length 1	3		186
Codablock F Set Length 2	100		187
Code 4			
Code 4 Enable/Disable	Disable		188
Code 4 Check Character Transmission	Send		188
Code 4 Hex to Decimal Conversion	Enable		189
Code 5			
Code 5 Enable/Disable	Disable		190
Code 5 Check Character Transmission	Send		190
Code 5 Hex to Decimal Conversion	Enable		191
Code 4 and 5 Common Configuration Items			
Code 4 and 5 Decoding Levels	3		192
Code 4 and Code 5 Minimum Reads	1		193
BC412			
BC412 Enable/Disable	Disable		194
BC412 Check Character Calculation	Don't Calculate		194
BC412 Minimum Reads	1		195
BC412 Decoding Levels	3		196
BC412 Length Control	Variable		197
BC412 Set Length 1	4		198
BC412 Set Length 2	50		199
MSI			
MSI Enable/Disable	Disable		200

Parameter	Default	Your Setting	Page Number
MSI Check Character Calculation	Enable Mod10		200
MSI Check Character Transmission	Enable		201
MSI Length Control	Variable		201
MSI Set Length 1	1		202
MSI Set Length 2	50		203
MSI Minimum Reads	4		204
MSI Decoding Levels	3		205
Plessey (Only standard optic models)			
Plessey Enable/Disable	Disable		206
Plessey Check Character Calculation	Enable Plessey std. check char. verification		206
Plessey Check Character Transmission	Enable		207
Plessey Length Control	Variable		207
Plessey Set Length 1	1		208
Plessey Set Length 2	50		209
Plessey Minimum Reads	4		210
Plessey Decoding Levels	3		211
Wireless Features			
Good Transmission Beep	Enable		217
Beep Frequency	Low		217
Beep Duration	80 msec		218
Beep Volume	High		219
Disconnect Beep	Enable		219
Leash Alarm	Disable		220
Automatic Configuration Update	Enable		222
Copy Configuration to Scanner	N/A		223
Copy Configuration to Base Station	N/A		223
Batch Mode	Disable		224
Send Batch	N/A		225
Erase Batch Memory	N/A		225
RF Batch Mode Transmit Delay	No Delay		226
Direct Radio Autolink	Unlink Label Required		227
Source Radio Address Transmission	Do not include		227

Parameter	Default	Your Setting	Page Number
Source Radio Address Delimiter Character	No Delimiter Character		228
Current Date	YYMMDD		229
Current Time	HHMMSS		229
Date Tx Format	YYYY-MM-DD (ISO 8601)		230
Time Tx Format	hh:mm:ss (ISO 8601)		231
Date-Time Separator	Disable		231
Date-Time Transmission Order	Disable		232
Powerdown Timeout	30 minutes		233
Features for PBT9300 Models Only			
Bluetooth Security Mode	Disable		235
Select PIN Code Length	4-Character		235
Set PIN Code			235
Set PIN Code	1234		236
Reconnect Attempt Interval	Indefinitely		237
Bluetooth HID Variable PIN Code	Static		238
Bluetooth HID Alt Mode	Off		239
Bluetooth Max Client	2		239
Bluetooth Friendly Name	[SERIAL_NUMBER_SCANNER]		241
Bluetooth Reconnect Attempt Mode	Enable		242
HID Country Mode	US		243
Features for PM9300 Models Only			
STAR Radio Protocol Timeout	02		247
STAR Radio Transmit Mode	Ack from cradle		248
Radio Sleep	Enable		249
Changing System Speed	High Speed		250
Frequency Agility	Use default fixed channel		251
Display and Keyboard Features			
Display Operating Mode	Display not cleared		252
Display Off Timeout	8 second delay		253
Backlight Enable	Disable		254
Display Contrast	N/A		255

Parameter	Default	Your Setting	Page Number
Font Size	Small		255
Enable/Disable Buttons	All keys enabled		256
Arrow Keys Mode (4-key models only)	Function Keys Action Select mode		258
Configure Custom Label String for Arrow Up Key (4-key models only)	N/A		259
Configure Custom Label String for Arrow Down Key (4-key models only)	N/A		259
Configure Actions for F1	No Actions Configured		261
Configure Actions for F2	No Actions Configured		262
Configure Actions for F3 (16-key models only)	No Actions Configured		263
Configure Actions for F4 (16-key models only)	No Actions Configured		263
Configure Actions for Shift (16-key models only)	No Actions Configured		264
Define Strings	N/A		265
Set String ID	N/A		266
Set String Header	No Header		266
Set String Terminator	No Terminator		267
Last Code Shown Timeout	N/A		268
Display Time Stamping Mode	Applied to both		269
Mode Selection	Set Normal Mode		270
Quantity Field	Transmit code with default qty (1)		271
Quantity/Code Send Mode	Qty precedes Code		272
Quantity/Code Separator	No separator		273
Interkey Timeout	1.0 seconds		274
Append Code	Overwrite always		275
Echo	Full Keypad echo		276
Keypress Sound	Enable		277
SHIFT Enable/Disable	Enable SHIFT function		277
SHIFT Key Association	Associate SHIFT to ↑		278
Lower Case	Disable Lower Case		279
Set F1 Label	N/A		280
Set F2 Label	N/A		280

Parameter	Default	Your Setting	Page Number
Set F3 Label	N/A		281
Set F4 Label	N/A		281
Barcode/Key Different Data Format	Disable		282
Set Barcode Header	N/A		282
Set Barcode Terminator	N/A		283
Set Key Sequence ID	N/A		283
Set Key Sequence Header	N/A		283
Set Key Sequence Terminator	N/A		284

Restore Factory Configuration

If you want to restore the Factory Configuration for your imager, scan either the Restore USA Factory Configuration bar code or the Restore EU Factory Configuration bar code below. Both labels restore the scanner configuration to the factory settings, including the interface type.



Scanning either of the “Restore Factory Configuration” commands below will result in the loss of any custom configuration settings for your device. Go to [Restore Custom Defaults on page 17](#) if you want to restore your custom configuration settings.

The USA label restores Label IDs to those historically used in the USA. The EU label restores Label IDs to those historically used in Europe. The Label ID sets for USA and EU are shown in [Label ID: Pre-loaded Sets, starting on page 302](#) of this manual.



Restore USA Factory Configuration



Restore EU Factory Configuration



Appendix D Keypad

Use the bar codes in this appendix to enter numbers as you would select digits/characters from a keypad.



0



1



2

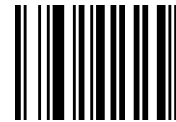

3



4



5

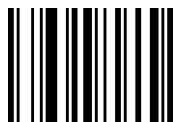

6

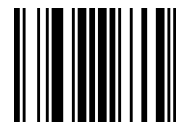

7

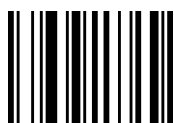

8



9

Keypad (continued)



A

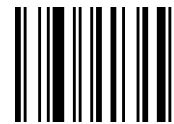

B



C



D



E



F

Make a mistake? Scan the CANCEL bar code to abort and not save the entry string. You can then start again at the beginning.



CANCEL



Appendix E

Scancode Tables

Control Character Emulation

Control character emulation selects from different scancode tables as listed in this appendix. Each of the control character sets below are detailed by interface type in the tables. These apply to Wedge and USB Keyboard platforms.

Control Character 00: Characters from 00 to 0x1F are sent as control character Ctrl+Keys, special keys are located from 0x80 to 0xA1.

Control Character 01: Characters from 00 to 0x1F are sent as control character Ctrl+Capital Key, special keys are located from 0x80 to 0xA1.

Control Character 02: Special keys are located from 00 to 0x1F and characters from 0x80 to 0xFE are intended as an extended ASCII table.

Single Press and Release Keys

In the following tables, Ar↓ means Alt right pressed and Ar↑ means Alt right released and so on. Definitions for other keys are Al (Alt left), Cr (Control Right), Cl (Control Left), Sh (shift). This method can be used for combining Alt, Control or Shift with other keys.

Example: Consider a Control character set to 00. If AltRight+A is required before sending a label to the host, it could be done by setting three Prefix keys in this way: 0x99 0x41 0x9A.

Interface Type PC AT PS/2, USB-Keyboard

Table 53. Scancode Set When Control Character is 00 or 01

	x0	x1	x2	x3	x4	x5	x6	x7	x8	x9	xA	xB	xC	xD	xE	xF
0x	NULL C+@	SOH C(S)+A	STX C(S)+B	ETX C(S)+C	EOT C(S)+D	ENQ C(S)+E	ACK C(S)+F	BEL C(S)+G	BS	HT TAB	LF C(S)+J	VT C(S)+K	FF C(S)+L	CR Enter	SO C(S)+N	SI C(S)+O
1x	DLE C(S)+P	DC1 C(S)+Q	DC2 C(S)+R	DC3 C(S)+S	DC4 C(S)+T	NAK C(S)+U	SYN C(S)+V	ETB C(S)+W	CAN C(S)+X	EM C(S)+Y	SUB C(S)+Z	ESC Esc	FS C+\	GS C+]	RS C+^	US C(S)+_
2x	SP	!	"	#	\$	%	&	'	()	*	+	,	-	.	/
3x	0	1	2	3	4	5	6	7	8	9	:	;	<	=	>	?
4x	@	A	B	C	D	E	F	G	H	I	J	K	L	M	N	O
5x	P	Q	R	S	T	U	V	W	X	Y	Z	[\]	^	_
6x	`	a	b	c	d	e	f	g	h	i	j	k	l	m	n	o
7x	p	q	r	s	t	u	v	w	x	y	z	{		}	~	Del
8x	€	Sh↓	Sh↑	Ins	Ent (keyp)	F1	F2	F3	F4	F5	F6	F7	F8	F9	F10	F11
9x	F12	Home	End	Pg Up	Pg Dwn	↑	↓	←	→	Ar↓	Ar↑	Al↓	Al↑	Cl↓	Cl↑	Cr↓
Ax	Cr↑		‘	f	„	...	†	‡	^	%	Š	<	Ś	<	Œ	
Bx	°	±	²	³	´	µ	¶	·	,	ı	°	»	¼	½	¾	¿
Cx	À	Á	Â	Ã	Ä	Å	Æ	Ç	È	É	Ê	Ë	Ì	Í	Î	Ï
Dx	Ð		Ò	Ó	Ô	Õ	Ö	×	Ø	Ù	Ú	Û	Ü	Ý	Þ	ß
Ex	à	á	â	ã	ä	å	æ	ç	è	é	ê	ë	ì	í	î	ï
Fx	ð	ñ	ò	ó	ô	õ	ö	÷	ø	ù	ú	û	ü	ý	þ	ÿ

Extended characters (sky blue) are sent through dedicated keys (when available in the selected country mode) or by using an Alt Mode sequence.

Interface Type PC AT PS/2, USB-Keyboard (continued)

Table 54. Scancode Set When Control Character is 02

	x0	x1	x2	x3	x4	x5	X6	x7	x8	x9	xA	xB	xC	xD	xE	xF
0x	Ar↓	Ar↑	Al↓	Al↑	Cl↓	Cl↑	Cr↓	Cr↑	BS	Tab	→	S+ Tab	Enter Keyprd	Enter	Ins	Pg Up
1x	Pg Dwn	Home	←	↓	↑	F6	F1	F2	F3	F4	F5	ESC	F7	F8	F9	F10
2x	Space	!	“	#	\$	%	&	‘	()	*	+	,	-	.	/
3x	0	1	2	3	4	5	6	7	8	9	:	;	<	=	>	?
4x	@	A	B	C	D	E	F	G	H	I	J	K	L	M	N	O
5x	P	Q	R	S	T	U	V	W	X	Y	Z	[\]	^	_
6x	`	a	b	c	d	e	f	g	h	i	j	k	l	m	n	o
7x	p	q	r	s	t	u	v	w	x	y	z	{		}	~	Del
8x	€		‘	f	„	…	†	‡	^	%	Š	<	Ś	<	Œ	
9x		‘	’	“	”	•	–	—	~	™	š	>	œ		ž	ÿ
Ax	NBSP	ı	ç	£	¤	¥	¦	§	¨	©	ª	«	¬	-	®	¯
Bx	°	±	²	³	´	µ	¶	·	,	ı	°	»	¼	½	¾	¿
Cx	À	Á	Â	Ã	Ä	Å	Æ	Ç	È	É	Ê	Ë	Ì	Í	Î	Ï
Dx	Ð		Ò	Ó	Ô	Õ	Ö	×	Ø	Ù	Ú	Û	Ü	Ý	Þ	ß
Ex	à	á	â	ã	ä	å	æ	ç	è	é	ê	ë	ì	í	î	ï
Fx	ð	ñ	ò	ó	ô	õ	ö	÷	ø	ù	ú	û	ü	ý	þ	ÿ

Interface Type PC AT PS/2 Alt Mode or USB-Keyboard Alt Mode

Table 55. Scancode Set When Control Character is 00 or 01

	x0	x1	x2	x3	x4	x5	X6	x7	x8	x9	xA	xB	xC	xD	xE	Xf
0x	Alt+000	Alt+001	Alt+002	Alt+003	Alt+004	Alt+005	Alt+006	Alt+007	BS	HT TAB	Alt+010	Alt+011	Alt+012	CR Enter	Alt+014	Alt+015
1x	Alt+016	Alt+017	Alt+018	Alt+019	Alt+020	Alt+021	Alt+022	Alt+023	Alt+024	Alt+025	Alt+026	ESC Esc	Alt+028	Alt+029	Alt+030	Alt+031
2x	A+032	A+033	A+034	A+035	A+036	A+037	A+038	A+039	A+040	A+041	A+042	A+043	A+044	A+045	A+046	A+047
3x	A+048	A+049	A+050	A+051	A+052	A+053	A+054	A+055	A+056	A+057	A+058	A+059	A+060	A+061	A+062	A+063
4x	A+064	A+065	A+066	A+067	A+068	A+069	A+070	A+071	A+072	A+073	A+074	A+075	A+076	A+077	A+078	A+079
5x	A+080	A+081	A+082	A+083	A+084	A+085	A+086	A+087	A+088	A+089	A+090	A+091	A+092	A+093	A+094	A+095
6x	A+096	A+097	A+098	A+099	A+100	A+101	A+102	A+103	A+104	A+105	A+106	A+107	A+108	A+109	A+110	A+111
7x	A+112	A+113	A+114	A+115	A+116	A+117	A+118	A+119	A+120	A+121	A+122	A+123	A+124	A+125	A+126	A+127
8x	€	Sh↓	Sh↑	Ins	Ent (keyp)	F1	F2	F3	F4	F5	F6	F7	F8	F9	F10	F11
9x	F12	Home	End	Pg Up	Pg Dwn	↑	↓	←	→	Ar↓	Ar↑	Al↓	Al ↑	Cl ↓	Cl ↑	Cr ↓
Ax	Cr ↑	A+0161	A+0162	A+0163	A+0164	A+0165	A+0166	A+0167	A+0168	A+0169	A+0170	A+0171	A+0172	A+0173	A+0174	A+0175
Bx	A+0176	A+0177	A+0178	A+0179	A+0180	A+0181	A+0182	A+0183	A+0184	A+0185	A+0186	A+0187	A+0188	A+0189	A+0190	A+0191
Cx	A+0192	A+0193	A+0194	A+0195	A+0196	A+0197	A+0198	A+0199	A+0200	A+0201	A+0202	A+0203	A+0204	A+0205	A+0206	A+0207
Dx	A+0208	A+0209	A+0210	A+0211	A+0212	A+0213	A+0214	A+0215	A+0216	A+0217	A+0218	A+0219	A+0220	A+0221	A+0222	A+0223
Ex	A+0224	A+0225	A+0226	A+0227	A+0228	A+0229	A+0230	A+0231	A+0232	A+0233	A+0234	A+0235	A+0236	A+0237	A+0238	A+0239
Fx	A+0240	A+0241	A+0242	A+0243	A+0244	A+0245	A+0246	A+0247	A+0248	A+0249	A+0250	A+0251	A+052	A+0253	A+0254	A+0255

Interface Type PC AT PS/2 Alt Mode or USB-Keyboard Alt Mode (continued)

Table 56. Scancode Set When Control Character is 02

	x0	x1	x2	x3	x4	x5	X6	x7	x8	x9	xA	xB	xC	xD	xE	xF
0x	Ar↓	Ar↑	Al↓	Al↑	Cl↓	Cl↑	Cr↓	Cr↑	BS	Tab	→	S+ Tab	Enter Keypd	Enter	Ins	Pg Up
1x	Pg Dwn	Home	←	↓	↑	F6	F1	F2	F3	F4	F5	ESC	F7	F8	F9	F10
2x	A+032	A+033	A+034	A+035	A+036	A+037	A+038	A+039	A+040	A+041	A+042	A+043	A+044	A+045	A+046	A+047
3x	A+048	A+049	A+050	A+051	A+052	A+053	A+054	A+055	A+056	A+057	A+058	A+059	A+060	A+061	A+062	A+063
4x	A+064	A+065	A+066	A+067	A+068	A+069	A+070	A+071	A+072	A+073	A+074	A+075	A+076	A+077	A+078	A+079
5x	A+080	A+081	A+082	A+083	A+084	A+085	A+086	A+087	A+088	A+089	A+090	A+091	A+092	A+093	A+094	A+095
6x	A+096	A+097	A+098	A+099	A+100	A+101	A+102	A+103	A+104	A+105	A+106	A+107	A+108	A+109	A+110	A+111
7x	A+112	A+113	A+114	A+115	A+116	A+117	A+118	A+119	A+120	A+121	A+122	A+123	A+124	A+125	A+126	A+127
8x	A+0128	A+0129	A+0130	A+0131	A+0132	A+0133	A+0134	A+0135	A+0136	A+0137	A+0138	A+0139	A+0140	A+0141	A+0142	A+0143
9x	A+0144	A+0145	A+0146	A+0147	A+0148	A+0149	A+0150	A+0151	A+0152	A+0153	A+0154	A+0155	A+0156	A+0157	A+0158	A+0159
Ax	A+0160	A+0161	A+0162	A+0163	A+0164	A+0165	A+0166	A+0167	A+0168	A+0169	A+0170	A+0171	A+0172	A+0173	A+0174	A+0175
Bx	A+0176	A+0177	A+0178	A+0179	A+0180	A+0181	A+0182	A+0183	A+0184	A+0185	A+0186	A+0187	A+0188	A+0189	A+0190	A+0191
Cx	A+0192	A+0193	A+0194	A+0195	A+0196	A+0197	A+0198	A+0199	A+0200	A+0201	A+0202	A+0203	A+0204	A+0205	A+0206	A+0207
Dx	A+0208	A+0209	A+0210	A+0211	A+0212	A+0213	A+0214	A+0215	A+0216	A+0217	A+0218	A+0219	A+0220	A+0221	A+0222	A+0223
Ex	A+0224	A+0225	A+0226	A+0227	A+0228	A+0229	A+0230	A+0231	A+0232	A+0233	A+0234	A+0235	A+0236	A+0237	A+0238	A+0239
Fx	A+0240	A+0241	A+0242	A+0243	A+0244	A+0245	A+0246	A+0247	A+0248	A+0249	A+0250	A+0251	A+052	A+0253	A+0254	A+0255

ASCII Chart

ASCII Char.	Hex No.	ASCII Char.	Hex No.	ASCII Char.	Hex No.	ASCII Char.	Hex No.
NUL	00	SP	20	@	40	'	60
SOH	01	!	21	A	41	a	61
STX	02	,	22	B	42	b	62
ETX	03	#	23	C	43	c	63
EOT	04	\$	24	D	44	d	64
ENQ	05	%	25	E	45	e	65
ACK	06	&	26	F	46	f	66
BEL	07	'	27	G	47	g	67
BS	08	(28	H	48	h	68
HT	09)	29	I	49	i	69
LF	0A	*	2A	J	4A	j	6A
VT	0B	+	2B	K	4B	k	6B
FF	0C	,	2C	L	4C	l	6C
CR	0D	-	2D	M	4D	m	6D
SO	0E	.	2E	N	4E	n	6E
SI	0F	/	2F	O	4F	o	6F
DLE	10	0	30	P	50	p	70
DC1	11	1	31	Q	51	q	71
DC2	12	2	32	R	52	r	72
DC3	13	3	33	S	53	s	73
DC4	14	4	34	T	54	t	74
NAK	15	5	35	U	55	u	75
SYN	16	6	36	V	56	v	76
ETB	17	7	37	W	57	w	77
CAN	18	8	38	X	58	x	78
EM	19	9	39	Y	59	y	79
SUB	1A	:	3A	Z	5A	z	7A
ESC	1B	;	3B	[5B	{	7B
FS	1C	<	3C	\	5C		7C
GS	1D	=	3D]	5D	}	7D
RS	1E	>	3E	^	5E	~	7E
US	1F	?	3F	_	5F	DEL	7F



www.datalogic.com

©2013-2017 Datalogic S.p.A. and/or its affiliates. ■ All rights reserved.
Datalogic and the Datalogic logo are registered trademarks of Datalogic S.p.A. in many countries, including the U.S.A. and the E.U.

Datalogic USA, Inc.

959 Terry Street | Eugene, OR 97402 | USA
Telephone: (541) 683-5700 | Fax: (541) 345-7140

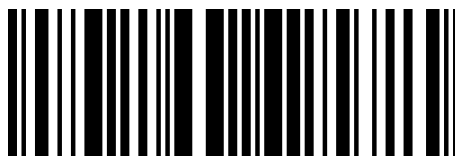

820092914

(Rev B)

May 2017